

**TM 11-6625-3081-23-3**

**TECHNICAL MANUAL  
ORGANIZATIONAL AND DIRECT SUPPORT  
MAINTENANCE MANUAL  
FOR  
ELECTRONIC EQUIPMENT TEST FACILITY  
TADS/PNVS AUGMENTATION EQUIPMENT**

**13082808-39, 13231600, 13231650 AND 13231800**

**WIRING DATA**

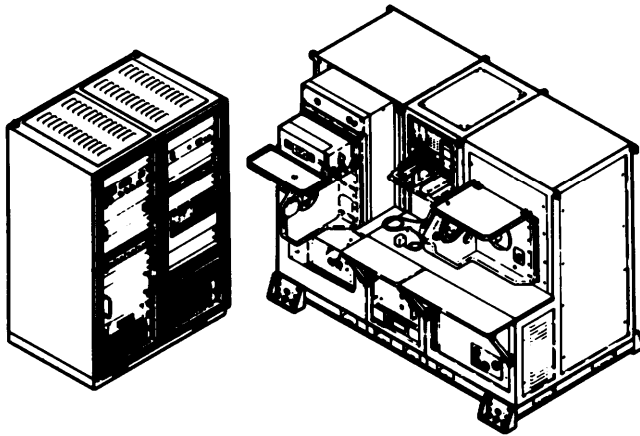

**MAJOR TEST ADAPTER (P 3-309)**

**TPS CABLES (P 3-379)**

**TPS SELF-TEST CONNECTORS (P 3-561)**

**TEST FIXTURES (P 3-667)**

**"Approved for public release; distribution is unlimited."**

**HEADQUARTERS, DEPARTMENT OF THE ARMY**

**1 FEBRUARY 1986**



Change

No. 19

HEADQUARTERS,  
DEPARTMENT OF THE ARMY  
Washington, D. C., 06 March 1997

ORGANIZATIONAL AND DIRECT SUPPORT  
MAINTENANCE MANUAL

ELECTRONIC EQUIPMENT TEST FACILITY  
TADS/PNVS AUGMENTATION EQUIPMENT

13082808-39, 13231600, 13231650 AND 13231800

DISTRIBUTION STATEMENT A: Approved for public release; distribution is unlimited.

TM 11-6625-3081-23-3, dated 01 February 1986, is changed as follows:

1. Remove and insert pages as indicated below. New or changed text material is indicated by a vertical bar in the margin. An illustration change is indicated by a miniature pointing hand.

Remove pages

A through C/(D blank)

3-379/(3-380 blank)

3-560.59/(3-560.60 blank)

3-563/(3-564 blank)

Insert pages

A through C/(D blank)

3-379/(3-380 blank)

3-560.59 through 3-560.61  
/(3-560.62 blank)

3-563/(3-564 blank)

3-666.9/(3-666.10 blank)

2. Retain this page in front of manual for reference purposes.

*By Order of the Secretary of the Army:*

Official

  
JOEL B. HUDSON

Administrative Assistant to the  
Secretary of the Army  
03960

**DENNIS J. REIMER**  
General, United States Army  
Chief of Staff

DISTRIBUTION:

To be distributed in accordance with DA Form 12-31-E, block no. 1811, requirements for TM 11-6625-3081-23-3.





Change)  
)  
No. 18 )

Washington, D.C., 31 July 1996

HEADQUARTERS  
DEPARTMENT OF THE ARMY

**ORGANIZATIONAL AND DIRECT SUPPORT  
MAINTENANCE MANUAL**

**ELECTRONIC EQUIPMENT TEST FACILITY  
TADS/PNVS AUGMENTATION EQUIPMENT  
13082808-39, 13231600, 13231650 AND 13231800**

**DISTRIBUTION STATEMENT A:** Approved for public release; distribution is unlimited.

TM 11-6625-3081-23-3, 1 February 1986 is changed as follows:

1. Remove and insert pages as indicated below. New or changed text material is indicated by a vertical bar in the margin. Changes in wiring diagrams are indicated by a shaded area.

	<u>Remove pages</u>	<u>Insert pages</u>
List of Effective Pages Chapter 3	A through C/(D blank) 3-560.7 through 3-560.14	A through C/(D blank) 3-560.7 through 3-560.14.1/ (3-560.14.2 blank)

2. Retain this sheet in front of manual for reference purposes.

By Order of the Secretary of the Army:

**DENNIS J. REIMER**  
*General, United States Army*  
*Chief of Staff*

Official:

**JOEL B. HUDSON**  
*Administrative Assistant to the*  
*Secretary of the Army*  
02454

**DISTRIBUTION:**

To be distributed in accordance with DA Form 12-31-E, block no. 1811, requirements for TM 11-6625-3081-23-3.

CHANGE

NO. 17

HEADQUARTERS  
DEPARTMENT OF THE ARMY  
WASHINGTON, D.C., 30 November 1993

ORGANIZATIONAL AND DIRECT SUPPORT  
MAINTENANCE MANUAL FOR ELECTRONIC EQUIPMENT  
TEST FACILITY TADS/PNVS AUGMENTATION EQUIPMENT

DISTRIBUTION STATEMENT A: Approved for public release; distribution is unlimited.

TM 11-6625-3081-23-3, 1 February 1986, is changed as follows:

1. Remove and insert pages as indicated below. New or changed text material is indicated by a vertical bar in the margin. An illustration change is indicated by a miniature pointing hand.

## Remove pages

A through D  
3-379/(3-380 blank)  
3-425 and 3-426  
3-427 through 3-458  
(3-501 blank)/3-502  
3-560.1 and 3-560.2  
3-561 and 3-563/(3-564 blank)  
(3-577 blank)/3-578  
3-606.1 and 3-606.2  
3-611/3-612 blank  
3-613 through 3-616  
3-617 and 3-618  
3-626.1 and 3-626.2  
3-629 through 3-646  
3-647 and 3-648  
3-648.1/(3-648.2 blank)  
3-653 and 3-654  
3-665 and 3-666

## Insert pages

A through C/(D blank)  
3-379/(3-380 blank)  
3-425/(3-426 blank)  
-----  
(3-501 blank)/3-502  
(3-560.1 blank)/3-560.2  
3-561 and 3-563/(3-564 blank)  
3-578  
(3-606.1 blank)/3-606.2  
3-611/(3-612 blank)  
-----  
(3-617 blank)/3-618  
3-626.1 and 3-626.2  
3-629 through 3-630  
3-647 and 3-648  
-----  
3-653 and 3-654  
3-665/(3-666 blank)

2. Retain this sheet in front of manual for reference purposes.

By Order of the Secretary of the Army:

Official:

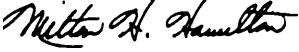
  
MILTON H. HAMILTON  
*Administrative Assistant to the  
Secretary of the Army*

05870

GORDON R. SULLIVAN  
*General, United States Army  
Chief of Staff*

DISTRIBUTION :

To be distributed in accordance with DA Form 12-31-E, block no. 1811, requirements for TM 11-6625-3081-23-3.

CHANGE  
NO. 16

HEADQUARTERS  
DEPARTMENT OF THE ARMY  
WASHINGTON, D.C., 30 July 1993

ORGANIZATIONAL, AND DIRECT SUPPORT  
MAINTENANCE MANUAL FOR ELECTRONIC EQUIPMENT  
TEST FACILITY TADS/PNVS AUGMENTATION EQUIPMENT

DISTRIBUTION STATEMENT A: Approved for public release; distribution is unlimited.

TM 11-6625-3081-23-3, 1 February 1986, is changed as follows:

1. Remove and insert pages as indicated below. New or changed text material is indicated by a vertical bar in the margin. An illustration change is indicated by a miniature pointing hand.

Remove pages	Insert pages
A through D	A through D
i/(ii blank)	i/(ii blank)
3-379/(3-380 blank)	3-379/(3-80 blank)
3-409 through 3-411/ (3-412 blank)	3-409 through 3-411/ (3-412 blank)
3-413 through 3-423/ (3-424 blank)	3-413 through 3-423/ (3-424 blank)
3-560.29 through 3-560.46	3-560.29 through 3-560.46
3-667 and 3-668	3-667/(3-668 blank)
3-671 through 3-678	3-671 through 3-678

2. Retain this sheet in front of manual for reference purposes.

By Order of the Secretary of the Army:

Official:

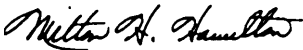
  
MILTON H. HAMILTON  
Administrative Assistant to the  
Secretary of the Army

04823

GORDON R. SULLIVAN  
General, United States Army  
Chief of Staff

DISTRIBUTION:

To be distributed in accordance with DA Form 12-31-E, block no. 1811, requirements for TM 11-6625-3081-23-3.



CHANGE

NO. 15

HEADQUARTERS  
DEPARTMENT OF THE ARMY  
WASHINGTON, D.C., 26 FEBRUARY 1993

ORGANIZATIONAL AND DIRECT SUPPORT  
MAINTENANCE MANUAL FOR ELECTRONIC EQUIPMENT  
TEST FACILITY TADS/PNVS AUGMENTATION EQUIPMENT

DISTRIBUTION STATEMENT A: Approved for public release; distribution is unlimited.

TM 11-6625-3081-23-3, 1 February 1986, is changed as follows:

1. Remove and insert pages as indicated below. New or changed text material is indicated by a vertical bar in the margin. An illustration change is indicated by a miniature pointing hand.

Remove pages

A through L  
3-429 and 3-430

Insert pages

A through D  
3-429 and 3-430

2. Retain this sheet in front of manual for reference purposes.

By Order of the Secretary of the Army:

GORDON R. SULLIVAN  
*General, United States Army*  
Chief of Staff

Official:

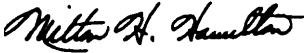
  
MILTON H. HAMILTON  
*Administrative Assistant to the  
Secretary of the Army*

DISTRIBUTION:

To be distributed in accordance with DA Form 12-31-E, block no. 1811, requirements for TM 11-6625-3081-23-3.



CHANGE }  
NO. 14 }

HEADQUARTERS  
DEPARTMENT OF THE ARMY  
WASHINGTON, D.C., 7 August 1991

ORGANIZATIONAL AND DIRECT SUPPORT  
MAINTENANCE MANUAL FOR ELECTRONIC EQUIPMENT  
TEST FACILITY TADS/PNVS AUGMENTATION EQUIPMENT

TM 11-6625-3081-23-3, 1 February 1986, is changed as follows:

1. Remove and insert pages as indicated below. New or changed text material is indicated by a vertical bar in the margin. An illustration change is indicated by a miniature pointing hand.

Remove pages

Insert pages

A through D  
3-666.3 and 3-666.4

A through D  
3-666.3 and 3-666.4

2. Retain this sheet in front of manual for reference purposes.

By Order of the Secretary of the Army:

GORDON R. SULLIVAN  
*General, United States Army*  
*Chief of Staff*

Official:

PATRICIA P. HICKERSON  
*Colonel, United States Army*  
*The Adjutant General*

DISTRIBUTION:

To be distributed in accordance with DA Form 12-31-E, block no. 1811, Organizational and Direct Support maintenance requirements for TM 11-6625-3081-23-3.





CHANGE }  
NO. 13 }HEADQUARTERS  
DEPARTMENT OF THE ARMY  
WASHINGTON, D.C., 11 April 1991ORGANIZATIONAL AND DIRECT SUPPORT  
MAINTENANCE MANUAL FOR ELECTRONIC EQUIPMENT  
TEST FACILITY TADS/PNVS AUGMENTATION EQUIPMENT

TM 11-6625-3081-23-3, 1 February 1986, is changed as follows:

1. Remove and insert pages as indicated below. New or changed text material is indicated by a vertical bar in the margin. An illustration change is indicated by a miniature pointing hand.

Remove pages	Insert pages
A through D	A through D
3-311 and 3-312	3-311 and 3-312
3-331 and 3-332	3-331 and 3-332
3-335 and 3-336	3-335 and 3-336
3-339 and 3-340	3-339 and 3-340
3-355 and 3-356	3-355 and 3-356
3-371 and 3-372	3-371 and 3-372
3-561 and 3-562	3-561 and 3-562
3-575 and 3-578	3-575/3-576
- - - - -	3-578
- - - - -	3-579/3-580

2. Retain this sheet in front of manual for reference purposes.

**By Order of the Secretary of the Army:**

**CARL E. VUONO**  
*General, United States Army*  
*Chief of Staff*

**Official:**

**THOMAS F. SIKORA**  
*Brigadier General, United States Army*  
*The Adjutant General*

**DISTRIBUTION:**

To be distributed in accordance with DA Form 12-31-E, block 1811, Organizational and Direct Support maintenance requirements for TM 11-6625-3081-23-3.



CHANGE }  
 NO. 12 }

HEADQUARTERS  
 DEPARTMENT OF THE ARMY  
 WASHINGTON, D.C., 9 March 1991

ORGANIZATIONAL AND DIRECT SUPPORT  
 MAINTENANCE MANUAL FOR ELECTRONIC EQUIPMENT  
 TEST FACILITY TADS/PNVS AUGMENTATION EQUIPMENT  
 13082808-39, 13231600, 13231650 and 13231800  
 WIRING DATA

TM 11-6625-3081-23-3, 1 February 1986, is changed as follows:

1. Remove and insert pages as indicated below. New or changed text material is indicated by a vertical bar in the margin. An illustration change is indicated by a miniature pointing hand.

Remove pages	Insert pages
A through D	A through D
3-379/3-380	3-379/3-380
3-381 and 3-382	3-381 and 3-382
- - - -	3-383/3-384
3-459 through 3-462	3-459 through 3-462
3-465 and 3-466	3-465 and 3-466
3-502	3-502
3-533 through 3-536	3-533 through 3-536
3-560.15 through 3-560.18	3-560.15 through 3-560.18
3-560.21 through 3-560.24	3-560.21 through 3-560.24
3-560.27 and 3-560.28	3-560.27 and 3-560.28
3-560.31 through 3-560.34	3-560.31 through 3-560.34
3-560.39 and 3-560.40	3-560.39 and 3-560.40
3-560.43 and 3-560.44	3-560.43 and 3-560.44
3-560.47 through 3-560.52	3-560.47 through 3-560.52
3-560.55 through 3-560.60	3-560.55 through 3-560.59/ 3-560.60
3-560.61 through 3-560.66	- - - -
3-666.5 and 3-666.6	3-666.5 and 3-666.6

2. Retain this sheet in front of manual for reference purposes.

**By Order of the Secretary of the Army:**

**CARL E. VUONO**  
*General, United States Army*  
*Chief of Staff*

**Official:**

**THOMAS F. SIKORA**  
*Brigadier General, United States Army*  
*The Adjutant General*

**DISTRIBUTION:**

To be distributed in accordance with DA Form 12-31-E, block no 1811, Organizational and Direct Support maintenance requirements for TM 11-6625-3081-23-3.



CHANGE }  
NO. 11 }HEADQUARTERS  
DEPARTMENT OF THE ARMY  
WASHINGTON, D.C., 26 September 1990ORGANIZATIONAL AND DIRECT SUPPORT  
MAINTENANCE MANUAL FOR ELECTRONIC EQUIPMENT  
TEST FACILITY TADS/PNVS AUGMENTATION EQUIPMENT

TM 11-6625-3081-23-3, 1 February 1986, is changed as follows:

1. Remove and insert pages as indicated below. New or changed text material is indicated by a vertical bar in the margin. An illustration change is indicated by a miniature pointing hand,

## Remove pages

A through D  
3-381 and 3-382  
3-413 and 3-414  
3-427 through 3-430  
3-461 and 3-462  
3-502

## Insert pages

A through D  
3-381 and 3-382  
3-413 and 3-414  
3-427 through 3-430  
3-461 and 3-462  
3-502

2. Retain this sheet in front of manual for reference purposes.

**By Order of the Secretary of the Army:**

**Official:**

**THOMAS F. SIKORA**  
*Brigadier General, United States Army*  
*The Adjutant General*

**CARL E. VUONO**  
*General, United States Army*  
*Chief of Staff*

## DISTRIBUTION:

To be distributed in accordance with DA Form 12-31A, Organizational and Direct Support Maintenance Manual for Electronic Equipment Test Facility TADS/PNVS Augmentation Equipment 13082700 and 13082808-29.



CHANGE }  
NO. 10 }

HEADQUARTERS  
DEPARTMENT OF THE ARMY  
WASHINGTON, D.C., 6 June 1990

ORGANIZATIONAL AND DIRECT SUPPORT  
MAINTENANCE MANUAL FOR ELECTRONIC EQUIPMENT  
TEST FACILITY TADS/PNVS AUGMENTATION EQUIPMENT

TM 11-6625-3081-23-3, 1 February 1986, is changed as follows:

1. Remove and insert pages as indicated below. New or changed text material is indicated by a vertical bar in the margin. An illustration change is indicated by a miniature pointing hand.

Remove pages	Insert pages
A and B (Warning page)	----
-----	A through D
3-317 and 3-318	3-317 and 3-318
3-365 and 3-366	3-365 and 3-366
3-379/3-380	3-379/3-380
3-409 through 3-424	3-409 through 3-423/3-424
3-427 through 3-432	3-427 through 3-432
3-441 and 3-442	3-441 and 3-442
3-442.1 and 3-442.2	3-442.1 and 3-442.2
3-459 through 3-467	3-459 through 3-467/3-468
3-490 through 3-492	3-490 through 3-492
3-559 and 3-560	3-559 and 3-560
3-560.9 through 3-560.12	3-560.9 through 3-560.12
3-560.23 and 3-560.24	3-560.23 and 3-560.24
3-560.59 and 3-560.60	3-560.59 and 3-560.60
3-560.63 and 3-560.64	3-560.63 and 3-560.64
3-663 through 3-666	3-663 through 3-666
3-666.5 and 3-666.6	3-666.5 and 3-666.6

2. Retain this sheet in front of manual for reference purposes.

**By Order of the Secretary of the Army:**

**Official:**

**WILLIAM J. MEEHAN II**  
*Brigadier General, United States Army*  
*The Adjutant General*

**CARL E. VUONO**  
*General, United States Army*  
*Chief of Staff*

**DISTRIBUTION:**

To be distributed in accordance with DA Form 12-31A, Organizational and Direct Support Maintenance Manual for Electronic Equipment Test Facility TADS/PNVS Augmentation Equipment 13082700 and 13082808-29.





CHANGE }  
 NO. 9 }

HEADQUARTERS  
 DEPARTMENT OF THE ARMY  
 WASHINGTON, D.C., 28 February 1990

ORGANIZATIONAL AND DIRECT SUPPORT  
 MAINTENANCE MANUAL FOR ELECTRONIC EQUIPMENT  
 TEST FACILITY TADS/PNVS AUGMENTATION EQUIPMENT

TM 11-6625-3081-23-3, 1 February 1986, is changed as follows:

1. Remove and insert pages as indicated below. New or changed material is indicated by a vertical bar in the margin. An illustration change is indicated by a miniature pointing hand.

	Remove pages	Insert pages
Table of Contents	i / i i	i / i i
Chapter 3	3-317 and 3-318 3-339 and 3-340 3-371 and 3-372 3-375 and 3-376 3-411 through 3-414 3-435 through 3-440 3-442.3 and 3-442.4 3-560.1 and 3-560.2 3-560.35 and 3-560.36 3-563/3-564 3-564.1 through 3-566 3-665/3-666 3-666.1 and 3-666.2 3-667/3-668 3-668.1 through 3-670 3-671 and 3-672 Old 2028's Cover	3-317 and 3-318 3-339 and 3-340 3-371 and 3-372 3-375 and 3-376 3-411 through 3-414 3-435 through 3-440 3-442.3 and 3-442.4 3-560.1 and 3-560.2 3-560.35 and 3-560.36 3-563/3-564 - - - - 3-665 and 3-666 3-666.1 and 3-666.2 3-667/3-668 - - - - 3-671 and 3-672 New 2028's Cover

2. Retain this sheet in front of manual for reference purposes.

**By Order of the Secretary of the Army:**

**CARL E. VUONO**  
*General, United States Army*  
*Chief of Staff*

**Official:**

**WILLIAM J. MEEHAN II**  
*Brigadier General, United States Army*  
*The Adjutant General*

**DISTRIBUTION:**

To be distributed in accordance with DA Form 12-31A, Organizational and Direct Support Maintenance Manual for Electronic Equipment Test Facility TADS/PNVS Augmentation Equipment 13082700 and 13082808-29.

CHANGE }  
 NO. 8 }

HEADQUARTERS  
 DEPARTMENT OF THE ARMY  
 WASHINGTON, D.C., 20 February 1990

ORGANIZATIONAL AND DIRECT SUPPORT  
 MAINTENANCE MANUAL FOR ELECTRONIC EQUIPMENT  
 TEST FACILITY TADS/PNVS AUGMENTATION EQUIPMENT

TM 11-6625-3081-23-3, 1 February 1986 is changed as follows:

1. Remove old pages and insert new pages as indicated below. New or changed material is indicated by a vertical bar in the margin of the page. Added or revised illustrations are indicated by a vertical bar adjacent to the identification number or by a miniature pointing hand. Changes in wiring diagrams are indicated by shaded areas.

Remove pages	Insert pages
3-381 and 3-382	3-381 and 3-382
3-383 through 3-392	- - - -
3-409 through 3-420	3-409 through 3-420
3-491 and 3-492	3-491 and 3-492
3-492.1 and 3-492.2	3-492.1 and 3-492.2
3-493 through 3-500	- - - -
3-502	3-502
3-503 through 3-532	- - - -
3-533 through 3-536	3-533 through 3-536
3-537 through 3-556	- - - -

2. Retain this sheet in front of manual for reference purposes.

**By Order of the Secretary of the Army:**

**CARL E. VUONO**  
*General, United States Army*  
*Chief of Staff*

**Official:**

**WILLIAM J. MEEHAN II**  
*Brigadier General, United States Army*  
*The Adjutant General*

**DISTRIBUTION:**

To be distributed in accordance with DA Form 12-31A, Organizational and Direct Support Maintenance Manual for Electronic Equipment Test Facility TADS/PNVS Augmentation Equipment 13082700 and 13082808-29.



CHANGE

HEADQUARTERS  
DEPARTMENT OF THE ARMY  
Washington, DC, 15 May 1989

No. 7

**ORGANIZATIONAL AND DIRECT SUPPORT  
MAINTENANCE MANUAL FOR ELECTRONIC EQUIPMENT  
TEST FACILITY TADS/PNVS AUGMENTATION EQUIPMENT  
13082808-39, 13231600, 13231650 AND 13231800**

TM 11-6625-3081-23-3, 1 February 1986, is changed as follows:

1. Remove old pages and insert new pages as indicated below. New or changed material is indicated by a vertical bar in the margin of the page. An illustration change is indicated by a miniature pointing hand. Changes in wiring diagrams are indicated by shaded areas.

Remove pages	Insert pages
3-561 through 3-565/(3-566 blank) . . . . .	3-561 through 3-563/(3-564 blank)
3-627 and 3-628 . . . . .	3-627/(3-628 blank)
3-643 through 3-645/(3-646 blank). . . . .	3-643 /(3-644 blank)
3-651 /(3-652 blank) . . . . .	3-651 /(3-652 blank)

2. File this change sheet in the front of the publication for reference purposes.

**Distribution authorized to the Department of Defense and DOD contractors only for official use or for administration or operational purposes. This determination was made on 8 February 1989. Other requests for this document will be referred to Commander, US Army Communications-Electronics Command and Fort Monmouth, ATTN: AMSEL-LC-ME-P, Fort Monmouth, NJ 07703-5000.**

**DESTRUCTION NOTICE— Destroy by any method that will prevent disclosure of contents or reconstruction of the document.**

**By Order of the Secretary of the Army:**

**CARL E. VUONO**  
*General, United States Army*  
*Chief of Staff*

**Official:**

**WILLIAM J. MEEHAN II**  
*Brigadier General, United States Army*  
*The Adjutant General*

DISTRIBUTION:

To be distributed in accordance with DA Form 12-31A AVUM and AVIM requirements for AH-64A (APACHE).

CHANGE

No. 6

**HEADQUARTERS  
DEPARTMENT OF THE ARMY  
Washington, DC, 1 January 1989**

**ORGANIZATIONAL AND DIRECT SUPPORT  
MAINTENANCE MANUAL FOR ELECTRONIC EQUIPMENT  
TEST FACILITY TADS/PNVs AUGMENTATION EQUIPMENT  
13082808-39, 13231600, 13231650 AND 13231800**

TM 11-6625-3081-23-3, 1 February 1986, is changed as follows:

1. Remove old pages and insert new pages as indicated below. New or changed material is indicated by a vertical bar in the margin of the page. Added or revised illustrations are indicated by a vertical bar adjacent to the identification number or by a miniature pointing hand.

<i>Remove pages</i>	<i>Insert pages</i>
3-379/(3-380 blank) . . . . .	3-379/(3 -380 blank)
3-381 and 3-382 . . . . .	3-381 and 3-382
3-423 and 3-424 . . . . .	3-423/(3-424 blank)
3-443 through 3-454 . . . . .	3443/(3-444 blank)
3-563 /(3-564 blank) . . . . .	3-563/(3-564 blank)
3-666.7 and 3-666 .8 . . . . .	3-666.7 and 3-666.8

2. File this change sheet in the front of the publication for reference purposes,

**Distribution authorized to the Department of Defense and DOD contractors only for official use or for administration or operational purposes. This determination was made on 8 September 1988. Other requests for this document will be referred to Commander, US Army Communications-Electronics Command and Fort Monmouth, ATTN: AMSEL-LC-ME-P, Fort Monmouth, NJ 07703-5000.**

**DESTRUCTION NOTICE — Destroy by any method that will prevent disclosure of contents or reconstruction of the document.**



By Order of the Secretary of the Army:

CARL E. VUONO  
*General, United States Army*  
*Chief of Staff*

Official:

R.L. DILWORTH  
*Brigadier General, United States Army*  
*The Adjutant General*

DISTRIBUTION:

To be distributed in accordance with DA Form 12-31A AVUM and AVIM requirements for AH-64A.

CHANGE

No. 5

HEADQUARTERS  
DEPARTMENT OF THE ARMY  
Washington, DC, 1 August 1988

**ORGANIZATIONAL AND DIRECT SUPPORT  
MAINTENANCE MANUAL**

**ELECTRONIC EQUIPMENT TEST FACILITY  
TADS/PNVS AUGMENTATION EQUIPMENT  
13082808-39, 13231600, 13231650 AND 13231800**

TM 11-6625-3081-23-3, 1 February 1986, is changed as follows:

1. Title of manual is changed as shown above.
2. Remove old pages and insert new pages as indicated below. New or changed material is indicated by a vertical bar in the margin of the page. Added or revised illustrations are indicated by a vertical bar adjacent to the identification number.

*Remove pages*

*Insert pages*

3-560.7 through 3-560.14 . . . . .	3-560.7 through 3-560.14
3-560.17 through 3-560 .20. . . . .	3-560 .17 through 3-560.20
3-560.27 through 3-560.46 . . . . .	3-560 .27 through 3-560.46

3. File this change sheet in the front of the publication for reference purposes.

**Distribution authorized to the Department of Defense and DOD contractors only for official use or for administration or operational purposes. This determination was made on 15 March 1988. Other requests for this document will be referred to Commander, US Army Communications-Electronics Command and Fort Monmouth, ATTN: AMSEL-ME-P, Fort Monmouth, NJ 07703-5000.**

**DESTRUCTION NOTICE — Destroy by any method that will prevent disclosure of contents or reconstruction of the document.**

By order of the Secretary of the Army:

Official:

CARL E. VUONO  
*General, United States Army*  
*Chief of Staff*

R.L. DILWORTH  
*Brigadier General, United States Army*  
*The Adjutant General*

DISTRIBUTION:

To be distributed in accordance with DA Form 12-31A AVUM and AVIM requirements for AH-64A.

Change

HEADQUARTERS,  
DEPARTMENT OF THE ARMY  
Washington, DC, 1 July 1988

No. 4

ORGANIZATIONAL AND DIRECT SUPPORT  
MAINTENANCE MANUAL FOR ELECTRONIC EQUIPMENT  
TEST FACILITY TADS/PNVS AUGMENTATION EQUIPMENT

TM 11-6625-3081-23-3, 1 February 1986 is changed as follows:

1. Remove and insert pages as indicated below.

Remove pages

3-379/(3-380 blank)  
3-381 and 3-382  
3-423 and 3-424  
3-425 and 3-426  
3-453 and 3-454  
3-492.1 and 3-492.2  
3-493 thru 3-498  
3-499 and 3-502

Insert pages

3-379/(3-380 blank)  
3-381 and 3-382  
3-423 and 3-424  
3-425 and 3-426  
3-453 and 3-454  
3-492.1 and 3-492.2  
(3-501 blank)/3-502

2. New or changed material is indicated by a vertical bar in the margin. An illustration change is indicated by a miniature pointing hand. Changes in wiring diagrams are indicated by shaded areas.
3. Retain these pages in front of manual for reference purposes.

**Distribution authorized to the Department of Defense and DOD contractors only for official use or for administration or operational purposes. This determination was made on 8 March 1988. Other requests for this document will be referred to Commander, US Army Communications-Electronics Command and Fort Monmouth, ATTN: AMSEL-ME-P, Fort Monmouth, NJ 07703-5000.**

**DESTRUCTION NOTICE—Destroy by any method that will prevent disclosure of contents or reconstruction of the document.**

By Order of the Secretary of the Army:

official:

CARL E. VUONO  
*General, United States Army*  
*Chief of Staff*

R.L. DILWORTH  
*Brigadier General, United States Army*  
*The Adjutant General*

DISTRIBUTION:

To be distributed in accordance with DA Form 12-31A AVUM and AVIM requirements for EEC AH-64A.

Change)  
No. 3 )

HEADQUARTERS  
DEPARTMENT OF THE ARMY  
Washington, DC, 15 January 1988

ORGANIZATIONAL AND DIRECT SUPPORT  
MAINTENANCE MANUAL FOR ELECTRONIC EQUIPMENT  
TEST FACILITY TADS/PNVS AUGMENTATION EQUIPMENT

TM 11-6625-3081-23-3, 1 February 1986 is changed as follows:

1. Remove old pages and insert new pages as indicated below. New or changed material is indicated by a vertical bar in the margin of the page. Added or revised illustrations are indicated by a vertical bar adjacent to the identification number.

Remove pages

3-560.31 and 3-560.32  
3-560.37 and 3-560.38

Insert pages

3-560.31 and 3-560.32  
3-560.37 and 3-560.38

2. File this change sheet in front of the publication for reference purposes.

**Distribution authorized to the Department of Defense and DOD contractors only for official use or for administration or operational purposes. This determination was made on 8 September 1987. Other requests for this document will be referred to Commander, US Army Communications-Electronics Command and Fort Monmouth, ATTN: AMSEL-NE-P, Fort Monmouth, NJ 07703-5000.**

**DESTRUCTION NOTICE — Destroy by any method that will prevent disclosure of contents or reconstruction of the document.**

By Order of the Secretary of the Army:

Official:

CARL E. VUONO  
*General, United States Army*  
*Chief of Staff*

R.L. DILWORTH  
*Brigadier General, United States Army*  
*The Adjutant General*

DISTRIBUTION :

To be distributed in accordance with DA Form 12-31A literature requirements for EEC AH-64A.

Change  
No. 2

HEADQUARTERS,  
DEPARTMENT OF THE ARMY  
Washington, DC, 1 December 1987

ORGANIZATIONAL AND DIRECT SUPPORT  
MAINTENANCE MANUAL  
ELECTRONIC EQUIPMENT TEST FACILITY  
TADS/PNVS AUGMENTATION EQUIPMENT

TM 11-6625-3081-23-3, 1 February 1986 is changed as follows:

1. Remove old pages and insert new pages as indicated below. New or changed material is indicated by a vertical bar in the margin of the page. Added or revised illustrations are indicated by a pointing hand on the illustration pages. Changes in wiring diagrams are indicated by shaded areas.

<u>Remove pages</u>	<u>Insert pages</u>
3-309 through 3-314	3-309 through 3-314
3-317 through 3-324	3-317 through 3-324
3-327 and 3-328	3-327 and 3-328
3-331 and 3-332	3-331 and 3-332
3-339 through 3-342	3-339 through 3-342
3-353 and 3-354	3-353 and 3-354
3-357 through 3-360	3-357 through 3-360
3-363 through 3-412	3-363 through 3-412
3-423 through 3-426	3-423 through 3-424. 1/ (3-424. 2 blank)
None	3-25 and 3-426
3-431 through 3-458	3-431 through 3-442
3-442. 1 through 3-442. 4	3-442. 1 through 3-442. 4
None	3-443 through 3-492. 2
3-495 through 3-558	3-495 through 3-558
3-560. 1 through 3-560. 4	3-560. 1 through 3-560. 4
3-560. 7 through 3-560. 14	3-560. 6. 1/(3-560. 6. 2 blank) through 3-560. 14
3-561 through 3-568	3-560. 17 through 3-560. 66
None	3-561 through 3-567/ (3-568 blank)
3-573 through 3-614	3-573 through 3-614
3-617 through 3-622. 2	3-617 through 3-620
3-627 through 3-632	3-627 through 3-632
3-637 through 3-640	3-637 through 3-640

**Distribution authorized to the Department of Defense and DOD contractors only for official use or for administration or operational purposes. This determination was made on 14 August 1987. Other requests for this document will be referred to Commander, US Army Communications-Electronics Command and Fort Monmouth, ATTN: AMSEL-ME-P, Fort Monmouth, NJ 07703-5000.**

**DESTRUCTION NOTICE - Destroy by any method that will prevent disclosure of contents or reconstruction of this document.**



Remove pages

3-643 through 3-652

3-655 through 3-678

Insert pages

3-643 through 3-651/  
(3-652 blank)

3-55 through 3-679/  
(3-680 blank)

2. File this change sheet in front of the publication for reference purposes.

By Order of the Secretary of the Army:

Official:

**CARL E. VUONO**  
*General, United States Army*  
*Chief of Staff*

**R.L. DILWORTH**  
*Brigadier General, United States Army*  
*The Adjutant General*

DISTRIBUTION:

To be distributed in accordance with DA Form 12-31A literature requirements for EEC AH-64.

Change

HEADQUARTERS  
DEPARTMENT OF THE ARMY

No. 1

Washington, DC, 15 September 1987

ORGANIZATIONAL AND DIRECT SUPPORT MAINTENANCE MANUAL  
ELECTRONIC EQUIPMENT TEST FACILITY TADS/PNVS  
AUGMENTATION EQUIPMENT

TM 11-6625-3081-23-3, 1 February 1986, is changed as follows:

1. Remove old pages and inserts new pages as indicated below. New or changed material is indicated by a vertical bar in the margin of the page. Added or revised illustrations are indicated by a vertical bar adjacent to the identification number.

Remove Pages

3-427 and 3-428  
3-560.15 and 3-560.16

Insert Pages

3-427 and 3-428  
3-560.15 and 3-560.16

2. File this change sheet in front of the publication for reference purposes.

**Distribution authorized to the Department of Defense and DOD contractors only for official use or for administration or operational purposes. This determination was made on 15 June 1987. Other requests for this document will be referred to Commander, US Army Communications-Electronics Command and Fort Monmouth, ATTN: AMSEL-ME-P, Fort Monmouth, NJ 07703-5000.**

**DESTRUCTION NOTICE—Destroy by any method that will prevent disclosure of contents or reconstruction of the document.**

By Order of the Secretary of the Army:

Official:

CARL E. VUONO  
*General, United States Army*  
*Chief of Staff*

R.L. DILWORTH  
*Brigadier General, United States Army*  
*The Adjutant General*

DISTRIBUTION:

To be distributed in accordance with DA Form 12-31A literature requirements for EEC AH-64.

INSERT LATEST CHANGE PAGES. DESTROY SUPERSEDED PAGES.

# LIST OF EFFECTIVE PAGES

NOTE: The portion of the text affected by the changes is indicated by a vertical line in the outer margins of the page. Changes to illustrations are indicated by miniature pointing hands. Changes to wiring diagrams are indicated by shaded areas.

Dates of issue for original and change pages are:

Original.....	0....	01	February 1986
Change.....	1....	15	September 1987
Change.....	2....	01	December 1987
Change.....	3....	15	January 1988
Change.....	4....	01	July 1988
Change.....	5....	01	August 1988
Change.....	6....	01	January 1989
Change.....	7....	15	May 1989
Change.....	8....	20	February 1990
Change.....	9....	28	February 1990
Change.....	10....	06	June 1990
Change.....	11....	26	September 1990
Change.....	12....	09	March 1991
Change.....	13....	11	April 1991
Change.....	14....	07	August 1991
Change.....	15....	26	February 1993
Change.....	16....	30	July 1993
Change.....	17....	30	November 1993
Change.....	18....	31	July 1996
Change.....	19....	06	March 1997

TOTAL NUMBER OF PAGES IN THIS PUBLICATION IS 466, CONSISTING OF THE FOLLOWING:

Page No.	*Change No.	Page No.	*Change No.
Title . . . . .	5	3-327 . . . . .	2
a - b . . . . .	0	3-328 - 3-330 . . . . .	0
A-c . . . . .	19	3-331 . . . . .	13
D Blank . . . . .	17	3-332 - 3-335 . . . . .	0
i . . . . .	16	3-336 . . . . .	13
ii Blank . . . . .	0	3-337 - 3-338 . . . . .	0
3-309 . . . . .	0	3-339 . . . . .	13
3-310 . . . . .	2	3-340 . . . . .	0
3-311 . . . . .	0	3-341 . . . . .	2
3-312 . . . . .	13	3-342 - 3-353 . . . . .	0
3-313 - 3-314 . . . . .	2	3-354 . . . . .	2
3-315 - 3-316 . . . . .	0	3-355 . . . . .	13
3-317 . . . . .	9	3-356 - 3-357 . . . . .	0
3-318 . . . . .	10	3-358 - 3-359 . . . . .	2
3-319 . . . . .	0	3-360 - 3-363 . . . . .	0
3-320 - 3-324 . . . . .	2	3-364 . . . . .	2
3-325 - 3-326 . . . . .	0	3-365 . . . . .	0

\*Zero in this column indicates an original page.

INSERT LATEST CHANGE PAGES. DESTROY SUPERSEDED PAGES.

# LIST OF EFFECTIVE PAGES

NOTE: The portion of the text affected by the changes is indicated by a vertical line in the outer margins of the page. Changes to illustrations are indicated by miniature pointing hands. Changes to wiring diagrams are indicated by shaded areas.

Page No.	*Change No.	Page No.	*Change No.
3-366	10	3-501	4
3-367 - 3-369	2	3-502	17
3-370	0	3-503 - 3-532 Deleted	2
3-371	13	3-533	2
3-372	2	3-534 - 3-535	12
3-373	0	3-536	2
3-374	2	3-537 - 3-556 Deleted	0
3-375 - 3-376	9	3-557	2
3-377	2	3-558 - 3-559	0
3-378	0	3-560	10
3-379	19	3-560.1	17
3-380	2	3-560.2	17
3-381 - 3-383	12	3-560.3 - 3-560.4	2
3-384	12	3-560.5 - 3-560.6	0
3-385 - 3-392 Deleted	2	3-560.6.1	2
3-393 - 3-394	2	3-560.6.2	2
3-395 - 3-408 Deleted	2	3-560.7	2
3-409 - 3-411	16	3-560.8 - 3-560.14	18
3-412	10	3-560.14.1	18
3-413 - 4-416	8	3-560.14.2	18
3-417	8	3-560.15 - 3-560.18	12
3-418 - 3-423	16	3-560.19	5
3-424	6	3-560.20 - 3-560.21	2
3-424.1	2	3-560.22 - 3-560.23	12
3-424.2	0	3-560.24	10
3-425	17	3-560.25 - 3-560.26	2
3-426	17	3-560.27 - 3-560.28	12
3-427 - 3-458 deleted	17	3-560.29 - 3-560.46	16
3-459	0	3-560.47	2
3-460 - 3-462	12	3-560.48 - 3-560.51	12
3-463	10	3-560.52 - 3-560.55	2
3-464	2	3-560.56 - 3-560.57	12
3-465 - 3-466	12	3-560.58	2
3-467	10	3-560.59 - 3-560.61	19
3-468 - 3-489 Deleted	2	3-560.62	19
3-490	0	3-561 - 3-562	17
3-491	8	3-563	19
3-492	10	3-564	2
3-492.1 - 3-492.2	8	3-564.1 - 3-566 Deleted	7
3-493 - 3-500 Deleted	4	3-567	2

**LIST OF EFFECTIVE PAGES**

NOTE: The portion of text affected by the changes is indicated by a vertical line in the outer margin of the page. Changes to illustrations are indicated by miniature pointing hands. Charges to wiring diagrams are indicated by shaded areas.

Page No.	*Change No.	Page No.	*Change No.
3-564 Blank	2	3-626.1	0
3-564.1 - 3-566 Deleted	7	3-626.2	17
3-567	2	3-626.3 - 3-626.5	2
3-568 Blank	2	3-626.6 Blank	0
3-569 - 3-570	0	3-627	7
3-571 - 3-572 Deleted	0	3-628 Blank	7
3-573	2	3-629	2
3-574 Blank	2	3-630	17
3-574.1 - 3-574.2 Deleted	2	3-631 - 3-646 Deleted	17
3-575	2	3-647	0
3-576 - 3-577 Deleted	2	3-648	17
3-578	17	3-648.1 - 3-650 Deleted	17
3-579	13	3-651	7
3-580 Blank	13	3-652 Blank	2
3-581 - 3-592 Deleted	2	3-653	17
3-593	2	3-654	0
3-594 Blank	2	3-655	2
3-595 - 3-598 Deleted	2	3-656 - 3-661 Deleted	2
3-599	2	3-662	0
3-600 - 3-601 Deleted	2	3-663	10
3-602 - 3-603	0	3-664	2
3-604 - 3-605	2	3-665	17
3-606 Blank	2	03-666 Blank	17
3-606.1 Blank	17	3-666.1	9
3-606.2	17	3-666.2	2
3-607 - 3-608 Deleted	2	3-666.3	14
3-609	2	3-666.4	2
3-610 Blank	2	3-666.5 - 3.666.6	12
3-611	17	3-666.7	2
3-612 Blank	2	3-666.8	6
3-613 - 3-616 Deleted	17	3-667	16
3-617 Blank	17	3-668 Blank	2
3-618	17	3-668.1 - 3-670 Deleted	9
3-619	0	3-671	9
3-620	2	3-672 - 3-677	16
3-620.1 - 3-622.2 Deleted	2	3-678 - 3-679	2
3-623 - 3-626	0	3-680 Blank	2

\*Zero in this column indicates an original page.



ORGANIZATIONAL AND DIRECT SUPPORT  
 MAINTENANCE MANUAL  
 FOR  
 ELECTRONIC EQUIPMENT TEST FACILITY  
 TADS/PNVS AUGMENTATION EQUIPMENT

REPORTING ERRORS AND RECOMMENDING IMPROVEMENTS

You can help improve this manual. If you find any mistakes or if you know of a way to improve the procedures, please let us know. Mail your letter, DA Form 2028 (Recommended Changes to Publications and Blank Forms), or DA Form 2028-2 located in the back of this manual direct to: Commander, U.S. Army Aviation and Troop Command, ATTN: AMSAT-I-MP, 4300 Goodfellow Blvd, St. Louis, MO 63120-1798. A reply will be furnished to you.

	Page
CHAPTER 3. WIRING DATA (cont)	
Section VIII. <span style="border: 1px solid black; padding: 2px;">Test Program Sets Wiring Data</span> . . . . .	3-309





Section VIII. TEST PROGRAM SETS WIRING DATA

Subject	Para	Page
Major Test Adapter . . . . .	3-31	3-309
TPS Cable Assemblies . . . . .	3-32	3-379
Self-Test Connectors . . . . .	3-33	3-561
Test Fixtures . . . . .	3-34	3-667

---

3-31. MAJOR TEST ADAPTER 3-31

---

The data contained in this paragraph provides the wire list for the internal wiring of the major test adapter.



The wire list contains a series of numbers that relate to wire wrap pins of the motherboard. This data is provided in column-row format and runs from 1-1 thru 35-110. The numbers across the bottom of the motherboard indicate the column. The numbers down the side indicate the row.

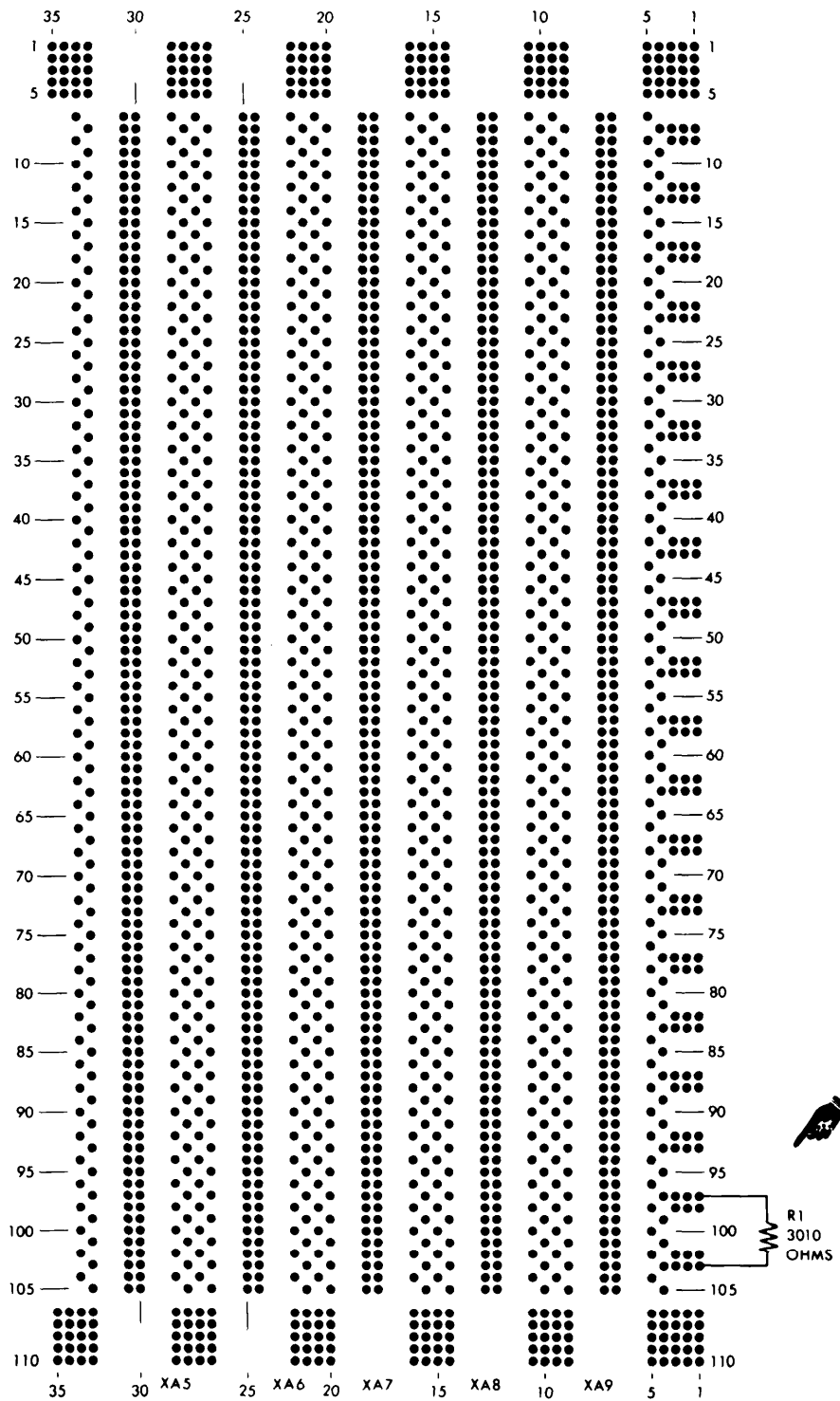

EL9LQ-1000-83B

3-31. MAJOR TEST ADAPTER (cont)

3-31

FROM	TO	WIRE ID	WIRE SIZE	FROM	TO	WIRE ID	WIRE SIZE
J1-A1	P1-S21	1329	26	J1-H5	16-85	1309	26
J1-A2	P1-S23	1331	26	J1-H6	17-86	1311	26
J1-A3	P1-S25	1333	26	J1-J1	16-87	1313	26
J1-A4	P1-R15	1335	26	J1-J2	17-88	1316	26
J1-A5	P1-R17	1337	26	J1-J3	16-89	1318	26
J1-A6	P1-R19	1339	26	J1-J4	17-90	1320	26
J1-B1	P1-R22	1341	26	J1-J5	16-91	1322	26
J1-B2	P1-R24	1343	26	J1-J6	17-92	1324	26
J1-B3	P1-R26	1346	26	J1-K1	16-75	1326	26
J1-B4	P1-Q14	1348	26	J1-K2	11-10	1518	26
J1-B5	P1-Q16	1350	26	J1-K3	10-11	1520	26
J1-B6	P1-Q18	1352	26	J1-K4	11-12	1522	26
J1-C1	P1-Q21	1354	26	J1-K5	10-13	1524	26
J1-C2	P1-Q23	1356	26	J1-K6	11-14	1526	26
J1-C3	P1-Q25	1358	26	J1-L1	10-15	1528	26
J1-C4	33-62	1815	26	J1-L2	11-16	1530	26
J1-C5	32-63	1817	26	J1-L3	10-17	1532	26
J1-C6	33-64	1819	26	J1-L4	11-18	1535	26
J1-D1	33-94	1821	26	J1-L5	10-19	1537	26
J1-D2	32-95	1823	26	J1-L6	11-20	1539	26
J1-D3	33-96	1825	26	J1-M1	10-21	1541	26
J1-D4	32-97	1827	26	J1-M2	11-22	1543	26
J1-D5	33-98	1829	26	J1-M3	10-23	1545	26
J1-D6	32-99	1832	26	J1-M4	11-24	1547	26
J1-E1	33-102	1834	26	J1-M5	10-25	1550	26
J1-E2	32-103	1836	26	J1-M6	11-26	1552	26
J1-E3	33-104	1838	26	J1-N1	10-27	1554	26
J1-E4	32-105	1840	26	J1-N2	11-28	1556	26
J1-E5	29-72	1842	26	J1-N3	10-29	1558	26
J1-E6	28-73	1844	26	J1-N4	11-30	1560	26
J1-F1	29-74	1847	26	J1-N5	10-31	1563	26
J1-F2	28-75	1849	26	J1-N6	11-32	1565	26
J1-F3	29-76	1851	26	J1-P1	10-33	1567	26
J1-F4	28-77	1853	26	J1-P2	11-34	1569	26
J1-F5	29-78	1855	26	J1-P3	10-35	1571	26
J1-F6	28-79	1857	26	J1-P4	11-36	1573	26
J1-G1	29-80	1859	26	J1-P5	10-37	1576	26
J1-G2	33-56	1862	26	J1-P6	11-38	1578	26
J1-G3	32-57	1864	26	J1-R1	10-39	1580	26
J1-G4	33-58	1866	26	J1-R2	11-40	1582	26
J1-G5	32-59	1868	26	J1-R3	10-41	1584	26
J1-G6	16-47	1303	26	J1-R4	11-42	1586	26
J1-H1	SPL150	1903	26	J1-R5	10-43	1589	26
J1-H2	17-74	1305	26	J1-R6	11-44	1591	26
J1-H3	SPL149	1904	26	J1-S1	10-45	1593	26
J1-H4	17-84	1307	26	J1-S2	11-46	1595	26

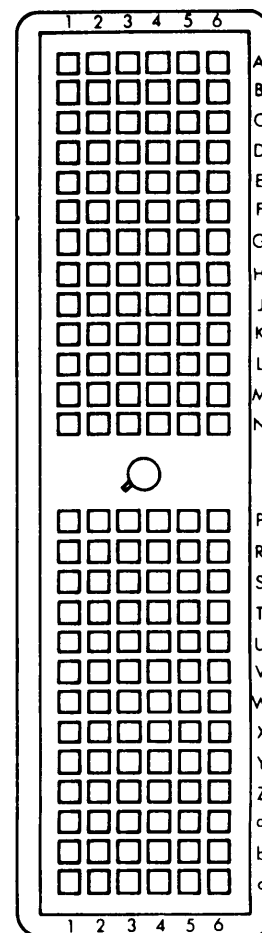

EL9LQ-1000-82 A

J1 - DL1-156RW4

3-31. MAJOR TEST ADAPTER (cont)

FROM	TO	WIRE ID	WIRE SIZE	FROM	TO	WIRE ID	WIRE SIZE
J1-S3	10-47	1597	26	J1-a1	4-25	1738	26
J1-S4	11-48	1599	26	J1-a2	5-6	1740	26
J1-S5	10-49	1602	26	J1-a3	4-7	1742	26
J1-S6	11-50	1604	26	J1-a4	5-8	1745	26
J1-T1	10-51	1606	26	J1-a5	4-9	1747	26
J1-T2	11-52	1608	26	J1-a6	5-10	1749	26
J1-T3	10-53	1610	26	J1-b1	5-34	1751	26
J1-T4	11-54	1612	26	J1-b2	4-35	1753	26
J1-T5	10-55	1614	26	J1-b3	5-36	1755	26
J1-T6	11-56	1617	26	J1-b4	4-37	1758	26
J1-U1	10-57	1619	26	J1-b5	5-38	1760	26
J1-U2	11-58	1621	26	J1-b6	4-39	1762	26
J1-U3	10-59	1623	26	J1-c1	5-40	1764	26
J1-U4	11-60	1625	26	J1-c2	4-41	1766	26
J1-U5	10-61	1627	26	J1-c3	5-84	1768	26
J1-U6	11-62	1629	26	J1-c4	4-85	1770	26
J1-V1	10-63	1632	26	J2-A1	J4-E1	403	26
J1-V2	11-64	1634	26	J2-A2	P1-P15	1361	26
J1-V3	10-65	1636	26	J2-A3	J4-E2	405	26
J1-V4	11-66	1638	26	J2-A4	P1-P17	1363	26
J1-V5	10-67	1640	26	J2-A5	J4-E3	407	26
J1-V6	11-68	1642	26	J2-A6	P1-P19	1365	26
J1-W1	8-45	1645	26	J2-B1	J4-E4	409	26
J1-W2	9-46	1647	26	J2-B2	P1-P22	1367	26
J1-W3	8-47	1649	26	J2-B3	J4-E5	411	26
J1-W4	9-48	1651	26	J2-B4	P1-P24	1369	26
J1-W5	8-49	1653	26	J2-B5	J4-E6	413	26
J1-W6	9-50	1655	26	J2-B6	P1-P26	1371	26
J1-X1	8-51	1657	26	J2-C1	J4-F1	415	26
J1-X2	9-52	1660	26	J2-C2	P1-N14	1373	26
J1-X3	8-53	1662	26	J2-C3	J4-F2	417	26
J1-X4	9-54	1664	26	J2-C4	P1-N16	1375	26
J1-X5	8-55	1666	26	J2-C5	J4-F3	421	26
J1-X6	5-12	1668	26	J2-C6	P1-N18	1378	26
J1-Y1	4-13	1670	26	J2-D1	J4-F4	423	26
J1-Y2	5-14	1672	26	J2-D2	P1-Y26	347	26
J1-Y3	4-15	1675	26	J2-D3	J4-F5	425	26
J1-Y4	5-16	1677	26	J2-D4	P1-N21	1380	26
J1-Y5	4-17	1679	26	J2-D5	J4-F6	427	26
J1-Y6	5-18	1681	26	J2-D6	P1-N23	1382	26
J1-Z1	4-19	1683	26	J2-E1	J4-G1	429	26
J1-Z2	5-20	1685	26	J2-E2	STP328	703	26
J1-Z3	8-21	1730	26	J2-E2	SPL56	494	26
J1-Z4	9-22	1732	26	J2-E3	J4-G2	431	26
J1-Z5	8-23	1734	26	J2-E4	SPL37	307	26
J1-Z6	9-24	1736	26	J2-E4	SPL43	402	26

3-31. MAJOR TEST ADAPTER (cont)

FROM	TO	WIRE ID	WIRE SIZE	FROM	TO	WIRE ID	WIRE SIZE
J2-E5	J4-G3	433	26	J2-N2	20-23	508	26
J2-E6	SPL60	530	26	J2-N3	21-24	510	26
J2-E6	SPL31	253	26	J2-N4	20-25	514	26
J2-F1	J4-G4	435	26	J2-N5	21-26	516	26
J2-F2	SPL68	592	26	J2-N6	20-27	518	26
J2-F2	SPL64	564	26	J2-P1	27-26	915	26
J2-F3	P1-Y24	345	26	J2-P2	27-28	915	26
J2-F5	P1-N25	1384	26	J2-P3	27-30	917	26
J2-F6	P1-M15	1386	26	J2-P4	27-32	917	26
J2-G1	1-97	437	26	J2-P5	33-54	520	26
J2-G1	J4-R1	701	26	J2-P6	32-55	522	26
J2-G5	P1-M17	1388	26	J2-R1	33-48	524	26
J2-G6	P1-M19	1390	26	J2-R2	32-49	526	26
J2-H1	P1-Z25	397	26	J2-R3	33-50	528	26
J2-H2	17-56	442	26	J2-R4	32-51	532	26
J2-H3	16-57	444	26	J2-R5	33-52	534	26
J2-H4	17-58	446	26	J2-R6	32-53	536	26
J2-H5	16-59	448	26	J2-S1	29-52	538	26
J2-H6	17-60	450	26	J2-S2	28-53	540	26
J2-J1	16-49	452	26	J2-S3	29-54	542	26
J2-J2	17-50	454	26	J2-S4	28-55	544	26
J2-J3	16-51	456	26	J2-S5	33-46	546	26
J2-J4	17-52	460	26	J2-S6	32-47	550	26
J2-J5	16-53	462	26	J2-T1	29-46	552	24
J2-J6	17-54	464	26	J2-T2	28-47	554	24
J2-K1	21-40	466	26	J2-T3	29-48	556	24
J2-K2	20-41	468	26	J2-T4	28-49	558	24
J2-K3	21-42	470	26	J2-T5	29-50	560	26
J2-K4	20-43	472	26	J2-T6	28-51	562	26
J2-K5	21-44	474	26	J2-U1	P1-Q1	167	26
J2-K6	17-48	478	26	J2-U2	P1-Q3	169	26
J2-L1	21-34	480	26	J2-U3	P1-Q5	171	26
J2-L2	20-35	482	26	J2-U4	P1-Q8	173	26
J2-L3	21-36	484	26	J2-U5	P1-Q10	175	26
J2-L4	20-37	486	26	J2-U6	P1-Q12	177	26
J2-L5	21-38	488	26	J2-V1	P1-R2	181	26
J2-L6	20-39	490	26	J2-V2	P1-R4	183	26
J2-M1	21-28	492	26	J2-V3	P1-R6	185	26
J2-M2	20-29	496	26	J2-V4	P1-R9	187	26
J2-M3	21-30	498	26	J2-V5	P1-R11	189	26
J2-M4	20-31	500	26	J2-V6	P1-R13	191	26
J2-M5	21-32	502	26	J2-W1	P1-S1	193	26
J2-M6	20-33	504	26	J2-W2	P1-S3	195	26
J2-N1	21-22	506	26	J2-W3	P1-S5	199	26

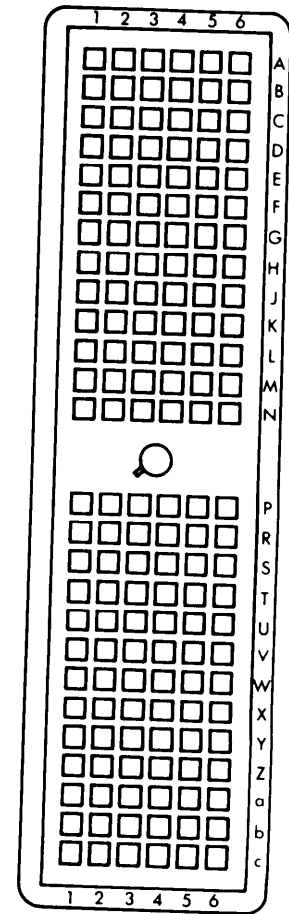

EL9LQ-1000-82 A

J2 - DL1-156RW 4

3-31. MAJOR TEST ADAPTER (cont)

FROM	TO	WIRE ID	WIRE SIZE	FROM	TO	WIRE ID	WIRE SIZE
J2-W4	P1-S8	201	26	J3-C5	J4-B3	642	26
J2-W5	P1-S10	203	26	J3-C6	P1-Z5	353	26
J2-W6	P1-S12	205	26	J3-D1	J4-B4	644	26
J2-X1	P1-U2	211	26	J3-D2	16-63	600	26
J2-X2	P1-U4	213	26	J3-D3	J4-B5	646	26
J2-X3	P1-U6	217	26	J3-D4	P1-Y9	328	26
J2-X4	P1-U9	219	26	J3-D5	J4-B6	648	26
J2-X5	P1-U11	221	26	J3-D6	P1-Z8	355	26
J2-X6	P1-U13	223	26	J3-E1	J4-C1	650	26
J2-Y1	P1-V1	240	26	J3-E2	17-64	602	26
J2-Y2	P1-V3	242	26	J3-E3	J4-C2	652	26
J2-Y3	P1-V5	244	26	J3-E4	P1-Y11	330	26
J2-Y4	P1-V8	246	26	J3-E5	J4-C3	654	26
J2-Y5	P1-V10	248	26	J3-E6	P1-Z10	357	26
J2-Y6	P1-V12	250	26	J3-F1	J4-C4	656	26
J2-Z1	P1-W2	266	26	J3-F2	SPL70	610	26
J2-Z2	P1-W4	268	26	J3-F2	SPL77	659	26
J2-Z3	P1-W6	272	26	J3-F3	SPL45	362	26
J2-Z4	P1-W9	274	26	J3-F4	P1-Y13	332	26
J2-Z5	P1-W11	276	26	J3-F6	P1-Z12	359	26
J2-Z6	P1-W13	278	26	J3-G1	P1-H2	73	26
J2-a1	P1-X1	293	26	J3-G2	P1-H4	75	26
J2-a2	P1-X3	295	26	J3-G3	P1-H6	77	26
J2-a3	P1-X5	297	26	J3-G4	P1-H9	79	26
J2-a4	P1-X8	299	26	J3-G5	P1-H11	81	26
J2-a5	P1-X10	301	26	J3-G6	P1-H13	83	26
J2-a6	P1-X12	303	26	J3-H1	P1-J1	85	26
J2-b1	15-100	566	26	J3-H2	P1-J3	87	26
J2-b2	14-101	568	26	J3-H3	P1-J5	90	26
J2-b3	15-102	570	26	J3-H4	P1-J8	92	26
J2-b4	14-103	572	26	J3-H5	P1-J10	94	26
J2-b5	15-104	574	26	J3-H6	P1-J12	96	26
J2-b6	14-105	576	26	J3-J1	P1-K2	98	26
J2-c1	11-100	578	26	J3-J2	P1-K4	100	26
J2-c2	10-101	580	26	J3-J3	P1-K6	102	26
J2-c3	11-102	584	26	J3-J4	P1-K9	104	26
J2-c4	10-103	586	26	J3-J5	P1-K11	108	26
J2-c5	11-104	588	26	J3-J6	P1-K13	110	26
J2-c6	10-105	590	26	J3-K1	P1-L1	112	26
J3-A2	16-55	594	26	J3-K2	P1-L3	114	26
J3-A4	P1-Y2	320	26	J3-K3	P1-L5	116	26
J3-A6	P1-Z1	349	26	J3-K4	P1-L8	118	26
J3-B2	16-61	596	26	J3-K5	P1-L10	120	26
J3-B4	P1-Y4	322	26	J3-K6	P1-L12	122	26
J3-B6	P1-Z3	351	26	J3-L1	P1-M2	126	26
J3-C2	17-62	598	26	J3-L2	P1-M4	128	26
J3-C4	P1-Y6	326	26	J3-L3	P1-M6	130	26

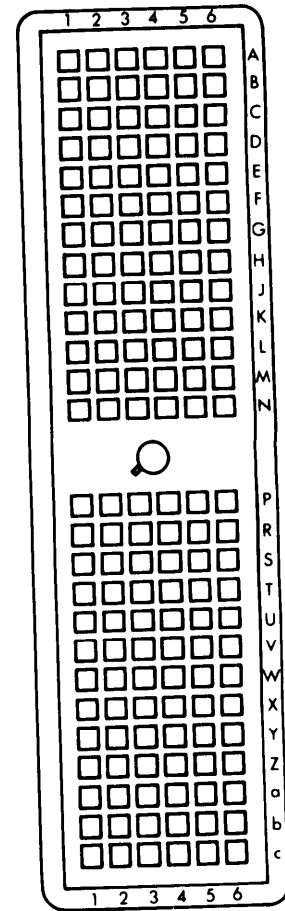

EL9LQ-1000-82A

J3 - DL1-156RW4

## 3-31. MAJOR TEST ADAPTER (cont)

3-31

FROM	TO	WIRE ID	WIRE SIZE	FROM	TO	WIRE ID	WIRE SIZE
J3-L4	P1-M9	132	26	J3-V3	4-49	993	26
J3-L5	P1-M11	134	26	J3-V4	5-48	991	26
J3-L6	P1-M13	136	26	J3-V5	4-47	989	26
J3-M1	P1-N1	138	26	J3-V6	5-46	987	26
J3-M2	P1-N3	140	26	J3-W1	P1-U19	229	26
J3-M3	P1-N5	144	26	J3-W2	P1-U22	231	26
J3-M4	P1-N8	146	26	J3-W3	P1-U24	236	26
J3-M5	P1-N10	148	26	J3-W4	P1-U26	238	26
J3-M6	P1-N12	150	26	J3-W5	P1-S14	207	26
J3-N1	P1-P2	152	26	J3-W6	P1-S16	209	26
J3-N2	P1-P4	154	26	J3-X1	P1-V18	258	26
J3-N3	P1-P6	156	26	J3-X2	P1-V21	260	26
J3-N4	P1-P9	158	26	J3-X3	P1-V23	262	26
J3-N5	P1-P11	162	26	J3-X4	P1-V25	264	26
J3-N6	P1-P13	164	26	J3-X5	P1-U15	225	26
J3-P1	29-24	1871	26	J3-X6	P1-U17	227	26
J3-P2	28-25	1873	26	J3-Y1	P1-W19	284	26
J3-P3	33-60	1875	26	J3-Y2	P1-W22	286	26
J3-P4	32-61	1877	26	J3-Y3	P1-W24	289	26
J3-P5	32-67	1879	26	J3-Y4	P1-W26	291	26
J3-P6	5-42	979	26	J3-Y5	P1-V14	254	26
J3-R1	33-68	1881	26	J3-Y6	P1-V16	256	26
J3-R2	32-69	1883	26	J3-Z1	P1-X18	312	26
J3-R3	33-86	1885	26	J3-Z2	P1-X21	314	26
J3-R4	33-88	1888	26	J3-Z3	P1-X23	316	26
J3-R5	33-90	1890	26	J3-Z4	P1-X25	318	26
J3-R6	4-43	981	26	J3-Z5	P1-W15	280	26
J3-S1	33-92	1892	26	J3-Z6	P1-W17	282	26
J3-S2	29-102	1894	26	J3-a1	P1-X14	308	26
J3-S3	28-103	1896	26	J3-a2	P1-X16	310	26
J3-S4	29-104	1898	26	J3-a3	J4-W2	736	26
J3-S5	J4-R3	604	26	J3-a3	J4-W2	738	26
J3-S6	5-44	983	26	J3-a4	J4-W3	747	26
J3-T1	J4-R4	606	26	J3-a4	J4-W3	749	26
J3-T2	28-105	1900	26	J3-a5	J4-W4	751	26
J3-T3	J4-R5	608	26	J3-a5	J4-W4	753	26
J3-T5	J4-R6	612	26	J3-a6	J4-W5	755	26
J3-T6	4-45	985	26	J3-a6	J4-W5	757	26
J3-U1	J4-S1	614	26	J3-b1	J4-Y1	759	26
J3-U2	SPL9	89	26	J3-b1	J4-Y1	761	26
J3-U3	J4-S2	616	26	J3-b2	J4-Y2	764	26
J3-U4	SPL73	622	26	J3-b2	J4-Y2	766	26
J3-U5	J4-S3	618	26	J3-b3	J4-Y3	768	26
J3-U6	SPL107	995	26	J3-b3	J4-Y3	770	26
J3-V1	J4-S4	620	26	J3-b4	J4-W1	732	26
J3-V2	SPL30	271	26	J3-b4	J4-W1	734	26



FROM	TO	WIRE ID	WIRE SIZE	FROM	TO	WIRE ID	WIRE SIZE
J3-b5	J4-U5	732	26	J4-E3	J2-A5	407	26
J3-b5	J4-U5	734	26	J4-E4	J2-B1	409	26
J3-b6	J4-U6	736	26	J4-E5	J2-B3	411	26
J3-b6	J4-U6	738	26	J4-E6	J2-B5	413	26
J3-c1	J4-X1	759	26	J4-F1	J2-C1	415	26
J3-c1	J4-X1	761	26	J4-F2	J2-C3	417	26
J3-c2	J4-X2	764	26	J4-F3	J2-C5	421	26
J3-c2	J4-X2	766	26	J4-F4	J2-D1	423	26
J3-c3	J4-X3	768	26	J4-F5	J2-D3	425	26
J3-c3	J4-X3	770	26	J4-F6	J2-D5	427	26
J3-c4	J4-V5	747	26	J4-G1	J2-E1	429	26
J3-c4	J4-V5	749	26	J4-G2	J2-E3	431	26
J3-c5	J4-V6	751	26	J4-G3	J2-E5	433	26
J3-c5	J4-V6	753	26	J4-G4	J2-F1	435	26
J3-c6	J4-W6	755	26	J4-G5	20-53	660	26
J3-c6	J4-W6	757	26	J4-G6	21-52	660	26
J4-A1	16-65	624	26	J4-H1	20-59	663	26
J4-A2	17-66	626	26	J4-H2	21-58	663	26
J4-A3	16-67	628	26	J4-H3	20-57	666	26
J4-A4	17-68	630	26	J4-H4	21-56	666	26
J4-A5	16-69	632	26	J4-H5	20-55	669	26
J4-A6	20-69	634	26	J4-H6	21-54	669	26
J4-B1	21-68	636	26	J4-J3	20-63	672	26
J4-B2	20-67	638	26	J4-J4	21-62	672	26
J4-B3	J3-C5	642	26	J4-J5	20-61	675	26
J4-B4	J3-D1	644	26	J4-J6	21-60	675	26
J4-B5	J3-D3	646	26	J4-L1	22-55	680	26
J4-B6	J3-D5	648	26	J4-L2	23-56	680	26
J4-C1	J3-E1	650	26	J4-L3	SW2-COM	1247	26
J4-C2	J3-E3	652	26	J4-L4	SW2-NO	1248	26
J4-C3	J3-E5	654	26	J4-L4	SW1-3	1249	26
J4-C4	J3-F1	656	26	J4-M1	21-46	683	26
J4-C5	SPL 74	640	26	J4-M2	20-47	683	26
J4-C5	SPL 86	772	26	J4-M3	21-48	686	26
J4-C6	SPL 76	658	26	J4-M4	20-49	686	26
J4-C6	SPL 87	789	26	J4-M5	21-50	689	26
J4-D1	SPL 82	730	26	J4-M6	20-51	689	26
J4-D1	SPL 85	763	26	J4-N1	26-57	692	26
J4-D2	SPL 84	746	26	J4-N2	27-60	692	26
J4-D2	SPL 51	441	26	J4-N3	27-56	695	26
J4-D3	SPL 72	623	26	J4-N4	26-59	695	26
J4-D4	SPL 80	704	26	J4-N5	26-55	698	26
J4-D5	SPL 42	401	26	J4-N6	27-58	698	26
J4-D6	SPL 78	678	26	J4-P1	P1-Z14	363	26
J4-E1	J2-A1	403	26	J4-P2	P1-Z16	369	26
J4-E2	J2-A3	405	26	J4-P3	P1-Z18	375	26

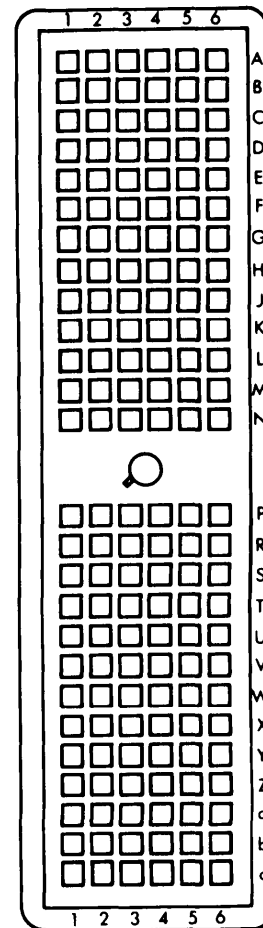

EL9LQ-1000-82 A

J4 - DL1-156RW4

## 3-31. MAJOR TEST ADAPTER (cont)

3-31

FROM	TO	WIRE ID	WIRE SIZE	FROM	TO	WIRE ID	WIRE SIZE
J4-P4	P1-Z21	381	26	J4-W3	J3-a4	749	26
J4-P5	P1-Z23	388	26	J4-W4	J3-a5	751	26
J4-P6	P1-Z25	394	26	J4-W4	J3-a5	753	26
J4-R1	P1-Y15	334	26	J4-W5	J3-a6	755	26
J4-R1	J2-G1	701	26	J4-W5	J3-a6	757	26
J4-R2	P1-Y17	337	26	J4-W6	J3-c6	755	26
J4-R3	J3-S5	604	26	J4-W6	J3-c6	757	26
J4-R4	J3-T1	606	26	J4-X1	J3-c1	759	26
J4-R5	J3-T3	608	26	J4-X1	J3-c1	761	26
J4-R6	J3-T5	612	26	J4-X2	J3-c2	764	26
J4-S1	J3-U1	614	26	J4-X2	J3-c2	766	26
J4-S2	J3-U3	616	26	J4-X3	J3-c3	768	26
J4-S3	J3-U5	618	26	J4-X3	J3-c3	770	26
J4-S4	J3-V1	620	26	J4-X4	SW4-NO	1257	26
J4-S5	20-73	706	26	J4-X5	32-101	1252	26
J4-S6	21-74	709	26	J4-X6	J4-b3	1251	26
J4-T1	20-77	712	26	J4-Y1	J3-b1	759	26
J4-T2	21-78	712	26	J4-Y1	J3-b1	761	26
J4-T3	20-83	715	26	J4-Y2	J3-b2	764	26
J4-T4	21-84	715	26	J4-Y2	J3-b2	766	26
J4-T5	20-75	706	26	J4-Y3	J3-b3	768	26
J4-T6	21-76	709	26	J4-Y3	J3-b3	770	26
J4-U1	20-79	718	26	J4-Y6	33-100	1259	26
J4-U1	20-79	721	26	J4-Z2	17-102	773	26
J4-U2	21-80	724	26	J4-Z3	16-103	773	26
J4-U2	21-80	727	26	J4-Z4	17-104	775	26
J4-U3	20-81	718	26	J4-Z5	21-102	777	26
J4-U3	20-81	721	26	J4-Z6	20-103	777	26
J4-U4	21-82	724	26	J4-a3	16-105	775	26
J4-U4	21-82	727	26	J4-a5	21-104	779	26
J4-U5	J3-b5	732	26	J4-a6	20-105	779	26
J4-U5	J3-b5	734	26	J4-b1	14-108	781	26
J4-U6	J3-b6	736	26	J4-b2	14-109	784	26
J4-U6	J3-b6	738	26	J4-b3	14-107	781	26
J4-V1	32-89	740	26	J4-b3	SW1-4	1250	26
J4-V2	32-91	740	26	J4-b3	J4-X6	1251	26
J4-V3	32-85	743	26	J4-b4	14-110	784	26
J4-V4	32-87	743	26	J4-b5	SPL89	795	26
J4-V5	J3-c4	747	26	J4-c1	21-92	787	26
J4-V5	J3-c4	749	26	J4-c2	20-93	787	26
J4-V6	J3-c5	751	26	J4-c3	20-89	791	26
J4-V6	J3-c5	753	26	J4-c4	21-94	793	26
J4-W1	J3-b4	732	26	J4-c5	21-98	791	26
J4-W1	J3-b4	734	26	J4-c6	20-99	793	26
J4-W2	J3-a3	736	26	J5	33-6	796	COAX
J4-W2	J3-a3	738	26	J5	STP373	796	COAX
J4-W3	J3-a4	747	26				

FROM	TO	WIRE ID	WIRE SIZE	FROM	TO	WIRE ID	WIRE SIZE	FROM	TO	WIRE ID	WIRE SIZE
J6	STP374	797	COAX	P1-A3	SPL2	3	26	P1-B14	15-18	1498	26
J6	29-8	797	COAX	P1-A4	20-45	3	26	P1-B15	STP576	1498	26
J7	33-8	798	COAX	P1-A14	STP582	1511	26	P1-B16	14-19	1501	26
J7	STP375	798	COAX	P1-A15	15-24	1511	26	P1-B17	STP577	1501	26
J8	29-10	799	COAX	P1-A16	STP583	1513	26	P1-B18	15-20	1503	26
J8	STP376	799	COAX	P1-A17	14-25	1513	26	P1-B19	STP578	1503	26
J9	33-10	800	COAX	P1-B1	16-39	5	26	P1-B21	14-21	1505	26
J9	STP377	800	COAX	P1-B2	SPL2	5	26	P1-B22	STP579	1505	26
J10	29-12	801	COAX	P1-B3	17-40	7	26	P1-B23	15-22	1507	26
J10	STP378	801	COAX	P1-B4	SPL2	7	26	P1-B24	STP580	1507	26
J11	33-12	802	COAX	P1-B5	16-41	9	26	P1-B25	14-23	1509	26
J11	STP379	802	COAX	P1-B6	SPL2	9	26	P1-B26	STP581	1509	26
J12	29-14	803	COAX	P1-B8	17-42	11	26	P1-C1	SPL3	19	26
J12	STP380	803	COAX	P1-B9	SPL2	11	26	P1-C2	16-33	19	26
J13-HI	33-14	1300	26	P1-B10	16-43	13	26	P1-C3	SPL3	21	26
J13-LO	33-16	1301	26	P1-B11	SPL2	13	26	P1-C4	17-34	21	26
J13-GND	33-18	1302	26	P1-B12	17-44	15	26	P1-C5	SPL3	23	26
P1-A1	SPL2	1	26	P1-B13	SPL2	15	26	P1-C6	16-35	23	26
P1-A2	16-45	1	26	P1-B13	SPL1	17	26	P1-C8	SPL3	25	26

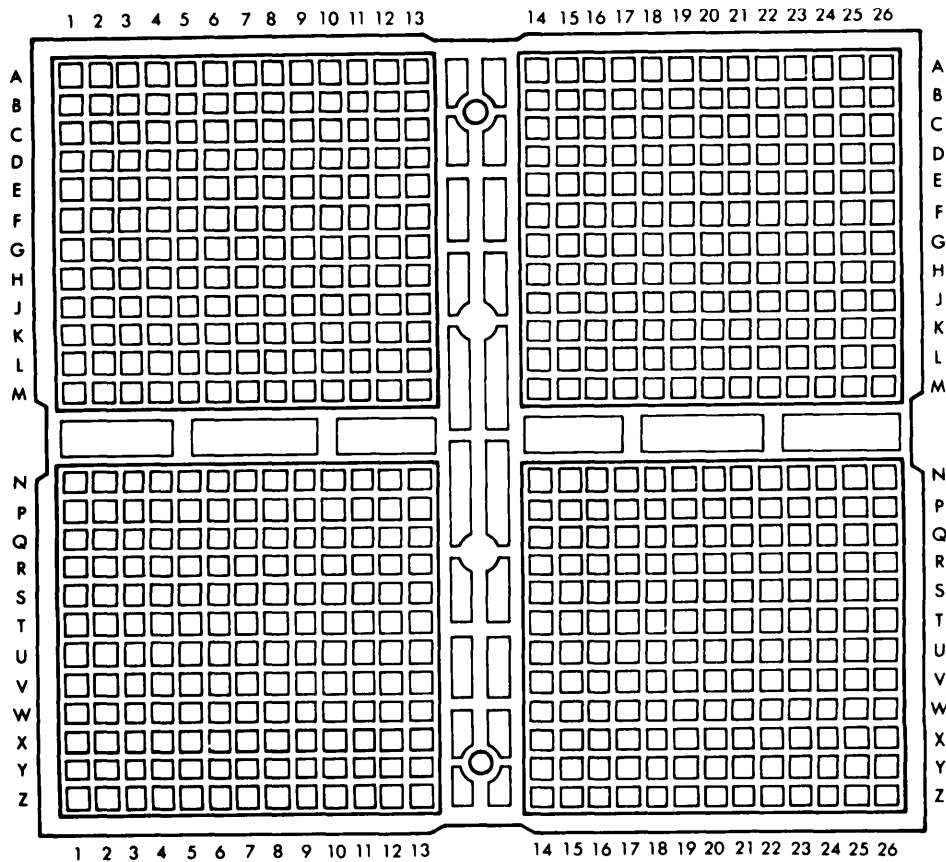

P1 - DL4-642RW4

EL9LQ-1000-30A

## 3-31. MAJOR TEST ADAPTER (cont)

3-31

FROM	TO	WIRE ID	WIRE SIZE	FROM	TO	WIRE ID	WIRE SIZE
P1-C9	17-36	25	26	P1-E5	SPL5	49	26
P1-C10	SPL3	27	26	P1-E6	16-23	49	26
P1-C11	16-37	27	26	P1-E8	SPL5	51	26
P1-C12	SPL3	29	26	P1-E9	17-24	51	26
P1-C12	SPL4	35	26	P1-E10	SPL7	55	26
P1-C13	17-38	29	26	P1-E11	16-25	55	26
P1-C14	STP570	1485	26	P1-E12	SPL7	57	26
P1-C15	15-12	1485	26	P1-E13	17-26	57	26
P1-C16	STP571	1487	26	P1-E14	STP552	1448	26
P1-C17	14-13	1487	26	P1-E15	29-94	1448	26
P1-C18	STP572	1489	26	P1-E16	STP553	1451	26
P1-C19	15-14	1489	26	P1-E17	28-97	1451	26
P1-C21	STP573	1491	26	P1-E18	STP554	1453	26
P1-C22	14-15	1491	26	P1-E19	29-96	1453	26
P1-C23	STP574	1494	26	P1-E21	STP555	1455	26
P1-C24	15-16	1494	26	P1-E22	29-98	1455	26
P1-C25	STP575	1496	26	P1-E23	STP556	1457	26
P1-C26	14-17	1496	26	P1-E24	32-33	1457	26
P1-D1	16-27	31	26	P1-E25	STP557	1459	26
P1-D2	SPL3	31	26	P1-E26	33-34	1459	26
P1-D3	17-28	33	26	P1-G1	16-15	59	26
P1-D4	SPL3	33	26	P1-G2	SPL7	59	26
P1-D5	16-29	37	26	P1-G3	17-16	61	26
P1-D6	SPL5	37	26	P1-G4	SPL7	61	26
P1-D8	17-30	39	26	P1-G5	16-17	63	26
P1-D9	SPL5	39	26	P1-G6	SPL7	63	26
P1-D10	16-31	41	26	P1-G8	17-18	65	26
P1-D11	SPL5	41	26	P1-G9	SPL7	65	26
P1-D12	17-32	43	26	P1-G10	16-19	67	26
P1-D13	SPL5	43	26	P1-G11	SPL7	67	26
P1-D13	SPL6	53	26	P1-G12	17-20	69	26
P1-D14	32-35	1461	26	P1-G13	SPL7	69	26
P1-D15	STP558	1461	26	P1-G13	SPL8	71	26
P1-D16	28-7	1463	26	P1-G14	29-88	1436	26
P1-D17	STP559	1463	26	P1-G15	STP546	1436	26
P1-D18	28-99	1465	26	P1-G16	28-89	1438	26
P1-D19	STP560	1465	26	P1-G17	STP547	1438	26
P1-D21	29-100	1467	26	P1-G18	29-90	1440	26
P1-D22	STP561	1467	26	P1-G19	STP548	1440	26
P1-D23	15-10	1481	26	P1-G21	28-91	1442	26
P1-D24	STP568	1481	26	P1-G22	STP549	1442	26
P1-D25	14-11	1483	26	P1-G23	29-92	1444	26
P1-D26	STP569	1483	26	P1-G24	STP550	1444	26
P1-E1	SPL5	45	26	P1-G25	28-93	1446	26
P1-E2	16-21	45	26	P1-G26	STP551	1446	26
P1-E3	SPL5	47	26	P1-H1	SPL9	73	26
P1-E4	17-22	47	26	P1-H2	J3-G1	73	26

## 3-31. MAJOR TEST ADAPTER (cont)

3-31

FROM	TO	WIRE ID	WIRE SIZE	FROM	TO	WIRE ID	WIRE SIZE
P1-H3	SPL9	75	26	P1-K1	SPL11	98	26
P1-H4	J3-G2	75	26	P1-K2	J3-J1	98	26
P1-H5	SPL9	77	26	P1-K3	SPL11	100	26
P1-H6	J3-G3	77	26	P1-K4	J3-J2	100	26
P1-H8	SPL9	79	26	P1-K5	SPL11	102	26
P1-H9	J3-G4	79	26	P1-K6	J3-J3	102	26
P1-H10	SPL9	81	26	P1-K8	SPL11	104	26
P1-H11	J3-G5	81	26	P1-K9	J3-J4	104	26
P1-H12	SPL9	83	26	P1-K10	SPL13	108	26
P1-H13	J3-G6	83	26	P1-K11	J3-J5	108	26
P1-H14	STP540	1424	26	P1-K12	SPL12	106	26
P1-H15	29-82	1424	26	P1-K12	SPL13	110	26
P1-H16	STP541	1426	26	P1-K13	J3-J6	110	26
P1-H17	28-83	1426	26	P1-K14	STP528	1398	26
P1-H18	STP542	1428	26	P1-K15	28-59	1398	26
P1-H19	29-84	1428	26	P1-K16	STP529	1400	26
P1-H21	STP543	1430	26	P1-K17	29-34	1400	26
P1-H22	28-85	1430	26	P1-K18	STP530	1402	26
P1-H23	STP544	1432	26	P1-K19	28-35	1402	26
P1-H24	29-86	1432	26	P1-K21	STP531	1404	26
P1-H25	STP545	1434	26	P1-K22	29-62	1404	26
P1-H26	28-87	1434	26	P1-K23	STP532	1407	26
P1-J1	J3-H1	85	26	P1-K24	28-63	1407	26
P1-J2	SPL9	85	26	P1-K25	STP533	1409	26
P1-J3	J3-H2	87	26	P1-K26	29-64	1409	26
P1-J4	SPL9	87	26	P1-L1	J3-K1	112	26
P1-J5	J3-H3	90	26	P1-L2	SPL13	112	26
P1-J6	SPL11	90	26	P1-L3	J3-K2	114	26
P1-J8	J3-H4	92	26	P1-L4	SPL13	114	26
P1-J9	SPL11	92	26	P1-L5	J3-K3	116	26
P1-J10	J3-H5	94	26	P1-L6	SPL13	116	26
P1-J11	SPL11	94	26	P1-L8	J3-K4	118	26
P1-J12	J3-H6	96	26	P1-L9	SPL13	118	26
P1-J13	SPL10	88	26	P1-L10	J3-K5	120	26
P1-J13	SPL11	96	26	P1-L11	SPL13	120	26
P1-J14	28-65	1411	26	P1-L12	J3-K6	122	26
P1-J15	STP534	1411	26	P1-L13	SPL13	122	26
P1-J16	29-66	1413	26	P1-L13	SPL14	124	26
P1-J17	STP535	1413	26	P1-L14	21-88	1475	26
P1-J18	28-67	1415	26	P1-L15	STP565	1475	26
P1-J19	STP536	1415	26	P1-L16	21-90	1477	26
P1-J21	29-68	1417	26	P1-L17	STP566	1477	26
P1-J22	STP537	1417	26	P1-L18	20-91	1479	26
P1-J23	28-69	1420	26	P1-L19	STP567	1479	26
P1-J24	STP538	1420	26	P1-L21	29-56	1392	26
P1-J25	28-81	1422	26	P1-L22	STP525	1392	26
P1-J26	STP539	1422	26	P1-L23	28-57	1394	26

## 3-31. MAJOR TEST ADAPTER (cont)

3-31

FROM	TO	WIRE ID	WIRE SIZE	FROM	TO	WIRE ID	WIRE SIZE
P1-L24	STP526	1394	26	P1-N22	STP519	1380	26
P1-L25	29-58	1396	26	P1-N23	J2-D6	1382	26
P1-L26	STP527	1396	26	P1-N24	STP520	1382	26
P1-M1	SPL15	126	26	P1-N25	J2-F5	1384	26
P1-M2	J3-L1	126	26	P1-N26	STP521	1384	26
P1-M3	SPL15	128	26	P1-P1	SPL18	152	26
P1-M4	J3-L2	128	26	P1-P2	J3-N1	152	26
P1-M5	SPL15	130	26	P1-P3	SPL18	154	26
P1-M6	J3-L3	130	26	P1-P4	J3-N2	154	26
P1-M8	SPL15	132	26	P1-P5	SPL18	156	26
P1-M9	J3-L4	132	26	P1-P6	J3-N3	156	26
P1-M10	SPL15	134	26	P1-P8	SPL18	158	26
P1-M11	J3-L5	134	26	P1-P9	J3-N4	158	26
P1-M12	SPL15	136	26	P1-P10	SPL20	162	26
P1-M12	SPL16	142	26	P1-P11	J3-N5	162	26
P1-M13	J3-L6	136	26	P1-P12	SPL17	160	26
P1-M14	STP522	1386	26	P1-P12	SPL20	164	26
P1-M15	J2-F6	1386	26	P1-P13	J3-N6	164	26
P1-M16	STP523	1388	26	P1-P14	STP510	1361	26
P1-M17	J2-G5	1388	26	P1-P15	J2-A2	1361	26
P1-M18	STP524	1390	26	P1-P16	STP511	1363	26
P1-M19	J2-G6	1390	26	P1-P17	J2-A4	1363	26
P1-M21	STP562	1469	26	P1-P18	STP512	1365	26
P1-M22	20-85	1469	26	P1-P19	J2-A6	1365	26
P1-M23	STP563	1471	26	P1-P21	STP513	1367	26
P1-M24	21-86	1471	26	P1-P22	J2-B2	1367	26
P1-M25	STP564	1473	26	P1-P23	STP514	1369	26
P1-M26	20-87	1473	26	P1-P24	J2-B4	1369	26
P1-N1	J3-M1	138	26	P1-P25	STP515	1371	26
P1-N2	SPL15	138	26	P1-P26	J2-B6	1371	26
P1-N3	J3-M2	140	26	P1-Q1	J2-U1	167	26
P1-N4	SPL15	140	26	P1-Q2	SPL21	167	26
P1-N5	J3-M3	144	26	P1-Q3	J2-U2	169	26
P1-N6	SPL18	144	26	P1-Q4	SPL21	169	26
P1-N8	J3-M4	146	26	P1-Q5	J2-U3	171	26
P1-N9	SPL18	146	26	P1-Q6	SPL21	171	26
P1-N10	J3-M5	148	26	P1-Q8	J2-U4	173	26
P1-N11	SPL18	148	26	P1-Q9	SPL21	173	26
P1-N11	SPL19	166	26	P1-Q10	J2-U5	175	26
P1-N12	J3-M6	150	26	P1-Q11	SPL21	175	26
P1-N13	SPL18	150	26	P1-Q12	J2-U6	177	26
P1-N14	J2-C2	1373	26	P1-Q13	SPL21	177	26
P1-N15	STP516	1373	26	P1-Q13	SPL22	179	26
P1-N16	J2-C4	1375	26	P1-Q14	J1-B4	1348	26
P1-N17	STP517	1375	26	P1-Q15	STP504	1348	26
P1-N18	J2-C6	1378	26	P1-Q16	J1-B5	1350	26
P1-N19	STP518	1378	26	P1-Q17	STP505	1350	26
P1-N21	J2-D4	1380	26				

## 3-31. MAJOR TEST ADAPTER (cont)

3-31

FROM	TO	WIRE ID	WIRE SIZE	FROM	TO	WIRE ID	WIRE SIZE
P1-Q18	J1-B6	1352	26	P1-S17	SPL20	209	26
P1-Q19	STP506	1352	26	P1-S18	14-9	1515	26
P1-Q21	J1-C1	1354	26	P1-S19	STP584	1515	26
P1-Q22	STP507	1354	26	P1-S21	J1-A1	1329	26
P1-Q23	J1-C2	1356	26	P1-S22	STP495	1329	26
P1-Q24	STP508	1356	26	P1-S23	J1-A2	1331	26
P1-Q25	J1-C3	1358	26	P1-S24	STP496	1331	26
P1-Q26	STP509	1358	26	P1-S25	J1-A3	1333	26
P1-R1	SPL24	181	26	P1-S26	STP497	1333	26
P1-R2	J2-V1	181	26	P1-U1	SPL26	211	26
P1-R3	SPL24	183	26	P1-U2	J2-X1	211	26
P1-R4	J2-V2	183	26	P1-U3	SPL26	213	26
P1-R5	SPL24	185	26	P1-U3	SPL25	215	26
P1-R6	J2-V3	185	26	P1-U4	J2-X2	213	26
P1-R8	SPL24	187	26	P1-U5	SPL28	217	26
P1-R9	J2-V4	187	26	P1-U6	J2-X3	217	26
P1-R10	SPL24	189	26	P1-U8	SPL28	219	26
P1-R11	J2-V5	189	26	P1-U9	J2-X4	219	26
P1-R12	SPL24	191	26	P1-U10	SPL28	221	26
P1-R13	J2-V6	191	26	P1-U11	J2-X5	221	26
P1-R14	STP498	1335	26	P1-U12	SPL28	223	26
P1-R15	J1-A4	1335	26	P1-U12	SPL27	233	26
P1-R16	STP499	1337	26	P1-U13	J2-X6	223	26
P1-R17	J1-A5	1337	26	P1-U14	SPL20	225	26
P1-R18	STP500	1339	26	P1-U15	J3-X5	225	26
P1-R19	J1-A6	1339	26	P1-U16	SPL20	227	26
P1-R21	STP501	1341	26	P1-U17	J3-X6	227	26
P1-R22	J1-B1	1341	26	P1-U18	SPL20	229	26
P1-R23	STP502	1343	26	P1-U19	J3-W1	229	26
P1-R24	J1-B2	1343	26	P1-U21	SPL20	231	26
P1-R25	STP503	1346	26	P1-U22	J3-W2	231	26
P1-R26	J1-B3	1346	26	P1-U23	SPL30	236	26
P1-S1	J2-W1	193	26	P1-U24	J3-W3	236	26
P1-S2	SPL24	193	26	P1-U25	SPL30	238	26
P1-S3	J2-W2	195	26	P1-U26	J3-W4	238	26
P1-S4	SPL24	195	26	P1-V1	J2-Y1	240	26
P1-S5	J2-W3	199	26	P1-V2	SPL31	240	26
P1-S6	SPL26	199	26	P1-V3	J2-Y2	242	26
P1-S8	J2-W4	201	26	P1-V4	SPL31	242	26
P1-S9	SPL26	201	26	P1-V5	J2-Y3	244	26
P1-S10	J2-W5	203	26	P1-V6	SPL31	244	26
P1-S11	SPL26	203	26	P1-V8	J2-Y4	246	26
P1-S12	J2-W6	205	26	P1-V9	SPL31	246	26
P1-S13	SPL26	205	26	P1-V10	J2-Y5	248	26
P1-S13	SPL23	197	26	P1-V11	SPL31	248	26
P1-S14	J3-W5	207	26	P1-V12	J2-Y6	250	26
P1-S15	SPL20	207	26	P1-V13	SPL31	250	26
P1-S16	J3-W6	209	26	P1-V13	SPL29	252	26

## 3-31. MAJOR TEST ADAPTER (cont)

3-31

FROM	TO	WIRE ID	WIRE SIZE	FROM	TO	WIRE ID	WIRE SIZE
P1-V14	J3-Y5	254	26	P1-X11	SPL37	301	26
P1-V15	SPL30	254	26	P1-X12	J2-a6	303	26
P1-V16	J3-Y6	256	26	P1-X13	SPL37	303	26
P1-V17	SPL30	256	26	P1-X13	SPL36	305	26
P1-V18	J3-X1	258	26	P1-X14	J3-a1	308	26
P1-V19	SPL30	258	26	P1-X15	SPL38	308	26
P1-V21	J3-X2	260	26	P1-X16	J3-a2	310	26
P1-V22	SPL30	260	26	P1-X17	SPL38	310	26
P1-V23	J3-X3	262	26	P1-X18	J3-Z1	312	26
P1-V24	SPL30	262	26	P1-X19	SPL38	312	26
P1-V25	J3-X4	264	26	P1-X21	J3-Z2	314	26
P1-V26	SPL30	264	26	P1-X22	SPL38	314	26
P1-W1	SPL33	266	26	P1-X23	J3-Z3	316	26
P1-W2	J2-Z1	266	26	P1-X24	SPL38	316	26
P1-W3	SPL33	268	26	P1-X25	J3-Z4	318	26
P1-W3	SPL32	270	26	P1-X26	SPL38	318	26
P1-W4	J2-Z2	268	26	P1-Y1	SPL38	320	26
P1-W5	SPL33	272	26	P1-Y2	J3-A4	320	26
P1-W6	J2-Z3	272	26	P1-Y3	SPL38	322	26
P1-W8	SPL33	274	26	P1-Y3	SPL39	324	26
P1-W9	J2-Z4	274	26	P1-Y4	J3-B4	322	26
P1-W10	SPL33	276	26	P1-Y5	SPL40	326	26
P1-W11	J2-Z5	276	26	P1-Y6	J3-C4	326	26
P1-W12	SPL33	278	26	P1-Y8	SPL40	328	26
P1-W13	J2-Z6	278	26	P1-Y9	J3-D4	328	26
P1-W14	SPL35	280	26	P1-Y10	SPL40	330	26
P1-W15	J3-Z5	280	26	P1-Y11	J3-E4	330	26
P1-W16	SPL35	282	26	P1-Y12	SPL40	332	26
P1-W17	J3-Z6	282	26	P1-Y12	SPL44	361	26
P1-W18	SPL35	284	26	P1-Y13	J3-F4	332	26
P1-W19	J3-Y1	284	26	P1-Y14	STP150	334	26
P1-W21	SPL35	286	26	P1-Y15	J4-R1	334	26
P1-W21	SPL34	288	26	P1-Y16	STP152	337	26
P1-W22	J3-Y2	286	26	P1-Y16	STP154	340	26
P1-W23	SPL35	289	26	P1-Y17	J4-R2	337	26
P1-W24	J3-Y3	289	26	P1-Y17	1-103	340	26
P1-W25	SPL35	291	26	P1-Y18	SPL41	343	26
P1-W26	J3-Y4	291	26	P1-Y21	SPL46	387	26
P1-X1	J2-a1	293	26	P1-Y23	SPL43	345	26
P1-X2	SPL37	293	26	P1-Y24	J2-F3	345	26
P1-X3	J2-a2	295	26	P1-Y25	SPL43	347	26
P1-X4	SPL37	295	26	P1-Y26	J2-D2	347	26
P1-X5	J2-a3	297	26	P1-Z1	J3-A6	349	26
P1-X6	SPL37	297	26	P1-Z2	SPL45	349	26
P1-X8	J2-a4	299	26	P1-Z3	J3-B6	351	26
P1-X9	SPL37	299	26	P1-Z4	SPL45	351	26
P1-X10	J2-a5	301	26	P1-Z5	J3-C6	353	26



FROM	TO	WIRE ID	WIRE SIZE	FROM	TO	WIRE ID	WIRE SIZE
P1-Z6	SPL45	353	26	OPEN	STP16	33	26
P1-Z8	J3-D6	355	26	OPEN	STP17	37	26
P1-Z9	SPL45	355	26	OPEN	STP18	39	26
P1-Z10	J3-E6	357	26	OPEN	STP19	41	26
P1-Z11	SPL45	357	26	OPEN	STP20	43	26
P1-Z12	J3-F6	359	26	OPEN	STP21	45	26
P1-Z13	SPL45	359	26	OPEN	STP22	47	26
P1-Z14	J4-P1	363	26	OPEN	STP23	49	26
P1-Z14	29-6	366	26	OPEN	STP24	51	26
P1-Z15	STP164	363	26	OPEN	STP25	55	26
P1-Z15	STP166	366	26	OPEN	STP26	57	26
P1-Z16	J4-P2	369	26	OPEN	STP27	59	26
P1-Z16	23-12	372	26	OPEN	STP28	61	26
P1-Z17	STP168	369	26	OPEN	STP29	63	26
P1-Z17	STP170	372	26	OPEN	STP30	65	26
P1-Z18	J4-P3	375	26	OPEN	STP31	67	26
P1-Z18	17-6	378	26	OPEN	STP32	69	26
P1-Z19	STP172	375	26	OPEN	STP33	73	26
P1-Z19	STP174	378	26	OPEN	STP34	75	26
P1-Z20	SPL47	400	26	OPEN	STP35	77	26
P1-Z21	J4-P4	381	26	OPEN	STP36	79	26
P1-Z21	10-9	384	26	OPEN	STP37	81	26
■ P1-Z22	STP176	381	26	OPEN	STP38	83	26
P1-Z22	STP178	384	26	OPEN	STP39	85	26
P1-Z23	J4-P5	388	26	OPEN	STP40	87	26
P1-Z23	4-11	391	26	OPEN	STP41	90	26
P1-Z24	STP180	388	26	OPEN	STP42	92	26
P1-Z24	STP182	391	26	OPEN	STP43	94	26
P1-Z25	J4-P6	394	26	OPEN	STP44	96	26
P1-Z25	J2-H1	397	26	OPEN	STP45	98	26
P1-Z26	STP184	394	26	OPEN	STP46	100	26
P1-Z26	STP186	397	26	OPEN	STP47	102	26
OPEN	STP1	1	26	OPEN	STP48	104	26
OPEN	STP2	3	26	OPEN	STP49	108	26
OPEN	STP3	5	26	OPEN	STP50	110	26
OPEN	STP4	7	26	OPEN	STP51	112	26
OPEN	STP5	9	26	OPEN	STP52	114	26
OPEN	STP6	11	26	OPEN	STP53	116	26
OPEN	STP7	13	26	OPEN	STP54	118	26
OPEN	STP8	15	26	OPEN	STP55	120	26
OPEN	STP9	19	26	OPEN	STP56	122	26
OPEN	STP10	21	26	OPEN	STP57	126	26
OPEN	STP11	23	26	OPEN	STP58	128	26
OPEN	STP12	25	26	OPEN	STP59	130	26
OPEN	STP13	27	26	OPEN	STP60	132	26
OPEN	STP14	29	26	OPEN	STP61	134	26
OPEN	STP15	31	26	OPEN	STP62	136	26

## 3-31. MAJOR TEST ADAPTER (cont)

3-31

FROM	TO	WIRE ID	WIRE SIZE	FROM	TO	WIRE ID	WIRE SIZE
OPEN	STP63	138	26	OPEN	STP109	244	26
OPEN	STP64	140	26	OPEN	STP110	246	26
OPEN	STP65	144	26	OPEN	STP111	248	26
OPEN	STP66	146	26	OPEN	STP112	250	26
OPEN	STP67	148	26	OPEN	STP113	254	26
OPEN	STP68	150	26	OPEN	STP114	256	26
OPEN	STP69	152	26	OPEN	STP115	258	26
OPEN	STP70	154	26	OPEN	STP116	260	26
OPEN	STP71	156	26	OPEN	STP117	262	26
OPEN	STP72	158	26	OPEN	STP118	264	26
OPEN	STP73	162	26	OPEN	STP119	266	26
OPEN	STP74	164	26	OPEN	STP120	268	26
OPEN	STP75	167	26	OPEN	STP121	272	26
OPEN	STP76	169	26	OPEN	STP122	274	26
OPEN	STP77	171	26	OPEN	STP123	276	26
OPEN	STP78	173	26	OPEN	STP124	278	26
OPEN	STP79	175	26	OPEN	STP125	280	26
OPEN	STP80	177	26	OPEN	STP126	282	26
OPEN	STP81	181	26	OPEN	STP127	284	26
OPEN	STP82	183	26	OPEN	STP128	286	26
OPEN	STP83	185	26	OPEN	STP129	289	26
OPEN	STP84	187	26	OPEN	STP130	291	26
OPEN	STP85	189	26	OPEN	STP131	293	26
OPEN	STP86	191	26	OPEN	STP132	295	26
OPEN	STP87	193	26	OPEN	STP133	297	26
OPEN	STP88	195	26	OPEN	STP134	299	26
OPEN	STP89	199	26	OPEN	STP135	301	26
OPEN	STP90	201	26	OPEN	STP136	303	26
OPEN	STP91	203	26	OPEN	STP137	308	26
OPEN	STP92	205	26	OPEN	STP138	310	26
OPEN	STP93	207	26	OPEN	STP139	312	26
OPEN	STP94	209	26	OPEN	STP140	314	26
OPEN	STP95	211	26	OPEN	STP141	316	26
OPEN	STP96	213	26	OPEN	STP142	318	26
OPEN	STP97	217	26	OPEN	STP143	320	26
OPEN	STP98	219	26	OPEN	STP144	322	26
OPEN	STP99	221	26	OPEN	STP145	326	26
OPEN	STP100	223	26	OPEN	STP146	328	26
OPEN	STP101	225	26	OPEN	STP147	330	26
OPEN	STP102	228	26	OPEN	STP148	332	26
OPEN	STP103	229	26	OPEN	STP155	345	26
OPEN	STP104	231	26	OPEN	STP156	347	26
OPEN	STP105	236	26	OPEN	STP157	349	26
OPEN	STP106	238	26	OPEN	STP158	351	26
OPEN	STP107	240	26	OPEN	STP159	353	26
OPEN	STP108	242	26	OPEN	STP160	355	26

3-31. MAJOR TEST ADAPTER (cont)

FROM	TO	WIRE ID	WIRE SIZE	FROM	TO	WIRE ID	WIRE SIZE
OPEN	STP161	357	26	OPEN	STP233	504	26
OPEN	STP162	359	26	OPEN	STP234	506	26
OPEN	STP187	403	26	OPEN	STP235	508	26
OPEN	STP188	405	26	OPEN	STP236	510	26
OPEN	STP189	407	26	OPEN	STP237	514	26
OPEN	STP190	409	26	OPEN	STP238	516	26
OPEN	STP191	411	26	OPEN	STP239	518	26
OPEN	STP192	413	26	OPEN	STP240	520	26
OPEN	STP193	415	26	OPEN	STP241	522	26
OPEN	STP194	417	26	OPEN	STP242	524	26
OPEN	STP195	421	26	OPEN	STP243	526	26
OPEN	STP196	423	26	OPEN	STP244	528	26
OPEN	STP197	426	26	OPEN	STP245	532	26
OPEN	STP198	427	26	OPEN	STP246	534	26
OPEN	STP199	429	26	OPEN	STP247	536	26
OPEN	STP200	431	26	OPEN	STP248	538	26
OPEN	STP201	433	26	OPEN	STP249	540	26
OPEN	STP202	435	26	OPEN	STP250	542	26
OPEN	STP205	442	26	OPEN	STP251	544	26
OPEN	STP206	444	26	OPEN	STP252	546	26
OPEN	STP207	446	26	OPEN	STP253	550	26
OPEN	STP208	448	26	OPEN	STP254	552	24
OPEN	STP209	450	26	OPEN	STP255	554	24
OPEN	STP210	452	26	OPEN	STP256	556	24
OPEN	STP211	454	26	OPEN	STP257	558	24
OPEN	STP212	456	26	OPEN	STP258	560	26
OPEN	STP213	460	26	OPEN	STP259	562	26
OPEN	STP214	462	26	OPEN	STP260	566	26
OPEN	STP215	464	26	OPEN	STP261	568	26
OPEN	STP216	466	26	OPEN	STP262	570	26
OPEN	STP217	468	26	OPEN	STP263	572	26
OPEN	STP218	470	26	OPEN	STP264	574	26
OPEN	STP219	472	26	OPEN	STP266	576	26
OPEN	STP220	474	26	OPEN	STP266	578	26
OPEN	STP221	478	26	OPEN	STP267	580	26
OPEN	STP222	480	26	OPEN	STP268	584	26
OPEN	STP223	482	26	OPEN	STP269	586	26
OPEN	STP224	484	26	OPEN	STP270	588	26
OPEN	STP225	486	26	OPEN	STP271	590	26
OPEN	STP226	488	26	OPEN	STP272	594	26
OPEN	STP227	490	26	OPEN	STP273	596	26
OPEN	STP228	492	26	OPEN	STP274	598	26
OPEN	STP229	496	26	OPEN	STP275	600	26
OPEN	STP230	498	26	OPEN	STP276	602	26
OPEN	STP231	500	26	OPEN	STP277	604	26
OPEN	STP232	502	26	OPEN	STP278	606	26

## 3-31. MAJOR TEST ADAPTER (cont)

3-31

FROM	TO	WIRE ID	WIRE SIZE	FROM	TO	WIRE ID	WIRE SIZE
OPEN	STP279	608	26	OPEN	STP381	804	26
OPEN	STP280	612	26	OPEN	STP382	806	26
OPEN	STP281	614	26	OPEN	STP383	808	26
OPEN	STP282	616	26	OPEN	STP384	810	26
OPEN	STP283	618	26	OPEN	STP385	812	26
OPEN	STP284	620	26	OPEN	STP386	814	26
OPEN	STP285	624	26	OPEN	STP387	816	26
OPEN	STP286	626	26	OPEN	STP388	818	26
OPEN	STP287	628	26	OPEN	STP389	822	26
OPEN	STP288	630	26	OPEN	STP390	824	26
OPEN	STP289	632	26	OPEN	STP391	826	26
OPEN	STP290	634	26	OPEN	STP392	828	26
OPEN	STP291	636	26	OPEN	STP393	830	26
OPEN	STP292	638	26	OPEN	STP394	832	26
OPEN	STP293	642	26	OPEN	STP395	834	26
OPEN	STP294	644	26	OPEN	STP396	836	26
OPEN	STP295	646	26	OPEN	STP437	906	26
OPEN	STP296	648	26	OPEN	STP438	908	26
OPEN	STP297	650	26	OPEN	STP439	910	26
OPEN	STP298	652	26	OPEN	STP442	915	26
OPEN	STP299	654	26	OPEN	STP443	917	26
OPEN	STP300	656	26	OPEN	STP446	923	26
OPEN	STP345	732	26	OPEN	STP447	925	26
OPEN	STP346	734	26	OPEN	STP448	927	26
OPEN	STP347	736	26	OPEN	STP449	929	26
OPEN	STP348	738	26	OPEN	STP450	931	26
OPEN	STP353	747	26	OPEN	STP451	935	26
OPEN	STP354	749	26	OPEN	STP452	937	26
OPEN	STP355	751	26	OPEN	STP453	939	26
OPEN	STP356	753	26	OPEN	STP454	941	26
OPEN	STP357	755	26	OPEN	STP455	943	26
OPEN	STP358	757	26	OPEN	STP456	945	26
OPEN	STP359	759	26	OPEN	STP457	947	26
OPEN	STP360	761	26	OPEN	STP458	949	26
OPEN	STP361	764	26	OPEN	STP475	979	26
OPEN	STP362	766	26	OPEN	STP476	981	26
OPEN	STP363	768	26	OPEN	STP477	983	26
OPEN	STP364	770	26	OPEN	STP478	985	26
OPEN	STP365	779	26	OPEN	STP479	987	26
OPEN	STP367	777	26	OPEN	STP480	989	26
OPEN	STP370	787	26	OPEN	STP481	991	26
OPEN	STP371	791	26	OPEN	STP482	993	26
OPEN	STP372	793	26	OPEN	STP483	1303	26
				OPEN	STP484	1305	26
				OPEN	STP485	1307	26

## 3-31. MAJOR TEST ADAPTER (cont)

3-31

FROM	TO	WIRE ID	WIRE SIZE	FROM	TO	WIRE ID	WIRE SIZE
OPEN	STP486	1309	26	OPEN	STP531	1404	26
OPEN	STP487	1311	26	OPEN	STP532	1407	26
OPEN	STP488	1313	26	OPEN	STP533	1409	26
OPEN	STP489	1316	26	OPEN	STP534	1411	26
OPEN	STP490	1318	26	OPEN	STP535	1413	26
OPEN	STP491	1320	26	OPEN	STP536	1415	26
OPEN	STP492	1322	26	OPEN	STP537	1417	26
OPEN	STP493	1324	26	OPEN	STP538	1420	26
OPEN	STP494	1326	26	OPEN	STP539	1422	26
OPEN	STP495	1329	26	OPEN	STP540	1424	26
OPEN	STP496	1331	26	OPEN	STP541	1426	26
OPEN	STP497	1333	26	OPEN	STP542	1428	26
OPEN	STP498	1335	26	OPEN	STP543	1430	26
OPEN	STP499	1337	26	OPEN	STP544	1432	26
OPEN	STP500	1339	26	OPEN	STP545	1434	26
OPEN	STP501	1341	26	OPEN	STP546	1436	26
OPEN	STP502	1343	26	OPEN	STP547	1438	26
OPEN	STP503	1346	26	OPEN	STP548	1440	26
OPEN	STP504	1348	26	OPEN	STP549	1442	26
OPEN	STP505	1350	26	OPEN	STP550	1444	26
OPEN	STP506	1352	26	OPEN	STP551	1446	26
OPEN	STP507	1354	26	OPEN	STP552	1448	26
OPEN	STP508	1356	26	OPEN	STP553	1452	26
OPEN	STP509	1358	26	OPEN	STP554	1453	26
OPEN	STP510	1361	26	OPEN	STP555	1455	26
OPEN	STP511	1363	26	OPEN	STP556	1457	26
OPEN	STP512	1365	26	OPEN	STP557	1459	26
OPEN	STP513	1367	26	OPEN	STP558	1461	26
OPEN	STP514	1369	26	OPEN	STP559	1463	26
OPEN	STP515	1371	26	OPEN	STP560	1465	26
OPEN	STP516	1373	26	OPEN	STP561	1467	26
OPEN	STP517	1375	26	OPEN	STP562	1469	26
OPEN	STP518	1378	26	OPEN	STP563	1471	26
OPEN	STP519	1380	26	OPEN	STP564	1473	26
OPEN	STP520	1382	26	OPEN	STP565	1475	26
OPEN	STP521	1384	26	OPEN	STP566	1477	26
OPEN	STP522	1386	26	OPEN	STP567	1479	26
OPEN	STP523	1388	26	OPEN	STP568	1481	26
OPEN	STP524	1390	26	OPEN	STP569	1483	26
OPEN	STP525	1392	26	OPEN	STP570	1485	26
OPEN	STP526	1394	26	OPEN	STP571	1487	26
OPEN	STP527	1396	26	OPEN	STP572	1489	26
OPEN	STP528	1398	26	OPEN	STP573	1491	26
OPEN	STP529	1400	26	OPEN	STP574	1494	26
OPEN	STP530	1402	26	OPEN	STP575	1496	26

## 3-31. MAJOR TEST ADAPTER (cont)

3-31

FROM	TO	WIRE ID	WIRE SIZE	FROM	TO	WIRE ID	WIRE SIZE
OPEN	STP576	1498	26	OPEN	STP620	1593	26
OPEN	STP577	1501	26	OPEN	STP621	1595	26
OPEN	STP578	1503	26	OPEN	STP622	1597	26
OPEN	STP579	1505	26	OPEN	STP623	1599	26
OPEN	STP580	1507	26	OPEN	STP624	1602	26
OPEN	STP581	1509	26	OPEN	STP625	1604	26
OPEN	STP582	1511	26	OPEN	STP626	1606	26
OPEN	STP583	1513	26	OPEN	STP627	1608	26
OPEN	STP584	1515	26	OPEN	STP628	1610	26
OPEN	STP585	1518	26	OPEN	STP629	1612	26
OPEN	STP586	1520	26	OPEN	STP630	1614	26
OPEN	STP587	1522	26	OPEN	STP631	1617	26
OPEN	STP588	1524	26	OPEN	STP632	1619	26
OPEN	STP589	1526	26	OPEN	STP633	1621	26
OPEN	STP590	1528	26	OPEN	STP634	1623	26
OPEN	STP591	1530	26	OPEN	STP635	1625	26
OPEN	STP592	1532	26	OPEN	STP636	1627	26
OPEN	STP593	1535	26	OPEN	STP637	1629	26
OPEN	STP594	1537	26	OPEN	STP638	1632	26
OPEN	STP595	1539	26	OPEN	STP639	1634	26
OPEN	STP596	1541	26	OPEN	STP640	1636	26
OPEN	STP597	1543	26	OPEN	STP641	1638	26
OPEN	STP598	1545	26	OPEN	STP642	1640	26
OPEN	STP599	1547	26	OPEN	STP643	1642	26
OPEN	STP600	1550	26	OPEN	STP644	1645	26
OPEN	STP601	1552	26	OPEN	STP645	1647	26
OPEN	STP602	1554	26	OPEN	STP646	1649	26
OPEN	STP603	1556	26	OPEN	STP647	1651	26
OPEN	STP604	1558	26	OPEN	STP648	1653	26
OPEN	STP605	1560	26	OPEN	STP649	1655	26
OPEN	STP606	1563	26	OPEN	STP650	1657	26
OPEN	STP607	1565	26	OPEN	STP651	1660	26
OPEN	STP608	1567	26	OPEN	STP652	1662	26
OPEN	STP609	1569	26	OPEN	STP653	1664	26
OPEN	STP610	1571	26	OPEN	STP654	1666	26
OPEN	STP611	1573	26	OPEN	STP655	1668	26
OPEN	STP612	1576	26	OPEN	STP656	1670	26
OPEN	STP613	1578	26	OPEN	STP657	1672	26
OPEN	STP614	1580	26	OPEN	STP658	1675	26
OPEN	STP615	1582	26	OPEN	STP659	1677	26
OPEN	STP616	1584	26	OPEN	STP660	1679	26
OPEN	STP617	1586	26	OPEN	STP661	1681	26
OPEN	STP618	1589	26	OPEN	STP662	1683	26
OPEN	STP619	1591	26	OPEN	STP663	1685	26

## 3-31. MAJOR TEST ADAPTER (cont)

3-31

FROM	TO	WIRE ID	WIRE SIZE	FROM	TO	WIRE ID	WIRE SIZE
OPEN	STP664	1687	26	OPEN	STP709	1784	26
OPEN	STP665	1689	26	OPEN	STP710	1786	26
OPEN	STP666	1691	26	OPEN	STP711	1789	26
OPEN	STP667	1693	26	OPEN	STP712	1791	26
OPEN	STP668	1695	26	OPEN	STP713	1793	26
OPEN	STP669	1697	26	OPEN	STP714	1795	26
OPEN	STP670	1700	26	OPEN	STP715	1797	26
OPEN	STP671	1702	26	OPEN	STP716	1799	26
OPEN	STP672	1704	26	OPEN	STP717	1801	26
OPEN	STP673	1706	26	OPEN	STP718	1804	26
OPEN	STP674	1708	26	OPEN	STP719	1806	26
OPEN	STP675	1710	26	OPEN	STP720	1808	26
OPEN	STP676	1713	26	OPEN	STP721	1810	26
OPEN	STP677	1715	26	OPEN	STP722	1812	26
OPEN	STP678	1717	26	OPEN	STP723	1815	26
OPEN	STP679	1719	26	OPEN	STP724	1817	26
OPEN	STP680	1721	26	OPEN	STP725	1819	26
OPEN	STP681	1723	26	OPEN	STP726	1821	26
OPEN	STP682	1725	26	OPEN	STP727	1823	26
OPEN	STP683	1727	26	OPEN	STP728	1825	26
OPEN	STP684	1730	26	OPEN	STP729	1827	26
OPEN	STP685	1732	26	OPEN	STP730	1829	26
OPEN	STP686	1734	26	OPEN	STP731	1832	26
OPEN	STP687	1736	26	OPEN	STP732	1834	26
OPEN	STP688	1738	26	OPEN	STP733	1836	26
OPEN	STP689	1740	26	OPEN	STP734	1838	26
OPEN	STP690	1742	26	OPEN	STP735	1840	26
OPEN	STP691	1745	26	OPEN	STP736	1842	26
OPEN	STP692	1747	26	OPEN	STP737	1844	26
OPEN	STP693	1749	26	OPEN	STP738	1847	26
OPEN	STP694	1751	26	OPEN	STP739	1849	26
OPEN	STP695	1753	26	OPEN	STP740	1851	26
OPEN	STP696	1755	26	OPEN	STP741	1853	26
OPEN	STP697	1758	26	OPEN	STP742	1855	26
OPEN	STP698	1760	26	OPEN	STP743	1857	26
OPEN	STP699	1762	26	OPEN	STP744	1859	26
OPEN	STP700	1764	26	OPEN	STP745	1862	26
OPEN	STP701	1766	26	OPEN	STP746	1864	26
OPEN	STP702	1768	26	OPEN	STP747	1866	26
OPEN	STP703	1770	26	OPEN	STP748	1868	26
OPEN	STP704	1774	26	OPEN	STP749	1871	26
OPEN	STP705	1776	26	OPEN	STP750	1873	26
OPEN	STP706	1778	26	OPEN	STP751	1875	26
OPEN	STP707	1780	26	OPEN	STP752	1877	26
OPEN	STP708	1782	26	OPEN	STP753	1879	26

## 3-31. MAJOR TEST ADAPTER (cont)

3-31

FROM	TO	WIRE ID	WIRE SIZE	FROM	TO	WIRE ID	WIRE SIZE
OPEN	STP754	1881	26	SPL4	STP14	30	26
OPEN	STP755	1883	26	SPL4	STP15	32	26
OPEN	STP756	1885	26	SPL4	STP16	34	26
OPEN	STP757	1888	26	SPL4	P1-C12	35	26
OPEN	STP758	1890	26	SPL5	P1-D6	37	26
OPEN	STP759	1892	26	SPL5	P1-D9	39	26
OPEN	STP760	1894	26	SPL5	P1-D11	41	26
OPEN	STP761	1896	26	SPL5	P1-D13	43	26
OPEN	STP762	1898	26	SPL5	P1-E1	45	26
OPEN	STP763	1900	26	SPL5	P1-E3	47	26
OPEN	STP764	773	26	SPL5	P1-E5	49	26
OPEN	STP765	775	26	SPL5	P1-E8	51	26
SPL1	STP1	1	26	SPL5	SPL7	54	26
SPL1	STP2	1	26	SPL6	STP17	38	26
SPL1	STP2	3	26	SPL6	STP18	40	26
SPL1	STP3	6	26	SPL6	STP19	42	26
SPL1	STP4	8	26	SPL6	STP20	44	26
SPL1	STP5	10	26	SPL6	STP21	46	26
SPL1	STP6	12	26	SPL6	STP22	48	26
SPL1	STP7	14	26	SPL6	STP23	50	26
SPL1	STP8	16	26	SPL6	STP24	52	26
SPL1	P1-B13	17	26	SPL6	P1-D13	53	26
SPL2	P1-A1	1	26	SPL7	SPL5	54	26
SPL2	P1-A3	3	26	SPL7	P1-E10	55	26
SPL2	P1-B2	5	26	SPL7	P1-E12	57	26
SPL2	P1-B4	7	26	SPL7	P1-G2	59	26
SPL2	P1-B6	9	26	SPL7	P1-G4	61	26
SPL2	P1-B9	11	26	SPL7	P1-G6	63	26
SPL2	P1-B11	13	26	SPL7	P1-G9	65	26
SPL2	P1-B13	15	26	SPL7	P1-G11	67	26
SPL2	SPL3	18	26	SPL7	P1-G13	69	26
SPL3	SPL2	18	26	SPL7	17-70	72	26
SPL3	P1-C1	19	26	SPL8	STP25	56	26
SPL3	P1-C3	21	26	SPL8	STP26	58	26
SPL3	P1-C5	23	26	SPL8	STP27	60	26
SPL3	P1-C8	25	26	SPL8	STP28	62	26
SPL3	P1-C10	27	26	SPL8	STP29	64	26
SPL3	P1-C12	29	26	SPL8	STP30	66	26
SPL3	P1-D2	31	26	SPL8	STP31	68	26
SPL3	P1-D4	33	26	SPL8	STP32	70	26
SPL3	16-71	36	26	SPL8	P1-G13	71	26
SPL4	P1-C12	35	26	SPL9	P1-H1	73	26
SPL4	STP9	20	26	SPL9	P1-H3	75	26
SPL4	STP10	22	26	SPL9	P1-H5	77	26
SPL4	STP11	24	26	SPL9	P1-H8	79	26
SPL4	STP12	26	26	SPL9	P1-H10	81	26
SPL4	STP13	27	26				



## 3-31. MAJOR TEST ADAPTER (cont)

3-31

FROM	TO	WIRE ID	WIRE SIZE	FROM	TO	WIRE ID	WIRE SIZE
SPL9	P1-H12	83	26	SPL14	STP53	117	26
SPL9	P1-J2	85	26	SPL14	STP54	119	26
SPL9	P1-J4	87	26	SPL14	STP55	121	26
SPL9	J3-U2	89	26	SPL14	STP56	123	26
SPL10	STP33	74	26	SPL14	P1-L13	124	26
SPL10	STP34	76	26	SPL15	SPL13	125	26
SPL10	STP35	78	26	SPL15	P1-M1	126	26
SPL10	STP36	80	26	SPL15	P1-M3	128	26
SPL10	STP37	82	26	SPL15	P1-M5	130	26
SPL10	STP38	84	26	SPL15	P1-M8	132	26
SPL10	STP39	86	26	SPL15	P1-M10	134	26
SPL10	STP40	87	26	SPL15	P1-M12	136	26
SPL10	P1-J13	88	26	SPL15	P1-N2	138	26
SPL11	P1-J6	90	26	SPL15	P1-N4	140	26
SPL11	P1-J9	92	26	SPL15	SPL18	143	26
SPL11	P1-J11	94	26	SPL16	STP57	127	26
SPL11	P1-J13	96	26	SPL16	STP58	129	26
SPL11	P1-K1	98	26	SPL16	STP59	131	26
SPL11	P1-K3	100	26	SPL16	STP60	133	26
SPL11	P1-K5	102	26	SPL16	STP61	135	26
SPL11	P1-K8	104	26	SPL16	STP62	137	26
SPL11	SPL13	107	26	SPL16	STP63	139	26
SPL12	STP41	91	26	SPL16	STP64	141	26
SPL12	STP42	93	26	SPL16	P1-M12	142	26
SPL12	STP43	94	26	SPL17	STP65	145	26
SPL12	STP44	97	26	SPL17	STP66	147	26
SPL12	STP45	99	26	SPL17	STP67	149	26
SPL12	STP46	101	26	SPL17	STP68	151	26
SPL12	STP47	103	26	SPL17	STP69	153	26
SPL12	STP48	105	26	SPL17	STP70	155	26
SPL12	P1-K12	106	26	SPL17	STP71	157	26
SPL13	SPL11	107	26	SPL17	STP72	159	26
SPL13	P1-K10	108	26	SPL17	P1-P12	160	26
SPL13	P1-K12	110	26	SPL18	SPL15	143	26
SPL13	P1-L2	112	26	SPL18	P1-N6	144	26
SPL13	P1-L4	114	26	SPL18	P1-N9	146	26
SPL13	P1-L6	116	26	SPL18	P1-N11	148	26
SPL13	P1-L9	118	26	SPL18	P1-N13	150	26
SPL13	P1-L11	120	26	SPL18	P1-P1	152	26
SPL13	P1-L13	122	26	SPL18	P1-P3	154	26
SPL13	SPL15	125	26	SPL18	P1-P5	156	26
SPL14	STP49	109	26	SPL18	P1-P8	158	26
SPL14	STP50	111	26	SPL18	SPL20	161	26
SPL14	STP51	113	26	SPL19	STP73	163	26
SPL14	STP52	115	26	SPL19	STP74	165	26

## 3-31. MAJOR TEST ADAPTER (cont)

3-31

FROM	TO	WIRE ID	WIRE SIZE	FROM	TO	WIRE ID	WIRE SIZE
SPL19	P1-N11	166	26	SPL25	STP89	200	26
SPL20	SPL18	161	26	SPL25	STP90	202	26
SPL20	P1-P10	162	26	SPL25	STP91	204	26
SPL20	P1-P12	164	26	SPL25	STP92	206	26
SPL20	P1-S15	107	26	SPL25	STP93	208	26
SPL20	P1-S17	209	26	SPL25	STP94	210	26
SPL20	P1-U14	225	26	SPL25	STP95	212	26
SPL20	P1-U16	227	26	SPL25	STP96	214	26
SPL20	P1-U18	229	26	SPL25	P1-U3	215	26
SPL20	P1-U21	231	26	SPL26	SPL24	198	26
SPL20	SPL30	234	26	SPL26	P1-S6	199	26
SPL21	P1-Q2	167	26	SPL26	P1-S9	201	26
SPL21	P1-Q4	169	26	SPL26	P1-S11	203	26
SPL21	P1-Q6	171	26	SPL26	P1-S13	205	26
SPL21	P1-Q9	173	26	SPL26	P1-U1	211	26
SPL21	P1-Q11	175	26	SPL26	P1-U3	213	26
SPL21	P1-Q13	177	26	SPL26	SPL28	216	26
SPL21	SPL24	180	26	SPL27	STP97	218	26
SPL22	STP75	168	26	SPL27	STP98	220	26
SPL22	STP76	170	26	SPL27	STP99	222	26
SPL22	STP77	172	26	SPL27	STP100	224	26
SPL22	STP78	174	26	SPL27	STP101	226	26
SPL22	STP79	176	26	SPL27	STP102	228	26
SPL22	STP80	178	26	SPL27	STP103	230	26
SPL22	P1-Q13	179	26	SPL27	STP104	232	26
SPL23	STP81	182	26	SPL27	P1-U12	233	26
SPL23	STP82	184	26	SPL28	SPL26	216	26
SPL23	STP83	186	26	SPL28	P1-U5	217	26
SPL23	STP84	188	26	SPL28	P1-U8	219	26
SPL23	STP85	190	26	SPL28	P1-U10	221	26
SPL23	STP86	192	26	SPL28	P1-U12	223	26
SPL23	STP87	194	26	SPL28	SPL31	235	26
SPL23	STP88	196	26	SPL29	STP105	237	26
SPL23	P1-S13	197	26	SPL29	STP106	239	26
SPL24	SPL21	180	26	SPL29	STP107	241	26
SPL24	P1-R1	181	26	SPL29	STP108	243	26
SPL24	P1-R3	183	26	SPL29	STP109	245	26
SPL24	P1-R5	185	26	SPL29	STP110	247	26
SPL24	P1-R8	187	26	SPL29	STP111	249	26
SPL24	P1-R10	189	26	SPL29	STP112	251	26
SPL24	P1-R12	191	26	SPL29	P1-V13	252	26
SPL24	P1-S2	193	26	SPL30	SPL20	234	26
SPL24	P1-S4	195	26	SPL30	P1-U23	236	26
SPL24	SPL26	198	26	SPL30	P1-U25	238	26

3-31. MAJOR TEST ADAPTER (cont)

FROM	TO	WIRE ID	WIRE SIZE	FROM	TO	WIRE ID	WIRE SIZE
SPL 30	P1-V15	254	26	SPL 35	P1-W25	291	26
SPL 30	P1-V17	256	26	SPL 35	SPL 38	306	26
SPL 30	P1-V19	258	26	SPL 36	STP129	290	26
SPL 30	P1-V22	260	26	SPL 36	STP130	292	26
SPL 30	P1-V24	262	26	SPL 36	STP131	294	26
SPL 30	P1-V26	264	26	SPL 36	STP132	296	26
SPL 30	J3-V2	271	26	SPL 36	STP133	298	26
SPL 31	SPL 28	235	26	SPL 36	STP134	300	26
SPL 31	P1-V2	240	26	SPL 36	STP135	302	26
SPL 31	P1-V4	242	26	SPL 36	STP136	304	26
SPL 31	P1-V6	244	26	SPL 36	P1-X13	305	26
SPL 31	P1-V9	246	26	SPL 37	SPL 33	288A	26
SPL 31	P1-V11	248	26	SPL 37	P1-X2	293	26
SPL 31	P1-V13	250	26	SPL 37	P1-X4	295	26
SPL 31	J2-E6	253	26	SPL 37	P1-X6	297	26
SPL 32	STP113	255	26	SPL 37	P1-X9	299	26
SPL 32	STP114	257	26	SPL 37	P1-X11	301	26
SPL 32	STP115	259	26	SPL 37	P1-X13	303	26
SPL 32	STP116	261	26	SPL 37	J2-E4	307	26
SPL 32	STP117	263	26	SPL 38	SPL 35	306	26
SPL 32	STP118	265	26	SPL 38	P1-X15	308	26
SPL 32	STP119	267	26	SPL 38	P1-X17	310	26
SPL 32	STP120	269	26	SPL 38	P1-X19	312	26
SPL 32	P1-W3	270	26	SPL 38	P1-X22	314	26
SPL 33	P1-W1	266	26	SPL 38	P1-X24	316	26
SPL 33	P1-W3	268	26	SPL 38	P1-X26	318	26
SPL 33	P1-W5	272	26	SPL 38	P1-Y1	320	26
SPL 33	P1-W8	274	26	SPL 38	P1-Y3	322	26
SPL 33	P1-W10	276	26	SPL 38	SPL 40	325	26
SPL 33	P1-W12	278	26	SPL 39	STP137	309	26
SPL 33	SPL 37	288	26	SPL 39	STP138	311	26
SPL 34	STP121	273	26	SPL 39	STP139	313	26
SPL 34	STP122	275	26	SPL 39	STP140	315	26
SPL 34	STP123	277	26	SPL 39	STP141	317	26
SPL 34	STP124	279	26	SPL 39	STP142	319	26
SPL 34	STP125	281	26	SPL 39	STP143	321	26
SPL 34	STP126	283	26	SPL 39	STP144	323	26
SPL 34	STP127	285	26	SPL 39	P1-Y3	324	26
SPL 34	STP128	287	26	SPL 40	SPL 38	325	26
SPL 34	P1-W21	288	26	SPL 40	P1-Y5	326	26
SPL 35	P1-W14	280	26	SPL 40	P1-Y8	328	26
SPL 35	P1-W16	282	26	SPL 40	P1-Y10	330	26
SPL 35	P1-W18	284	26	SPL 40	P1-Y12	332	26
SPL 35	P1-W21	286	26	SPL 40	SPL 45	344	26
SPL 35	P1-W23	289	26	SPL 41	STP145	327	26

## 3-31. MAJOR TEST ADAPTER (cont)

3-31

FROM	TO	WIRE ID	WIRE SIZE	FROM	TO	WIRE ID	WIRE SIZE
SPL41	STP146	329	26	SPL46	P1-Y21	387	26
SPL41	STP147	331	26	SPL47	STP179	389	26
SPL41	STP148	333	26	SPL47	STP181	392	26
SPL41	STP149	335	26	SPL47	STP183	395	26
SPL41	STP151	338	26	SPL47	STP185	398	26
SPL41	STP153	341	26	SPL47	P1-Z20	400	26
SPL41	P1-Y18	343	26	SPL48	STP187	403	26
SPL42	STP150	336	26	SPL48	STP188	405	26
SPL42	STP152	339	26	SPL48	STP189	407	26
SPL42	STP164	365	26	SPL48	STP190	409	26
SPL42	STP168	371	26	SPL48	STP191	411	26
SPL42	STP172	377	26	SPL48	STP192	413	26
SPL42	STP176	383	26	SPL48	STP193	415	26
SPL42	STP180	390	26	SPL48	STP194	417	26
SPL42	STP184	396	26	SPL48	SPL50	419	26
SPL42	J4-D5	401	26	SPL49	STP187	404	26
SPL43	P1-Y23	345	26	SPL49	STP188	406	26
SPL43	P1-Y25	347	26	SPL49	STP189	408	26
SPL43	STP186	399	26	SPL49	STP190	410	26
SPL43	J2-E4	402	26	SPL49	STP191	412	26
SPL44	STP155	346	26	SPL49	STP192	414	26
SPL44	STP156	348	26	SPL49	STP193	416	26
SPL44	STP157	350	26	SPL49	STP194	418	26
SPL44	STP158	352	26	SPL49	SPL51	420	26
SPL44	STP159	354	26	SPL50	SPL48	419	26
SPL44	STP160	356	26	SPL50	STP195	421	26
SPL44	STP161	358	26	SPL50	STP196	423	26
SPL44	STP162	360	26	SPL50	STP197	425	26
SPL44	P1-Y12	361	26	SPL50	STP198	427	26
SPL45	SPL40	344	26	SPL50	STP199	429	26
SPL45	P1-Z2	349	26	SPL50	STP200	431	26
SPL45	P1-Z4	351	26	SPL50	STP201	433	26
SPL45	P1-Z6	353	26	SPL50	STP202	435	26
SPL45	P1-Z9	355	26	SPL50	STP203	438	26
SPL45	P1-Z11	357	26	SPL50	SPL52	440	26
SPL45	P1-Z13	359	26	SPL51	SPL49	420	26
SPL45	J3-F3	362	26	SPL51	STP195	422	26
SPL46	STP163	364	26	SPL51	STP196	424	26
SPL46	STP165	367	26	SPL51	STP197	426	26
SPL46	STP167	370	26	SPL51	STP198	428	26
SPL46	STP169	373	26	SPL51	STP199	430	26
SPL46	STP171	376	26	SPL51	STP200	432	26
SPL46	STP173	379	26	SPL51	STP201	434	26
SPL46	STP175	382	26	SPL51	STP202	436	26
SPL46	STP177	385	26	SPL51	J4-D2	441	26

## 3-31. MAJOR TEST ADAPTER (cont)

3-31

FROM	TO	WIRE ID	WIRE SIZE	FROM	TO	WIRE ID	WIRE SIZE
SPL52	SPL50	440	26	SPL56	STP227	490	26
SPL52	STP205	442	26	SPL56	STP228	492	26
SPL52	STP206	444	26	SPL56	J2-E2	494	26
SPL52	STP207	446	26	SPL57	STP221	479	26
SPL52	STP208	448	26	SPL57	STP222	481	26
SPL52	STP209	450	26	SPL57	STP223	483	26
SPL52	STP210	452	26	SPL57	STP224	484	26
SPL52	STP211	454	26	SPL57	STP225	487	26
SPL52	STP212	456	26	SPL57	STP226	489	26
SPL52	SPL54	458	26	SPL57	STP227	491	26
SPL53	STP205	443	26	SPL57	STP228	493	26
SPL53	STP206	445	26	SPL57	20-5	495	26
SPL53	STP207	447	26	SPL58	STP229	496	26
SPL53	STP208	448	26	SPL58	STP230	498	26
SPL53	STP209	451	26	SPL58	STP231	500	26
SPL53	STP210	453	26	SPL58	STP232	502	26
SPL53	STP211	455	26	SPL58	STP233	504	26
SPL53	STP212	457	26	SPL58	STP234	506	26
SPL53	17-107	459	26	SPL58	STP235	508	26
SPL54	SPL52	458	26	SPL58	STP236	510	26
SPL54	STP213	460	26	SPL58	SPL60	513	26
SPL54	STP214	462	26	SPL59	STP229	497	26
SPL54	STP215	464	26	SPL59	STP230	499	26
SPL54	STP216	466	26	SPL59	STP231	501	26
SPL54	STP217	468	26	SPL59	STP232	503	26
SPL54	STP218	470	26	SPL59	STP233	505	26
SPL54	STP219	472	26	SPL59	STP234	507	26
SPL54	STP220	474	26	SPL59	STP235	509	26
SPL54	SPL56	477	26	SPL59	STP236	511	26
SPL55	STP213	461	26	SPL59	21-5	512	26
SPL55	STP214	463	26	SPL60	SPL58	513	26
SPL55	STP215	465	26	SPL60	STP237	514	26
SPL55	STP216	467	26	SPL60	STP238	516	26
SPL55	STP217	469	26	SPL60	STP239	518	26
SPL55	STP218	471	26	SPL60	STP240	520	26
SPL55	STP219	473	26	SPL60	STP241	522	26
SPL55	STP220	475	26	SPL60	STP242	524	26
SPL55	21-5	476	26	SPL60	STP243	526	26
SPL56	SPL54	477	26	SPL60	STP244	528	26
SPL56	STP221	478	26	SPL60	J2-E6	530	26
SPL56	STP222	480	26	SPL61	STP237	515	26
SPL56	STP223	482	26	SPL61	STP238	517	26
SPL56	STP224	484	26	SPL61	STP239	519	26
SPL56	STP225	486	26	SPL61	STP240	521	26
SPL56	STP226	488	26	SPL61	STP241	523	26

## 3-31. MAJOR TEST ADAPTER (cont)

3-31

FROM	TO	WIRE ID	WIRE SIZE	FROM	TO	WIRE ID	WIRE SIZE
SPL 61	STP242	524	26	SPL 66	STP267	580	26
SPL 61	STP243	527	26	SPL 66	SPL 68	583	26
SPL 61	STP244	529	26	SPL 67	STP260	567	26
SPL 61	32-5	531	26	SPL 67	STP261	569	26
SPL 62	STP245	532	26	SPL 67	STP262	571	26
SPL 62	STP246	534	26	SPL 67	STP263	573	26
SPL 62	STP247	536	26	SPL 67	STP264	575	26
SPL 62	STP248	538	26	SPL 67	STP265	577	26
SPL 62	STP249	540	26	SPL 67	STP266	579	26
SPL 62	STP250	542	26	SPL 67	STP267	581	26
SPL 62	STP251	544	26	SPL 67	10-107	582	26
SPL 62	STP252	546	26	SPL 68	SPL 66	583	26
SPL 62	SPL 64	549	26	SPL 68	STP268	584	26
SPL 63	STP245	532	26	SPL 68	STP269	586	26
SPL 63	STP246	535	26	SPL 68	STP270	588	26
SPL 63	STP247	537	26	SPL 68	STP271	590	26
SPL 63	STP248	539	26	SPL 68	J2-F2	592	26
SPL 63	STP249	541	26	SPL 69	STP268	585	26
SPL 63	STP250	543	26	SPL 69	STP269	587	26
SPL 63	STP251	545	26	SPL 69	STP270	589	26
SPL 63	STP252	547	26	SPL 69	STP271	591	26
SPL 63	33-5	548	26	SPL 69	11-107	593	26
SPL 64	SPL 62	549	26	SPL 70	STP272	594	26
SPL 64	STP253	550	26	SPL 70	STP273	596	26
SPL 64	STP254	552	24	SPL 70	STP274	598	26
SPL 64	STP255	554	24	SPL 70	STP275	600	26
SPL 64	STP256	556	24	SPL 70	STP276	602	26
SPL 64	STP257	558	24	SPL 70	STP277	604	26
SPL 64	STP258	560	26	SPL 70	STP278	606	26
SPL 64	STP259	562	26	SPL 70	STP279	608	26
SPL 64	J2-F2	564	26	SPL 70	J3-F2	610	26
SPL 65	STP253	551	26	SPL 71	STP272	595	26
SPL 65	STP254	553	24	SPL 71	STP273	597	26
SPL 65	STP255	555	24	SPL 71	STP274	599	26
SPL 65	STP256	557	24	SPL 71	STP275	601	26
SPL 65	STP257	559	24	SPL 71	STP276	603	26
SPL 65	STP258	561	26	SPL 71	16-106	611	26
SPL 65	STP259	562	26	SPL 72	STP277	605	26
SPL 65	28-5	565	26	SPL 72	STP278	607	26
SPL 66	STP260	566	26	SPL 72	STP279	609	26
SPL 66	STP261	568	26	SPL 72	STP280	613	26
SPL 66	STP262	571	26	SPL 72	STP281	615	26
SPL 66	STP263	572	26	SPL 72	STP282	617	26
SPL 66	STP264	574	26	SPL 72	STP283	619	26
SPL 66	STP265	576	26	SPL 72	STP284	621	26
SPL 66	STP266	578	26	SPL 72	J4-D3	623	26

FROM	TO	WIRE ID	WIRE SIZE	FROM	TO	WIRE ID	WIRE SIZE
SPL 73	STP280	612	26	SPL 78	STP307	670	26
SPL 73	STP281	614	26	SPL 78	STP309	673	26
SPL 73	STP282	616	26	SPL 78	STP311	676	26
SPL 73	STP283	618	26	SPL 78	J4-D6	678	26
SPL 73	STP284	620	26	SPL 79	STP302	662	26
SPL 73	J3-U4	622	26	SPL 79	STP304	665	26
SPL 74	STP285	625	26	SPL 79	STP306	668	26
SPL 74	STP286	627	26	SPL 79	STP308	671	26
SPL 74	STP287	629	26	SPL 79	STP310	674	26
SPL 74	STP288	631	26	SPL 79	STP312	677	26
SPL 74	STP289	633	26	SPL 79	18-46	679	26
SPL 74	STP290	635	26	SPL 80	STP313	681	26
SPL 74	STP291	637	26	SPL 80	STP315	684	26
SPL 74	STP292	639	26	SPL 80	STP317	687	26
SPL 74	J4-C5	640	26	SPL 80	STP319	690	26
SPL 75	STP285	624	26	SPL 80	STP321	693	26
SPL 75	STP286	626	26	SPL 80	STP323	696	26
SPL 75	STP287	628	26	SPL 80	STP325	699	26
SPL 75	STP288	630	26	SPL 80	STP327	702	26
SPL 75	STP289	632	26	SPL 80	J4-D4	704	26
SPL 75	STP290	634	26	SPL 81	STP314	682	26
SPL 75	STP291	636	26	SPL 81	STP316	685	26
SPL 75	STP292	638	26	SPL 81	STP318	688	26
SPL 75	20-3	641	26	SPL 81	STP320	691	26
SPL 76	STP293	643	26	SPL 81	STP322	694	26
SPL 76	STP294	645	26	SPL 81	STP324	697	26
SPL 76	STP295	647	26	SPL 81	STP326	700	26
SPL 76	STP296	649	26	SPL 81	SPL 83	705	26
SPL 76	STP297	651	26	SPL 82	STP329	707	26
SPL 76	STP298	653	26	SPL 82	STP331	710	26
SPL 76	STP299	655	26	SPL 82	STP333	713	26
SPL 76	STP300	657	26	SPL 82	STP335	716	26
SPL 76	J4-C6	658	26	SPL 82	STP337	719	26
SPL 77	STP293	642	26	SPL 82	STP339	722	26
SPL 77	STP294	644	26	SPL 82	STP341	725	26
SPL 77	STP295	646	26	SPL 82	STP343	728	26
SPL 77	STP296	648	26	SPL 82	J4-D1	730	26
SPL 77	STP297	650	26	SPL 83	SPL 81	705	26
SPL 77	STP298	652	26	SPL 83	STP330	708	26
SPL 77	STP299	654	26	SPL 83	STP332	711	26
SPL 77	STP300	656	26	SPL 83	STP334	714	26
SPL 77	J3-F2	659	26	SPL 83	STP336	717	26
SPL 78	STP301	661	26	SPL 83	STP338	720	26
SPL 78	STP303	664	26	SPL 83	STP340	723	26
SPL 78	STP305	667	26	SPL 83	STP342	726	26
				SPL 83	STP344	729	26

## 3-31. MAJOR TEST ADAPTER (cont)

3-31

FROM	TO	WIRE ID	WIRE SIZE	FROM	TO	WIRE ID	WIRE SIZE
SPL83	23-52	731	26	SPL91	STP381	804	26
SPL84	STP345	733	26	SPL91	STP382	806	26
SPL84	STP346	735	26	SPL91	STP383	808	26
SPL84	STP347	737	26	SPL91	STP384	810	26
SPL84	STP348	739	26	SPL91	STP385	812	26
SPL84	STP349	741	26	SPL91	STP386	814	26
SPL84	STP351	744	26	SPL91	STP387	816	26
SPL84	J4-D2	746	26	SPL91	STP388	818	26
SPL85	STP353	748	26	SPL91	22-5	821	26
SPL85	STP354	750	26	SPL92	STP389	823	26
SPL85	STP355	752	26	SPL92	STP390	825	26
SPL85	STP356	754	26	SPL92	STP391	827	26
SPL85	STP357	756	26	SPL92	STP392	829	26
SPL85	STP358	758	26	SPL92	STP393	831	26
SPL85	STP359	760	26	SPL92	STP394	833	26
SPL85	STP360	762	26	SPL92	STP395	835	26
SPL85	J4-D1	763	26	SPL92	STP396	837	26
SPL86	STP361	765	26	SPL92	5-28	838	26
SPL86	STP362	767	26	SPL93	STP389	822	26
SPL86	STP363	769	26	SPL93	STP390	824	26
SPL86	STP364	771	26	SPL93	STP391	826	26
SPL86	J4-C5	772	26	SPL93	STP392	828	26
SPL87	STP365	780	26	SPL93	STP393	830	26
SPL87	STP366	782	26	SPL93	STP394	832	26
SPL87	STP367	778	26	SPL93	STP395	834	26
SPL87	STP368	785	26	SPL93	STP396	836	26
SPL87	STP370	788	26	SPL93	4-5	839	26
SPL87	STP764	774	26	SPL94	STP397	841	26
SPL87	STP765	776	26	SPL94	STP399	844	26
SPL87	J4-C6	789	26	SPL94	STP401	847	26
SPL88	STP367	783	26	SPL94	STP403	850	26
SPL88	STP369	786	26	SPL94	STP405	853	26
SPL88	20-106	790	26	SPL94	STP407	856	26
SPL89	STP371	792	26	SPL94	STP409	859	26
SPL89	STP372	794	26	SPL94	STP411	862	26
SPL89	J4-b5	795	26	SPL94	28-4	864	26
SPL90	STP381	805	26	SPL95	STP398	842	26
SPL90	STP382	807	26	SPL95	STP400	845	26
SPL90	STP383	809	26	SPL95	STP402	848	26
SPL90	STP384	811	26	SPL95	STP404	851	26
SPL90	STP385	813	26	SPL95	STP406	854	26
SPL90	STP386	815	26	SPL95	STP408	857	26
SPL90	STP387	817	26	SPL95	STP410	860	26
SPL90	STP388	819	26	SPL95	STP412	863	26
SPL90	29-4	820	26	SPL95	17-4	865	26



FROM	TO	WIRE ID	WIRE SIZE	FROM	TO	WIRE ID	WIRE SIZE
SPL96	STP413	867	26	SPL102	STP446	924	26
SPL96	STP415	870	26	SPL102	STP447	926	26
SPL96	STP417	873	26	SPL102	STP448	928	26
SPL96	STP419	876	26	SPL102	STP449	930	26
SPL96	STP421	879	26	SPL102	STP450	932	26
SPL96	STP423	882	26	SPL102	17-106	934	26
SPL96	STP425	885	26	SPL103	STP451	935	26
SPL96	STP427	888	26	SPL103	STP452	937	26
SPL96	32-4	890	26	SPL103	STP453	939	26
SPL97	STP414	868	26	SPL103	STP454	941	26
SPL97	STP416	871	26	SPL103	STP455	943	26
SPL97	STP418	874	26	SPL103	STP456	945	26
SPL97	STP420	877	26	SPL103	STP457	947	26
SPL97	STP422	880	26	SPL103	STP458	949	26
SPL97	STP424	883	26	SPL103	10-106	951	26
SPL97	STP426	806	26	SPL104	STP451	936	26
SPL97	STP428	889	26	SPL104	STP452	938	26
SPL97	20-4	891	26	SPL104	STP453	940	26
SPL98	STP429	893	26	SPL104	STP454	942	26
SPL98	STP431	896	26	SPL104	STP455	944	26
SPL98	STP433	899	26	SPL104	STP455	946	26
SPL98	STP435	902	26	SPL104	STP457	947	26
SPL98	32-4	904	26	SPL104	STP458	950	26
SPL99	STP430	894	26	SPL104	5-106	952	26
SPL99	STP432	897	26	SPL105	STP460	954	26
SPL99	STP434	900	26	SPL105	STP462	957	26
SPL99	STP436	903	26	SPL105	STP464	960	26
SPL99	20-4	905	26	SPL105	STP466	963	26
SPL100	STP437	907	26	SPL105	STP468	966	26
SPL100	STP438	909	26	SPL105	STP470	969	26
SPL100	STP439	911	26	SPL105	STP472	972	26
SPL100	STP440	913	26	SPL105	STP474	975	26
SPL100	STP442	916	26	SPL105	26-4	977	26
SPL100	STP443	918	26	SPL106	STP459	955	26
SPL100	STP444	920	26	SPL106	STP461	958	26
SPL100	22-25	922	26	SPL106	STP463	961	26
SPL101	STP437	906	26	SPL106	STP465	964	26
SPL101	STP438	908	26	SPL106	STP467	967	26
SPL101	STP439	910	26	SPL106	STP469	970	26
SPL101	STP446	923	26	SPL106	STP471	973	26
SPL101	STP447	925	26	SPL106	STP473	976	26
SPL101	STP448	927	26	SPL106	16-106	978	26
SPL101	STP449	929	26	SPL107	STP475	979	26
SPL101	STP450	931	26	SPL107	STP476	981	26
SPL101	3-106	933	26	SPL107	STP477	983	26

## 3-31. MAJOR TEST ADAPTER (cont)

3-31

FROM	TO	WIRE ID	WIRE SIZE	FROM	TO	WIRE ID	WIRE SIZE
SPL107	STP478	985	26	SPL112	STP508	1357	26
SPL107	STP479	987	26	SPL112	STP509	1359	26
SPL107	STP480	989	26	SPL113	SPL114	1377	26
SPL107	STP481	991	26	SPL113	STP510	1362	26
SPL107	STP482	993	26	SPL113	STP511	1364	26
SPL107	J3-U6	995	26	SPL113	STP512	1366	26
SPL108	STP475	980	26	SPL113	STP513	1368	26
SPL108	STP476	982	26	SPL113	STP514	1370	26
SPL108	STP477	984	26	SPL113	STP515	1372	26
SPL108	STP478	986	26	SPL113	STP516	1374	26
SPL108	STP479	988	26	SPL113	STP517	1375	26
SPL108	STP480	990	26	SPL114	SPL113	1377	26
SPL108	STP481	992	26	SPL114	STP518	1379	26
SPL108	STP482	994	26	SPL114	STP519	1381	26
SPL108	5-106	996	26	SPL114	STP520	1383	26
SPL109	SPL110	1315	26	SPL114	STP521	1385	26
SPL109	STP483	1304	26	SPL114	STP522	1387	26
SPL109	STP484	1306	26	SPL114	STP523	1389	26
SPL109	STP485	1308	26	SPL114	STP524	1391	26
SPL109	STP486	1310	26	SPL115	SPL116	1406	26
SPL109	STP487	1312	26	SPL115	STP525	1393	26
SPL109	STP488	1314	26	SPL115	STP526	1395	26
SPL110	SPL109	1315	26	SPL115	STP527	1397	26
SPL110	SPL150	1328	26	SPL115	STP528	1399	26
SPL110	STP489	1317	26	SPL115	STP529	1401	26
SPL110	STP490	1318	26	SPL115	STP530	1403	26
SPL110	STP491	1321	26	SPL115	STP531	1405	26
SPL110	STP492	1323	26	SPL116	SPL115	1406	26
SPL110	STP493	1325	26	SPL116	SPL117	1419	26
SPL110	STP494	1327	26	SPL116	STP532	1408	26
SPL111	SPL112	1345	26	SPL116	STP533	1410	26
SPL111	STP495	1330	26	SPL116	STP534	1412	26
SPL111	STP496	1332	26	SPL116	STP535	1414	26
SPL111	STP497	1334	26	SPL116	STP536	1416	26
SPL111	STP498	1336	26	SPL116	STP537	1418	26
SPL111	STP499	1338	26	SPL117	SPL116	1419	26
SPL111	STP500	1340	26	SPL117	STP538	1421	26
SPL111	STP501	1342	26	SPL117	STP539	1423	26
SPL111	STP502	1344	26	SPL117	STP540	1425	26
SPL112	SPL111	1345	26	SPL117	STP541	1427	26
SPL112	STP503	1347	26	SPL117	STP543	1429	26
SPL112	STP504	1349	26	SPL117	STP542	1431	26
SPL112	STP505	1351	26	SPL117	STP544	1433	26
SPL112	STP506	1353	26	SPL118	SPL119	1450	26
SPL112	STP507	1355	26	SPL118	STP545	1435	26

3-31. MAJOR TEST ADAPTER (cont)

FROM	TO	WIRE ID	WIRE SIZE	FROM	TO	WIRE ID	WIRE SIZE
SPL118	STP546	1437	26	SPL123	STP585	1519	26
SPL118	STP547	1439	26	SPL123	STP586	1521	26
SPL118	STP548	1441	26	SPL123	STP587	1223	26
SPL118	STP549	1443	26	SPL123	STP588	1525	26
SPL118	STP550	1445	26	SPL123	STP589	1527	26
SPL118	STP551	1447	26	SPL123	STP590	1529	26
SPL118	STP552	1449	26	SPL123	STP591	1531	26
SPL118	STP558	1462	26	SPL123	STP592	1533	26
SPL119	SPL118	1450	26	SPL124	SPL123	1534	26
SPL119	STP553	1452	26	SPL124	SPL125	1549	26
SPL119	STP554	1454	26	SPL124	STP593	1536	26
SPL119	STP554	1464	26	SPL124	STP594	1538	26
SPL119	STP555	1456	26	SPL124	STP595	1540	26
SPL119	STP556	1458	26	SPL124	STP596	1542	26
SPL119	STP557	1460	26	SPL124	STP597	1544	26
SPL119	STP560	1466	26	SPL124	STP598	1546	26
SPL119	STP561	1468	26	SPL124	STP599	1548	26
SPL120	STP562	1470	26	SPL125	SPL124	1549	26
SPL120	STP563	1472	26	SPL125	SPL126	1562	26
SPL120	STP564	1474	26	SPL125	STP600	1551	26
SPL120	STP565	1476	26	SPL125	STP601	1553	26
SPL120	STP566	1478	26	SPL125	STP602	1555	26
SPL120	STP567	1480	26	SPL125	STP603	1557	26
SPL121	SPL122	1500	26	SPL125	STP604	1559	26
SPL121	STP568	1482	26	SPL125	STP605	1561	26
SPL121	STP569	1484	26	SPL126	SPL125	1562	26
SPL121	STP570	1486	26	SPL126	SPL127	1575	26
SPL121	STP571	1488	26	SPL126	STP606	1564	26
SPL121	STP572	1490	26	SPL126	STP607	1566	26
SPL121	STP573	1492	26	SPL126	STP608	1568	26
SPL121	STP574	1495	26	SPL126	STP609	1570	26
SPL121	STP575	1497	26	SPL126	STP610	1572	26
SPL121	STP576	1499	26	SPL126	STP611	1574	26
SPL122	SPL121	1500	26	SPL127	SPL126	1575	26
SPL122	SPL123	1517	26	SPL127	SPL128	1588	26
SPL122	STP577	1502	26	SPL127	STP612	1577	26
SPL122	STP578	1504	26	SPL127	STP613	1579	26
SPL122	STP579	1506	26	SPL127	STP614	1581	26
SPL122	STP580	1508	26	SPL127	STP615	1583	26
SPL122	STP581	1510	26	SPL127	STP616	1585	26
SPL122	STP582	1512	26	SPL127	STP617	1587	26
SPL122	STP583	1514	26	SPL128	SPL127	1588	26
SPL122	STP584	1516	26	SPL128	SPL129	1601	26
SPL123	SPL122	1517	26	SPL128	STP618	1590	26
SPL123	SPL124	1534	26	SPL128	STP619	1592	26

## 3-31. MAJOR TEST ADAPTER (cont)

3-31

FROM	TO	WIRE ID	WIRE SIZE	FROM	TO	WIRE ID	WIRE SIZE
SPL128	STP620	1594	26	SPL133	STP656	1671	26
SPL128	STP621	1596	26	SPL133	STP657	1673	26
SPL128	STP622	1598	26	SPL134	SPL133	1673	26
SPL128	STP623	1600	26	SPL134	SPL150	1773	26
SPL129	SPL128	1601	26	SPL134	STP658	1676	26
SPL129	SPL130	1616	26	SPL134	STP659	1678	26
SPL129	STP624	1603	26	SPL134	STP660	1680	26
SPL129	STP625	1605	26	SPL134	STP661	1682	26
SPL129	STP626	1607	26	SPL134	STP662	1684	26
SPL129	STP627	1609	26	SPL134	STP663	1686	26
SPL129	STP628	1611	26	SPL135	SPL136	1699	26
SPL129	STP629	1613	26	SPL135	STP664	1688	26
SPL129	STP630	1615	26	SPL135	STP665	1690	26
SPL130	SPL129	1616	26	SPL135	STP666	1692	26
SPL130	SPL131	1631	26	SPL135	STP667	1694	26
SPL130	STP631	1618	26	SPL135	STP668	1696	26
SPL130	STP632	1620	26	SPL135	STP669	1698	26
SPL130	STP633	1622	26	SPL136	SPL135	1699	26
SPL130	STP634	1624	26	SPL136	SPL150	1712	26
SPL130	STP635	1626	26	SPL136	STP670	1701	26
SPL130	STP636	1628	26	SPL136	STP671	1703	26
SPL130	STP637	1630	26	SPL136	STP672	1705	26
SPL131	SPL130	1631	26	SPL136	STP673	1707	26
SPL131	SPL150	1644	26	SPL136	STP674	1709	26
SPL131	STP638	1633	26	SPL136	STP675	1711	26
SPL131	STP639	1635	26	SPL137	SPL151	1729	26
SPL131	STP640	1637	26	SPL137	STP676	1714	26
SPL131	STP641	2639	26	SPL137	STP677	1716	26
SPL131	STP642	1641	26	SPL137	STP678	1718	26
SPL131	STP643	1643	26	SPL137	STP679	1720	26
SPL132	SPL133	1659	26	SPL137	STP680	1722	26
SPL132	STP644	1646	26	SPL137	STP681	1724	26
SPL132	STP645	1648	26	SPL137	STP682	1726	26
SPL132	STP646	1650	26	SPL137	STP683	1728	26
SPL132	STP647	1652	26	SPL138	SPL139	1744	26
SPL132	STP648	1654	26	SPL138	STP684	1731	26
SPL132	STP649	1656	26	SPL138	STP685	1733	26
SPL132	STP650	1658	26	SPL138	STP686	1735	26
SPL133	SPL132	1659	26	SPL138	STP687	1737	26
SPL133	SPL134	1673	26	SPL138	STP688	1739	26
SPL133	STP651	1661	26	SPL138	STP689	1741	26
SPL133	STP652	1663	26	SPL138	STP690	1743	26
SPL133	STP653	1665	26	SPL139	SPL138	1744	26
SPL133	STP654	1667	26	SPL139	SPL140	1757	26
SPL133	STP655	1669	26	SPL139	STP691	1746	26

## 3-31. MAJOR TEST ADAPTER (cont)

3-31

FROM	TO	WIRE ID	WIRE SIZE	FROM	TO	WIRE ID	WIRE SIZE
SPL139	STP692	1748	26	SPL144	STP728	1826	26
SPL139	STP693	1750	26	SPL144	STP729	1828	26
SPL139	STP694	1752	26	SPL144	STP730	1830	26
SPL139	STP695	1754	26	SPL145	SPL144	1831	26
SPL139	STP696	1756	26	SPL145	SPL146	1846	26
SPL140	SPL139	1757	26	SPL145	STP731	1833	26
SPL140	SPL151	1772	26	SPL145	STP732	1835	26
SPL140	STP698	1761	26	SPL145	STP733	1837	26
SPL140	STP697	1759	26	SPL145	STP734	1839	26
SPL140	STP699	1763	26	SPL145	STP735	1841	26
SPL140	STP700	1765	26	SPL145	STP736	1843	26
SPL140	STP701	1767	26	SPL145	STP737	1845	26
SPL140	STP702	1769	26	SPL146	SPL145	1846	26
SPL140	STP703	1771	26	SPL146	SPL147	1861	26
SPL141	SPL142	2788	26	SPL146	STP738	1848	26
SPL141	STP704	1775	26	SPL146	STP739	1850	26
SPL141	STP705	1777	26	SPL146	STP740	1852	26
SPL141	STP706	1779	26	SPL146	STP741	1854	26
SPL141	STP707	1781	26	SPL146	STP742	1856	26
SPL141	STP708	1783	26	SPL146	STP743	1858	26
SPL141	STP709	1785	26	SPL146	STP744	1860	26
SPL141	STP710	1787	26	SPL147	SPL146	1861	26
SPL142	SPL141	2788	26	SPL147	SPL151	1870	26
SPL142	SPL143	1803	26	SPL147	STP745	1863	26
SPL142	STP711	1790	26	SPL147	STP746	1865	26
SPL142	STP712	1792	26	SPL147	STP747	1867	26
SPL142	STP713	1794	26	SPL147	STP748	1869	26
SPL142	STP714	1796	26	SPL148	SPL149	1887	26
SPL142	STP715	1798	26	SPL148	STP749	1872	26
SPL142	STP716	1800	26	SPL148	STP750	1874	26
SPL142	STP717	1802	26	SPL148	STP751	1876	26
SPL143	SPL142	1803	26	SPL148	STP752	1878	26
SPL143	SPL151	1814	26	SPL148	STP753	1880	26
SPL143	STP718	1805	26	SPL148	STP754	1882	26
SPL143	STP719	1807	26	SPL148	STP755	1884	26
SPL143	STP720	1809	26	SPL148	STP756	1886	26
SPL143	STP721	1811	26	SPL149	J1-H3	1904	26
SPL143	STP722	1813	26	SPL149	SPL148	1887	26
SPL144	SPL145	1831	26	SPL149	SPL151	1902	26
SPL144	STP723	1816	26	SPL149	STP757	1889	26
SPL144	STP724	1818	26	SPL149	STP758	1891	26
SPL144	STP725	1820	26	SPL149	STP759	1893	26
SPL144	STP726	1822	26	SPL149	STP760	1895	26
SPL144	STP727	1824	26	SPL149	STP761	1897	26
				SPL149	STP762	1899	26

## 3-31. MAJOR TEST ADAPTER (cont)

3-31

FROM	TO	WIRE ID	WIRE SIZE	FROM	TO	WIRE ID	WIRE SIZE
SPL149	STP763	1901	26	STP17	OPEN	37	26
SPL150	SPL110	1328	26	STP17	SPL 6	38	26
SPL150	SPL131	1644	26	STP18	OPEN	39	26
SPL150	J1-H1	1903	26	STP18	SPL 6	40	26
SPL150	SPL134	1773	26	STP19	OPEN	41	26
SPL150	SPL136	1712	26	STP19	SPL 6	42	26
SPL151	SPL137	1729	26	STP20	OPEN	43	26
SPL151	SPL140	1772	26	STP20	SPL 6	44	26
SPL151	SPL143	1814	26	STP21	OPEN	45	26
SPL151	SPL147	1870	26	STP21	SPL 6	46	26
SPL151	SPL149	1902	26	STP22	OPEN	47	26
STP1	OPEN	1	26	STP22	SPL 6	48	26
STP1	SPL1	2	26	STP23	OPEN	49	26
STP2	OPEN	3	26	STP23	SPL 6	50	26
STP2	SPL1	4	26	STP24	OPEN	51	26
STP3	OPEN	5	26	STP24	SPL 6	52	26
STP3	SPL1	6	26	STP25	OPEN	55	26
STP4	OPEN	7	26	STP25	SPL 8	56	26
STP4	SPL1	8	26	STP26	OPEN	57	26
STP5	OPEN	9	26	STP26	SPL 8	58	26
STP5	SPL1	10	26	STP27	OPEN	59	26
STP6	OPEN	11	26	STP27	SPL 8	60	26
STP6	SPL1	12	26	STP28	OPEN	61	26
STP7	OPEN	13	26	STP28	SPL 8	62	26
STP7	SPL1	14	26	STP29	OPEN	63	26
STP8	OPEN	15	26	STP29	SPL 8	64	26
STP8	SPL1	16	26	STP30	OPEN	65	26
STP9	OPEN	19	26	STP30	SPL 8	66	26
STP9	SPL 4	20	26	STP31	OPEN	67	26
STP10	OPEN	21	26	STP31	SPL 8	68	26
STP10	SPL 4	22	26	STP32	OPEN	69	26
STP11	OPEN	23	26	STP32	SPL 8	70	26
STP11	SPL 4	24	26	STP33	OPEN	73	26
STP12	OPEN	25	26	STP33	SPL 10	74	26
STP12	SPL 4	26	26	STP34	OPEN	75	26
STP13	OPEN	27	26	STP34	SPL 10	76	26
STP13	SPL 4	28	26	STP35	OPEN	77	26
STP14	OPEN	29	26	STP35	SPL 10	78	26
STP14	SPL 4	30	26	STP36	OPEN	79	26
STP15	OPEN	31	26	STP36	SPL 10	80	26
STP15	SPL 4	32	26	STP37	OPEN	81	26
STP16	OPEN	33	26	STP37	SPL 10	82	26
STP16	SPL 4	34	26	STP38	OPEN	83	26
				STP38	SPL 10	84	26

## 3-31. MAJOR TEST ADAPTER (cont)

3-31

FROM	TO	WIRE ID	WIRE SIZE	FROM	TO	WIRE ID	WIRE SIZE
STP39	OPEN	85	26	STP61	OPEN	134	26
STP39	SPL10	86	26	STP61	SPL16	135	26
STP40	OPEN	87	26	STP62	OPEN	136	26
STP40	SPL10	87	26	STP62	SPL16	137	26
STP41	OPEN	90	26	STP63	OPEN	138	26
STP41	SPL12	91	26	STP63	SPL16	139	26
STP42	OPEN	92	26	STP64	OPEN	140	26
STP42	SPL12	93	26	STP64	SPL16	141	26
STP43	OPEN	94	26	STP65	OPEN	144	26
STP43	SPL12	95	26	STP65	SPL17	145	26
STP44	OPEN	96	26	STP66	OPEN	146	26
STP44	SPL12	97	26	STP66	SPL17	147	26
STP45	OPEN	98	26	STP67	OPEN	148	26
STP45	SPL12	99	26	STP67	SPL17	149	26
STP46	OPEN	100	26	STP68	OPEN	150	26
STP46	SPL12	101	26	STP68	SPL17	151	26
STP47	OPEN	102	26	STP69	OPEN	152	26
STP47	SPL12	103	26	STP69	SPL17	153	26
STP48	OPEN	104	26	STP70	OPEN	154	26
STP48	SPL12	105	26	STP70	SPL17	155	26
STP49	OPEN	108	26	STP71	OPEN	156	26
STP49	SPL14	109	26	STP71	SPL17	157	26
STP50	OPEN	110	26	STP72	OPEN	158	26
STP50	SPL14	111	26	STP72	SPL17	159	26
STP51	OPEN	112	26	STP73	OPEN	162	26
STP51	SPL14	113	26	STP73	SPL19	163	26
STP52	OPEN	114	26	STP74	OPEN	164	26
STP52	SPL14	115	26	STP74	SPL19	165	26
STP53	OPEN	116	26	STP75	OPEN	167	26
STP53	SPL14	117	26	STP75	SPL22	168	26
STP54	OPEN	118	26	STP76	OPEN	169	26
STP54	SPL14	119	26	STP76	SPL22	170	26
STP55	OPEN	120	26	STP77	OPEN	171	26
STP55	SPL14	121	26	STP77	SPL22	172	26
STP56	OPEN	122	26	STP78	OPEN	173	26
STP56	SPL14	123	26	STP78	SPL22	174	26
STP57	OPEN	126	26	STP79	OPEN	175	26
STP57	SPL16	127	26	STP79	SPL22	176	26
STP58	OPEN	128	26	STP80	OPEN	177	26
STP58	SPL16	129	26	STP80	SPL22	178	26
STP59	OPEN	130	26	STP81	OPEN	181	26
STP59	SPL16	131	26	STP81	SPL23	182	26
STP60	OPEN	132	26	STP82	OPEN	183	26
STP60	SPL16	133	26	STP82	SPL23	184	26

## 3-31. MAJOR TEST ADAPTER (cont)

3-31

FROM	TO	WIRE ID	WIRE SIZE	FROM	TO	WIRE ID	WIRE SIZE
STP83	OPEN	185	26	STP105	OPEN	236	26
STP83	SPL 23	186	26	STP105	SPL 29	237	26
STP84	OPEN	187	26	STP106	OPEN	238	26
STP84	SPL 23	188	26	STP106	SPL 29	239	26
STP85	OPEN	189	26	STP107	OPEN	240	26
STP85	SPL 23	190	26	STP107	SPL 29	241	26
STP86	OPEN	191	26	STP108	OPEN	242	26
STP86	SPL 23	192	26	STP108	SPL 29	243	26
STP87	OPEN	193	26	STP109	OPEN	244	26
STP87	SPL 23	194	26	STP109	SPL 29	245	26
STP88	OPEN	195	26	STP110	OPEN	246	26
STP88	SPL 23	196	26	STP110	SPL 29	247	26
STP89	OPEN	199	26	STP111	OPEN	248	26
STP89	SPL 25	200	26	STP111	SPL 29	249	26
STP90	OPEN	201	26	STP112	OPEN	250	26
STP90	SPL 25	202	26	STP112	SPL 29	251	26
STP91	OPEN	203	26	STP113	OPEN	254	26
STP91	SPL 25	204	26	STP113	SPL 32	255	26
STP92	OPEN	205	26	STP114	OPEN	256	26
STP92	SPL 25	206	26	STP114	SPL 32	257	26
STP93	OPEN	207	26	STP115	OPEN	258	26
STP93	SPL 25	208	26	STP115	SPL 32	259	26
STP94	OPEN	209	26	STP116	OPEN	260	26
STP94	SPL 25	210	26	STP116	SPL 32	261	26
STP95	OPEN	211	26	STP117	OPEN	262	26
STP95	SPL 25	212	26	STP117	SPL 32	263	26
STP96	OPEN	213	26	STP118	OPEN	264	26
STP96	SPL 25	214	26	STP118	SPL 32	265	26
STP97	OPEN	217	26	STP119	OPEN	266	26
STP97	SPL 27	218	26	STP119	SPL 32	267	26
STP98	OPEN	219	26	STP120	OPEN	268	26
STP98	SPL 27	220	26	STP120	SPL 32	269	26
STP99	OPEN	221	26	STP121	OPEN	272	26
STP99	SPL 27	222	26	STP121	SPL 34	273	26
STP100	OPEN	223	26	STP122	OPEN	274	26
STP100	SPL 27	224	26	STP122	SPL 34	275	26
STP101	OPEN	225	26	STP123	OPEN	276	26
STP101	SPL 27	226	26	STP123	SPL 34	277	26
STP102	OPEN	227	26	STP124	OPEN	278	26
STP102	SPL 27	228	26	STP124	SPL 34	279	26
STP103	OPEN	229	26	STP125	OPEN	280	26
STP103	SPL 27	230	26	STP125	SPL 34	281	26
STP104	OPEN	231	26	STP126	OPEN	282	26
STP104	SPL 27	232	26	STP126	SPL 34	283	26



## 3-31. MAJOR TEST ADAPTER (cont)

3-31

FROM	TO	WIRE ID	WIRE SIZE	FROM	TO	WIRE ID	WIRE SIZE
STP127	OPEN	284	26	STP149	SPL41	335	26
STP127	SPL 34	285	26	STP150	SPL42	336	26
STP128	OPEN	286	26	STP150	P1-Y14	334	26
STP128	SPL 34	287	26	STP150	STP149	334	26
STP129	OPEN	289	26	STP151	STP152	337	26
STP129	SPL 36	290	26	STP151	SPL41	338	26
STP130	OPEN	291	26	STP152	SPL42	339	26
STP130	SPL 36	292	26	STP152	P1-Y16	337	26
STP131	OPEN	293	26	STP152	STP151	337	26
STP131	SPL 36	294	26	STP153	STP154	340	26
STP132	OPEN	295	26	STP153	SPL41	341	26
STP132	SPL 36	296	26	STP154	P1-Y16	340	26
STP133	OPEN	297	26	STP154	STP153	340	26
STP133	SPL 36	298	26	STP154	2-106	342	26
STP134	OPEN	299	26	STP155	OPEN	345	26
STP134	SPL 36	300	26	STP155	SPL44	346	26
STP135	OPEN	301	26	STP156	OPEN	347	26
STP135	SPL 36	302	26	STP156	SPL44	348	26
STP136	OPEN	303	26	STP157	OPEN	349	26
STP136	SPL 36	304	26	STP157	SPL44	350	26
STP137	OPEN	308	26	STP158	OPEN	351	26
STP137	SPL 39	309	26	STP158	SPL44	352	26
STP138	OPEN	310	26	STP159	OPEN	353	26
STP138	SPL 39	311	26	STP159	SPL44	354	26
STP139	OPEN	312	26	STP160	OPEN	355	26
STP139	SPL 39	313	26	STP160	SPL44	356	26
STP140	OPEN	314	26	STP161	OPEN	357	26
STP140	SPL 39	315	26	STP161	SPL44	358	26
STP141	OPEN	316	26	STP162	OPEN	359	26
STP141	SPL 39	317	26	STP162	SPL44	360	26
STP142	OPEN	318	26	STP163	STP164	363	26
STP142	SPL 39	319	26	STP163	SPL46	364	26
STP143	OPEN	320	26	STP164	P1-Z15	363	26
STP143	SPL 39	321	26	STP164	STP163	363	26
STP144	OPEN	322	26	STP164	SPL42	365	26
STP144	SPL 39	323	26	STP165	STP166	366	26
STP145	OPEN	326	26	STP166	SPL46	367	26
STP145	SPL41	327	26	STP166	P1-Z15	366	26
STP146	OPEN	328	26	STP166	STP165	366	26
STP146	SPL41	329	26	STP166	29-5	368	26
STP147	OPEN	330	26	STP167	STP168	369	26
STP147	SPL41	331	26	STP167	SPL46	370	26
STP148	OPEN	332	26	STP168	P1-Z17	369	26
STP148	SPL41	333	26	STP168	STP167	369	26
STP149	STP150	334	26	STP168	SPL42	371	26

## 3-31. MAJOR TEST ADAPTER (cont)

3-31

FROM	TO	WIRE ID	WIRE SIZE	FROM	TO	WIRE ID	WIRE SIZE
STP169	STP170	372	26	STP187	SPL48	403	26
STP169	SPL46	373	26	STP187	OPEN	403	26
STP170	P1-Z17	372	26	STP187	SPL49	404	26
STP170	STP169	372	26	STP188	SPL48	405	26
STP170	23-4	374	26	STP188	OPEN	405	26
STP171	STP172	375	26	STP188	SPL49	406	26
STP171	SPL46	376	26	STP189	SPL48	407	26
STP172	P1-Z19	375	26	STP189	OPEN	407	26
STP172	STP171	375	26	STP189	SPL49	408	26
STP172	SPL42	377	26	STP190	SPL48	409	26
STP173	STP174	378	26	STP190	OPEN	409	26
STP173	SPL46	379	26	STP190	SPL49	410	26
STP174	P1-Z19	378	26	STP191	SPL48	411	26
STP174	STP173	378	26	STP191	OPEN	411	26
STP174	16-5	380	26	STP191	SPL49	412	26
STP175	STP176	381	26	STP192	SPL48	413	26
STP175	SPL46	382	26	STP192	OPEN	413	26
STP176	P1-Z22	381	26	STP192	SPL49	414	26
STP176	STP175	381	26	STP193	SPL48	415	26
STP176	SPL42	383	26	STP193	OPEN	415	26
STP177	STP178	384	26	STP193	SPL49	416	26
STP177	SPL46	385	26	STP194	SPL48	417	26
STP178	P1-Z22	384	26	STP194	OPEN	417	26
STP178	STP177	384	26	STP194	SPL49	418	26
STP178	10-5	386	26	STP195	SPL50	421	26
STP179	STP180	388	26	STP195	OPEN	421	26
STP179	SPL47	389	26	STP195	SPL51	422	26
STP180	P1-Z24	388	26	STP196	SPL50	423	26
STP180	STP179	388	26	STP196	OPEN	423	26
STP180	SPL42	390	26	STP196	SPL51	424	26
STP181	STP182	391	26	STP197	SPL50	425	26
STP181	SPL47	392	26	STP197	OPEN	425	26
STP182	P1-Z24	391	26	STP197	SPL51	426	26
STP182	STP181	391	26	STP198	SPL50	427	26
STP182	5-5	393	26	STP198	OPEN	427	26
STP183	STP184	394	26	STP198	SPL51	428	26
STP183	SPL47	395	26	STP199	SPL50	429	26
STP184	P1-Z26	394	26	STP199	OPEN	429	26
STP184	STP183	394	26	STP199	SPL51	430	26
STP184	SPL42	396	26	STP200	SPL50	431	26
STP185	STP186	397	26	STP200	OPEN	431	26
STP185	SPL47	398	26	STP200	SPL51	432	26
STP186	P1-Z26	397	26	STP201	SPL50	433	26
STP186	STP185	397	26	STP201	OPEN	433	26
STP186	SPL43	399	26	STP201	SPL51	434	26

## 3-31. MAJOR TEST ADAPTER (cont)

3-31

FROM	TO	WIRE ID	WIRE SIZE	FROM	TO	WIRE ID	WIRE SIZE
STP202	SPL 50	435	26	STP217	SPL 55	469	26
STP202	OPEN	435	26	STP218	SPL 54	470	26
STP202	SPL 51	436	26	STP218	OPEN	470	26
STP203	STP204	437	26	STP218	SPL 55	471	26
STP203	SPL 50	438	26	STP219	SPL 54	472	26
STP204	STP203	437	26	STP219	OPEN	472	26
STP204	2-106	439	26	STP219	SPL 55	473	26
STP205	SPL 52	442	26	STP220	SPL 54	474	26
STP205	OPEN	442	26	STP220	OPEN	474	26
STP205	SPL 53	443	26	STP220	SPL 55	475	26
STP206	SPL 52	444	26	STP221	SPL 56	478	26
STP206	OPEN	444	26	STP221	OPEN	478	26
STP206	SPL 53	445	26	STP221	SPL 57	479	26
STP207	SPL 52	446	26	STP222	SPL 56	480	26
STP207	OPEN	446	26	STP222	OPEN	480	26
STP207	SPL 53	447	26	STP222	SPL 57	481	26
STP208	SPL 52	448	26	STP223	SPL 56	482	26
STP208	OPEN	448	26	STP223	OPEN	482	26
STP208	SPL 53	449	26	STP223	SPL 57	483	26
STP209	SPL 52	450	26	STP224	SPL 56	484	26
STP209	OPEN	450	26	STP224	OPEN	484	26
STP209	SPL 53	451	26	STP224	SPL 57	485	26
STP210	SPL 52	452	26	STP225	SPL 56	486	26
STP210	OPEN	452	26	STP225	OPEN	486	26
STP210	SPL 53	453	26	STP225	SPL 57	487	26
STP211	SPL 52	454	26	STP226	SPL 56	488	26
STP211	OPEN	454	26	STP226	OPEN	488	26
STP211	SPL 53	455	26	STP226	SPL 57	489	26
STP212	SPL 52	456	26	STP227	SPL 56	490	26
STP212	OPEN	456	26	STP227	OPEN	490	26
STP212	SPL 53	457	26	STP227	SPL 57	491	26
STP213	SPL 54	460	26	STP228	SPL 56	492	26
STP213	OPEN	460	26	STP228	OPEN	492	26
STP213	SPL 55	461	26	STP228	SPL 57	493	26
STP214	SPL 54	462	26	STP229	SPL 58	496	26
STP214	OPEN	462	26	STP229	OPEN	496	26
STP214	SPL 55	463	26	STP229	SPL 59	497	26
STP215	SPL 54	464	26	STP230	SPL 58	498	26
STP215	OPEN	464	26	STP230	OPEN	498	26
STP215	SPL 55	465	26	STP230	SPL 59	499	26
STP216	SPL 54	466	26	STP231	SPL 58	500	26
STP216	OPEN	466	26	STP231	OPEN	500	26
STP216	SPL 55	467	26	STP231	SPL 59	501	26
STP217	SPL 54	468	26	STP232	SPL 58	502	26
STP217	OPEN	468	26	STP232	OPEN	502	26

## 3-31. MAJOR TEST ADAPTER (cont)

3-31

FROM	TO	WIRE ID	WIRE SIZE	FROM	TO	WIRE ID	WIRE SIZE
STP232	SPL 59	503	26	STP247	SPL 63	537	26
STP233	SPL 58	504	26	STP248	SPL 62	538	26
STP233	OPEN	504	26	STP248	OPEN	538	26
STP233	SPL 59	505	26	STP248	SPL 63	539	26
STP234	SPL 58	506	26	STP249	SPL 62	540	26
STP234	OPEN	506	26	STP249	OPEN	540	26
STP234	SPL 59	507	26	STP249	SPL 63	541	26
STP235	SPL 58	508	26	STP250	SPL 62	542	26
STP235	OPEN	508	26	STP250	OPEN	542	26
STP235	SPL 59	509	26	STP250	SPL 63	543	26
STP236	SPL 58	510	26	STP251	SPL 62	544	26
STP236	OPEN	510	26	STP251	OPEN	544	26
STP236	SPL 59	511	26	STP251	SPL 63	545	26
STP237	SPL 60	514	26	STP252	SPL 62	546	26
STP237	OPEN	514	26	STP252	OPEN	546	26
STP237	SPL 61	515	26	STP252	SPL 63	547	26
STP238	SPL 60	516	26	STP253	SPL 64	550	26
STP238	OPEN	516	26	STP253	OPEN	550	26
STP238	SPL 61	517	26	STP253	SPL 65	551	26
STP239	SPL 60	518	26	STP254	SPL 64	552	24
STP239	OPEN	518	26	STP254	OPEN	552	24
STP239	SPL 61	519	26	STP254	SPL 65	553	24
STP240	SPL 60	520	26	STP255	SPL 64	554	24
STP240	OPEN	520	26	STP255	OPEN	554	24
STP240	SPL 61	521	26	STP255	SPL 65	555	24
STP241	SPL 60	522	26	STP256	SPL 64	556	24
STP241	OPEN	522	26	STP256	OPEN	556	24
STP241	SPL 61	523	26	STP256	SPL 65	557	24
STP242	SPL 60	524	26	STP257	SPL 64	558	24
STP242	OPEN	524	26	STP257	OPEN	558	24
STP242	SPL 61	525	26	STP257	SPL 65	559	24
STP243	SPL 60	526	26	STP258	SPL 64	560	26
STP243	OPEN	526	26	STP258	OPEN	560	26
STP243	SPL 61	527	26	STP258	SPL 65	561	26
STP244	SPL 60	528	26	STP259	SPL 64	562	26
STP244	OPEN	528	26	STP259	OPEN	562	26
STP244	SPL 61	529	26	STP259	SPL 65	563	26
STP245	SPL 62	532	26	STP260	SPL 66	566	26
STP245	OPEN	532	26	STP260	OPEN	566	26
STP245	SPL 63	533	26	STP260	SPL 67	567	26
STP246	SPL 62	534	26	STP261	SPL 66	568	26
STP246	OPEN	534	26	STP261	OPEN	568	26
STP246	SPL 63	535	26	STP261	SPL 67	569	26
STP247	SPL 62	536	26	STP262	SPL 66	570	26
STP247	OPEN	536	26	STP262	OPEN	570	26

## 3-31. MAJOR TEST ADAPTER (cont)

3-31

FROM	TO	WIRE ID	WIRE SIZE	FROM	TO	WIRE ID	WIRE SIZE
STP262	SPL 67	571	26	STP278	SPL 70	606	26
STP263	SPL 66	572	26	STP278	OPEN	606	26
STP263	OPEN	572	26	STP278	SPL 72	607	26
STP263	SPL 67	573	26	STP279	SPL 70	608	26
STP264	SPL 66	574	26	STP279	OPEN	608	26
STP264	OPEN	574	26	STP279	SPL 72	609	26
STP264	SPL 67	575	26	STP280	SPL 73	612	26
STP265	SPL 66	576	26	STP280	OPEN	612	26
STP265	OPEN	576	26	STP280	SPL 72	613	26
STP265	SPL 67	577	26	STP281	SPL 73	614	26
STP266	SPL 66	578	26	STP281	OPEN	614	26
STP266	OPEN	578	26	STP281	SPL 72	615	26
STP266	SPL 67	579	26	STP282	SPL 73	616	26
STP267	SPL 66	580	26	STP282	OPEN	616	26
STP267	OPEN	580	26	STP282	SPL 72	617	26
STP267	SPL 67	581	26	STP283	SPL 73	618	26
STP268	SPL 68	584	26	STP283	OPEN	618	26
STP268	OPEN	584	26	STP283	SPL 72	619	26
STP268	SPL 69	585	26	STP284	SPL 73	620	26
STP269	SPL 68	586	26	STP284	OPEN	620	26
STP269	OPEN	586	26	STP284	SPL 72	621	26
STP269	SPL 69	587	26	STP285	SPL 75	624	26
STP270	SPL 68	588	26	STP285	OPEN	624	26
STP270	OPEN	588	26	STP285	SPL 74	625	26
STP270	SPL 69	589	26	STP286	SPL 75	626	26
STP271	SPL 68	590	26	STP286	OPEN	626	26
STP271	OPEN	590	26	STP286	SPL 74	627	26
STP271	SPL 69	591	26	STP287	SPL 75	628	26
STP272	SPL 70	594	26	STP287	OPEN	628	26
STP272	OPEN	594	26	STP287	SPL 74	629	26
STP272	SPL 71	595	26	STP288	SPL 75	630	26
STP273	SPL 70	596	26	STP288	OPEN	630	26
STP273	OPEN	596	26	STP288	SPL 74	631	26
STP273	SPL 71	597	26	STP289	SPL 75	632	26
STP274	SPL 70	598	26	STP289	OPEN	632	26
STP274	OPEN	598	26	STP289	SPL 74	633	26
STP274	SPL 71	599	26	STP290	SPL 75	634	26
STP275	SPL 70	600	26	STP290	OPEN	634	26
STP275	OPEN	600	26	STP290	SPL 74	635	26
STP275	SPL 71	601	26	STP291	SPL 75	636	26
STP276	SPL 70	602	26	STP291	OPEN	637	26
STP276	OPEN	602	26	STP291	SPL 74	638	26
STP276	SPL 71	603	26	STP292	OPEN	638	26
STP277	SPL 70	604	26	STP292	SPL 75	638	26
STP277	OPEN	604	26	STP292	SPL 74	639	26
STP277	SPL 72	605	26	STP293	SPL 77	642	26

## 3-31. MAJOR TEST ADAPTER (cont)

3-31

FROM	TO	WIRE ID	WIRE SIZE	FROM	TO	WIRE ID	WIRE SIZE
STP293	OPEN	642	26	STP312	SPL 79	677	26
STP293	SPL 76	643	26	STP313	STP314	680	26
STP294	SPL 77	644	26	STP313	SPL 80	681	26
STP294	OPEN	644	26	STP314	STP313	680	26
STP294	SPL 76	645	26	STP314	SPL 81	682	26
STP295	SPL 77	646	26	STP 315	STP316	683	26
STP295	OPEN	646	26	STP315	SPL 80	684	26
STP295	SPL 76	647	26	STP 316	STP315	683	26
STP296	SPL 77	648	26	STP316	SPL 81	685	26
STP296	OPEN	648	26	STP 317	STP318	686	26
STP296	SPL 76	649	26	STP317	SPL 80	687	26
STP297	SPL 77	650	26	STP318	STP317	686	26
STP297	OPEN	650	26	STP318	SPL 81	688	26
STP297	SPL 76	651	26	STP319	STP320	689	26
STP298	SPL 77	652	26	STP319	SPL 80	690	26
STP298	OPEN	652	26	STP 320	STP319	689	26
STP298	SPL 76	653	26	STP320	SPL 81	691	26
STP299	SPL 77	654	26	STP 321	STP322	692	26
STP299	OPEN	654	26	STP321	SPL 80	693	26
STP299	SPL 76	655	26	STP322	STP321	692	26
STP300	SPL 77	656	26	STP322	SPL 81	694	26
STP300	OPEN	656	26	STP323	STP324	695	26
STP300	SPL 76	657	26	STP323	SPL 80	696	26
STP 301	STP302	660	26	STP324	STP323	695	26
STP301	SPL 78	661	26	STP324	SPL 81	697	26
STP302	STP301	660	26	STP325	STP326	698	26
STP302	SPL 79	662	26	STP325	SPL 80	699	26
STP 303	STP 304	663	26	STP326	STP325	698	26
STP303	SPL 78	664	26	STP326	SPL 81	700	26
STP304	STP303	663	26	STP327	STP328	701	26
STP304	SPL 79	665	26	STP327	SPL 80	702	26
STP305	STP306	666	26	STP328	STP327	701	26
STP305	SPL 78	667	26	STP328	J2-E2	703	26
STP306	STP305	666	26	STP329	STP330	706	26
STP306	SPL 79	668	26	STP329	SPL 82	707	26
STP307	STP308	669	26	STP330	SPL 329	706	26
STP307	SPL 78	670	26	STP330	SPL 83	708	26
STP308	STP307	669	26	STP331	STP332	709	26
STP308	SPL 79	671	26	STP331	SPL 82	710	26
STP309	STP310	672	26	STP332	STP331	709	26
STP309	SPL 78	673	26	STP332	SPL 83	711	26
STP310	STP309	672	26	STP333	STP334	712	26
STP310	SPL 79	674	26	STP333	SPL 82	713	26
STP311	STP312	675	26	STP334	STP333	712	26
STP311	SPL 78	676	26	STP344	SPL 83	714	26
STP312	STP311	675	26	STP335	STP336	715	26

3-31. MAJOR TEST ADAPTER (cont)

FROM	TO	WIRE ID	WIRE SIZE	FROM	TO	WIRE ID	WIRE SIZE
STP335	SPL82	716	26	STP359	OPEN	759	26
STP336	STP335	715	26	STP359	SPL85	760	26
STP336	SPL83	717	26	STP360	OPEN	761	26
STP337	STP338	718	26	STP360	SPL85	762	26
STP337	SPL82	719	26	STP361	OPEN	764	26
STP337	STP337	718	26	STP361	SPL86	765	26
STP338	SPL83	720	26	STP362	OPEN	766	26
STP339	STP340	721	26	STP362	SPL86	767	26
STP339	SPL82	722	26	STP363	OPEN	768	26
STP340	STP339	721	26	STP363	SPL86	769	26
STP340	SPL83	723	26	STP364	OPEN	770	26
STP341	STP342	724	26	STP364	SPL86	771	26
STP341	SPL82	725	26	STP365	OPEN	779	26
STP342	SPL83	726	26	STP365	SPL87	780	26
STP342	STP341	724	26	STP366	STP367	781	26
STP343	STP344	727	26	STP366	SPL87	782	26
STP343	SPL82	728	26	STP367	STP366	781	26
STP344	STP343	727	26	STP367	SPL88	783	26
STP344	SPL83	729	26	STP368	STP369	784	26
STP345	OPEN	732	26	STP368	SPL87	785	26
STP345	SPL84	733	26	STP369	SPL368	784	26
STP346	OPEN	734	26	STP369	SPL88	786	26
STP346	SPL84	735	26	STP370	OPEN	787	26
STP347	OPEN	736	26	STP370	SPL87	788	26
STP347	SPL84	737	26	STP371	OPEN	791	26
STP348	OPEN	738	26	STP371	SPL89	792	26
STP348	SPL84	739	26	STP372	OPEN	793	26
STP349	STP350	740	26	STP372	SPL89	794	26
STP349	SPL84	741	26	STP373	J-5	796	COAX
STP350	STP349	740	26	STP373	32-7	796	COAX
STP350	31-93	742	26	STP374	J-6	797	COAX
STP351	STP352	743	26	STP374	28-9	797	COAX
STP351	SPL84	744	26	STP375	J-7	798	COAX
STP352	STP351	743	26	STP375	32-9	798	COAX
STP352	31-93	745	26	STP376	J-8	799	COAX
STP353	OPEN	747	26	STP376	28-11	799	COAX
STP353	SPL85	748	26	STP377	J-9	800	COAX
STP354	OPEN	749	26	STP377	32-11	800	COAX
STP354	SPL85	750	26	STP378	J-10	801	COAX
STP355	OPEN	751	26	STP378	28-13	801	COAX
STP355	SPL85	752	26	STP379	J-11	802	COAX
STP356	OPEN	753	26	STP379	32-13	802	COAX
STP356	SPL85	754	26	STP380	J-12	803	COAX
STP357	OPEN	755	26				
STP357	SPL85	756	26				
STP358	OPEN	757	26				
STP358	SPL85	758	26				

## 3-31. MAJOR TEST ADAPTER (cont)

3-31

FROM	TO	WIRE ID	WIRE SIZE	FROM	TO	WIRE ID	WIRE SIZE
STP380	28-15	803	COAX	STP396	OPEN	836	26
STP381	SPL91	804	26	STP396	SPL92	837	26
STP381	OPEN	804	26	STP397	STP398	840	26
STP381	SPL90	805	26	STP397	SPL94	841	26
STP382	SPL91	806	26	STP398	STP397	840	26
STP382	OPEN	806	26	STP398	SPL95	842	26
STP382	SPL90	807	26	STP399	STP400	843	26
STP383	SPL91	808	26	STP399	SPL94	844	26
STP383	OPEN	808	26	STP400	STP399	843	26
STP383	SPL90	809	26	STP400	SPL95	845	26
STP384	SPL91	810	26	STP401	STP402	846	26
STP384	OPEN	810	26	STP401	SPL94	847	26
STP384	SPL90	811	26	STP402	STP401	846	26
STP385	SPL91	812	26	STP402	SPL95	848	26
STP385	OPEN	812	26	STP403	STP404	849	26
STP385	SPL90	813	26	STP403	SPL94	850	26
STP386	SPL91	814	26	STP404	SPL95	851	26
STP386	OPEN	814	26	STP404	STP403	849	26
STP386	SPL90	815	26	STP405	STP406	852	26
STP387	SPL91	816	26	STP405	SPL94	853	26
STP387	OPEN	816	26	STP406	STP405	852	26
STP387	SPL90	817	26	STP406	SPL95	854	26
STP388	SPL91	818	26	STP407	STP408	855	26
STP388	OPEN	818	26	STP407	SPL94	856	26
STP388	SPL90	819	26	STP408	STP407	855	26
STP389	SPL93	822	26	STP408	SPL95	857	26
STP389	OPEN	822	26	STP409	STP410	858	26
STP389	SPL92	823	26	STP409	SPL94	859	26
STP390	SPL93	824	26	STP410	STP409	858	26
STP390	OPEN	824	26	STP410	SPL95	860	26
STP390	SPL92	825	26	STP411	STP412	861	26
STP391	SPL93	826	26	STP411	SPL94	862	26
STP391	OPEN	826	26	STP412	STP411	861	26
STP391	SPL92	827	26	STP412	SPL95	863	26
STP392	SPL93	828	26	STP413	STP414	866	26
STP392	OPEN	828	26	STP413	SPL96	867	26
STP392	SPL92	829	26	STP414	STP413	866	26
STP393	SPL93	830	26	STP414	SPL97	868	26
STP393	OPEN	830	26	STP415	STP416	869	26
STP393	SPL92	831	26	STP415	SPL96	870	26
STP394	SPL93	832	26	STP416	STP415	869	26
STP394	OPEN	832	26	STP416	SPL97	871	26
STP394	SPL92	833	26	STP417	STP418	872	26
STP395	SPL93	834	26	STP417	SPL96	873	26
STP395	OPEN	834	26	STP418	STP417	872	26
STP395	SPL92	835	26	STP418	SPL97	874	26
STP396	SPL93	836	26				



## 3-31. MAJOR TEST ADAPTER (cont)

3-31

FROM	TO	WIRE ID	WIRE SIZE	FROM	TO	WIRE ID	WIRE SIZE
STP419	STP420	875	26	STP440	STP441	912	26
STP419	SPL96	876	26	STP440	SPL100	913	26
STP420	STP419	875	26	STP441	26-5	914	26
STP420	SPL97	877	26	STP441	STP440	914	26
STP421	STP422	878	26	STP442	OPEN	915	26
STP421	SPL96	879	26	STP442	SPL100	916	26
STP422	STP421	878	26	STP443	OPEN	917	26
STP422	SPL97	880	26	STP443	SPL100	918	26
STP423	STP424	881	26	STP444	STP445	919	26
STP423	SPL96	882	26	STP444	SPL100	920	26
STP424	STP423	881	26	STP445	26-5	921	26
STP424	SPL97	883	26	STP445	STP444	919	26
STP425	STP426	884	26	STP446	SPL101	923	26
STP425	SPL96	885	26	STP446	OPEN	923	26
STP426	STP425	884	26	STP446	SPL102	924	26
STP426	SPL97	886	26	STP447	SPL101	925	26
STP427	STP428	887	26	STP447	OPEN	925	26
STP427	SPL96	888	26	STP447	SPL102	926	26
STP428	STP427	887	26	STP448	SPL101	927	26
STP428	SPL97	889	26	STP448	OPEN	927	26
STP429	STP430	892	26	STP448	SPL102	928	26
STP429	SPL98	893	26	STP449	SPL101	929	26
STP430	STP429	892	26	STP449	OPEN	929	26
STP430	SPL99	894	26	STP449	SPL102	930	26
STP431	STP432	895	26	STP450	SPL101	931	26
STP431	SPL98	896	26	STP450	OPEN	931	26
STP432	STP431	895	26	STP450	SPL102	932	26
STP432	SPL99	897	26	STP451	SPL103	935	26
STP433	STP434	898	26	STP451	OPEN	935	26
STP433	SPL98	899	26	STP451	SPL104	936	26
STP434	STP433	899	26	STP452	SPL103	937	26
STP434	STP433	900	26	STP452	OPEN	937	26
STP434	SPL99	900	26	STP452	SPL104	938	26
STP435	STP436	901	26	STP453	SPL103	939	26
STP435	STP4	901	26	STP453	OPEN	939	26
STP435	SPL98	902	26	STP453	SPL104	940	26
STP436	SPL99	903	26	STP454	SPL103	941	26
STP436	STP435	901	26	STP454	OPEN	941	26
STP437	SPL101	906	26	STP454	SPL104	942	26
STP437	OPEN	906	26	STP455	SPL103	943	26
STP437	SPL100	907	26	STP455	OPEN	943	26
STP438	SPL101	908	26	STP455	SPL104	944	26
STP438	OPEN	908	26	STP456	SPL103	945	26
STP438	SPL100	909	26	STP456	OPEN	945	26
STP439	SPL101	910	26	STP456	SPL104	946	26
STP439	OPEN	910	26	STP457	SPL103	947	26
STP439	SPL100	911	26	STP457	OPEN	947	26

## 3-31. MAJOR TEST ADAPTER (cont)

3-31

FROM	TO	WIRE ID	WIRE SIZE	FROM	TO	WIRE ID	WIRE SIZE
STP457	SPL104	948	26	STP476	SPL107	981	26
STP458	SPL103	949	26	STP476	OPEN	981	26
STP458	OPEN	949	26	STP476	SPL108	982	26
STP458	SPL104	950	26	STP477	SPL107	983	26
STP459	SPL106	955	26	STP477	OPEN	983	26
STP459	23-8	953	26	STP477	SPL108	984	26
STP459	STP460	953	26	STP478	SPL107	985	26
STP460	STP459	953	26	STP478	OPEN	985	26
STP460	SPL105	954	26	STP478	SPL108	986	26
STP461	22-9	956	26	STP479	SPL107	986	26
STP461	STP462	956	26	STP479	OPEN	987	26
STP461	SPL106	958	26	STP479	SPL108	988	26
STP462	STP461	956	26	STP480	SPL107	989	26
STP462	SPL105	957	26	STP480	OPEN	989	26
STP463	SPL106	961	26	STP480	SPL108	990	26
STP463	23-10	959	26	STP481	SPL107	991	26
STP463	STP464	959	26	STP481	OPEN	991	26
STP464	STP463	959	26	STP481	SPL108	992	26
STP464	SPL105	960	26	STP482	SPL107	993	26
STP465	22-11	962	26	STP482	OPEN	993	26
STP465	SPL106	964	26	STP482	SPL108	994	26
STP465	STP466	962	26	STP483	OPEN	1303	26
STP466	STP465	962	26	STP483	SPL109	1304	26
STP466	SPL105	963	26	STP484	OPEN	1305	26
STP467	23-14	965	26	STP484	SPL109	1306	26
STP467	SPL106	967	26	STP485	OPEN	1307	26
STP467	STP468	965	26	STP485	SPL109	1308	26
STP468	STP467	965	26	STP486	OPEN	1309	26
STP468	SPL105	966	26	STP486	SPL109	1310	26
STP469	SPL106	970	26	STP487	OPEN	1311	26
STP469	22-15	968	26	STP487	SPL109	1312	26
STP469	STP470	968	26	STP488	OPEN	1313	26
STP470	STP469	968	26	STP488	SPL109	1314	26
STP470	SPL105	969	26	STP489	OPEN	1316	26
STP471	SPL106	973	26	STP489	SPL110	1317	26
STP471	23-16	971	26	STP490	OPEN	1318	26
STP471	STP472	972	26	STP490	SPL110	1318	26
STP472	STP471	971	26	STP491	OPEN	1320	26
STP472	SPL105	972	26	STP491	SPL110	1321	26
STP473	SPL106	976	26	STP492	OPEN	1322	26
STP473	22-17	974	26	STP492	SPL110	1323	26
STP473	STP474	974	26	STP493	OPEN	1324	26
STP474	STP473	974	26	STP493	SPL110	1325	26
STP474	SPL105	975	26	STP494	OPEN	1326	26
STP475	SPL107	979	26	STP494	SPL110	1327	26
STP475	OPEN	979	26	STP495	OPEN	1329	26
STP475	SPL108	980	26	STP495	P1-S22	1329	26

## 3-31. MAJOR TEST ADAPTER (cont)

FROM	TO	WIRE ID	WIRE SIZE	FROM	TO	WIRE ID	WIRE SIZE
STP495	SPL111	1330	26	STP511	P1-P16	1363	26
STP496	OPEN	1331	26	STP511	SPL113	1364	26
STP496	P1-S24	1331	26	STP512	OPEN	1365	26
STP496	SPL111	1332	26	STP512	P1-P18	1365	26
STP497	OPEN	1333	26	STP512	SPL113	1366	26
STP497	P1-S26	1333	26	STP513	OPEN	1367	26
STP497	SPL111	1334	26	STP513	P1-P21	1367	26
STP498	OPEN	1335	26	STP513	SPL113	1368	26
STP498	P1-R14	1335	26	STP514	OPEN	1369	26
STP498	SPL111	1336	26	STP514	P1-P23	1369	26
STP499	OPEN	1337	26	STP514	SPL113	1370	26
STP499	P1-R16	1337	26	STP515	OPEN	1371	26
STP499	SPL111	1338	26	STP515	P1-P25	1371	26
STP500	OPEN	1339	26	STP515	SPL113	1372	26
STP500	P1-R18	1339	26	STP516	OPEN	1373	26
STP500	SPL111	1340	26	STP516	P1-N15	1373	26
STP501	OPEN	1341	26	STP516	SPL113	1374	26
STP501	P1-R21	1341	26	STP517	OPEN	1375	26
STP501	SPL111	1342	26	STP517	P1-N17	1375	26
STP502	OPEN	1343	26	STP517	SPL113	1375	26
STP502	P1-R23	1343	26	STP518	OPEN	1378	26
STP502	SPL111	1344	26	STP518	P1-N19	1378	26
STP503	OPEN	1346	26	STP518	SPL114	1379	26
STP503	P1-R25	1346	26	STP519	OPEN	1380	26
STP503	SPL112	1347	26	STP519	P1-N22	1380	26
STP504	OPEN	1348	26	STP519	SPL114	1381	26
STP504	P1-Q15	1348	26	STP520	OPEN	1382	26
STP504	SPL112	1349	26	STP520	P1-N24	1382	26
STP505	OPEN	1350	26	STP520	SPL114	1383	26
STP505	P1-Q17	1350	26	STP521	OPEN	1384	26
STP505	SPL112	1351	26	STP521	P1-N26	1384	26
STP506	OPEN	1352	26	STP521	SPL114	1385	26
STP506	P1-Q19	1352	26	STP522	OPEN	1386	26
STP506	SPL112	1353	26	STP522	P1-M14	1386	26
STP507	OPEN	1354	26	STP522	SPL114	1387	26
STP507	P1-Q22	1354	26	STP523	OPEN	1388	26
STP507	SPL112	1355	26	STP523	P1-M16	1388	26
STP508	OPEN	1356	26	STP523	SPL114	1389	26
STP508	P1-Q24	1356	26	STP524	OPEN	1390	26
STP508	SPL112	1357	26	STP524	P1-M18	1390	26
STP509	OPEN	1358	26	STP524	SPL114	1391	26
STP509	P1-Q26	1358	26	STP525	OPEN	1392	26
STP509	SPL112	1359	26	STP525	P1-L22	1392	26
STP510	OPEN	1361	26	STP525	SPL115	1393	26
STP510	P1-P14	1361	26	STP526	OPEN	1394	26
STP510	SPL113	1362	26	STP526	P1-L24	1394	26
STP511	OPEN	1363	26	STP526	SPL115	1395	26
				STP527	OPEN	1396	26

## 3-31. MAJOR TEST ADAPTER (cont)

3-31

FROM	TO	WIRE ID	WIRE SIZE	FROM	TO	WIRE ID	WIRE SIZE
STP527	P1-L26	1396	26	STP543	OPEN	1430	26
STP527	SPL115	1397	26	STP543	OPEN	1535	26
STP528	OPEN	1398	26	STP543	P1-H21	1430	26
STP528	P1-K14	1398	26	STP543	SPL117	1429	26
STP528	SPL115	1399	26	STP544	OPEN	1432	26
STP529	OPEN	1400	26	STP544	P1-H23	1432	26
STP529	P1-K16	1400	26	STP544	SPL117	1433	26
STP529	SPL115	1401	26	STP545	OPEN	1434	26
STP530	OPEN	1402	26	STP545	P1-H25	1434	26
STP530	P1-K18	1402	26	STP545	SPL118	1435	26
STP530	SPL115	1403	26	STP546	OPEN	1436	26
STP531	OPEN	1404	26	STP546	P1-G15	1436	26
STP531	P1-K21	1404	26	STP546	SPL118	1437	26
STP531	SPL115	1405	26	STP547	OPEN	1438	26
STP532	OPEN	1407	26	STP547	P1-G17	1438	26
STP532	P1-K23	1407	26	STP547	SPL118	1439	26
STP532	SPL116	1408	26	STP548	OPEN	1440	26
STP533	OPEN	1409	26	STP548	P1-G19	1440	26
STP533	P1-K25	1409	26	STP548	SPL118	1441	26
STP533	SPL116	1410	26	STP549	OPEN	1442	26
STP534	OPEN	1411	26	STP549	P1-G22	1442	26
STP534	P1-J15	1411	26	STP549	SPL118	1443	26
STP534	SPL116	1412	26	STP550	OPEN	1444	26
STP535	OPEN	1413	26	STP550	P1-G24	1444	26
STP535	P1-J17	1413	26	STP550	SPL118	1445	26
STP535	SPL116	1414	26	STP551	OPEN	1446	26
STP536	OPEN	1415	26	STP551	P1-G26	1446	26
STP536	P1-J19	1415	26	STP551	SPL118	1447	26
STP536	SPL116	1416	26	STP552	OPEN	1448	26
STP537	OPEN	1417	26	STP552	P1-E14	1448	26
STP537	P1-J22	1417	26	STP552	SPL118	1449	26
STP537	SPL116	1418	26	STP553	OPEN	1452	26
STP538	OPEN	1420	26	STP553	P1-E16	1451	26
STP538	P1-J24	1420	26	STP553	SPL119	1452	26
STP538	SPL117	1421	26	STP554	OPEN	1453	26
STP539	OPEN	1422	26	STP554	P1-E18	1453	26
STP539	P1-J26	1422	26	STP554	SPL119	1454	26
STP539	SPL117	1423	26	STP554	SPL119	1464	26
STP540	OPEN	1424	26	STP555	OPEN	1455	26
STP540	P1-H14	1424	26	STP555	P1-E21	1455	26
STP540	SPL117	1425	26	STP555	SPL119	1456	26
STP541	OPEN	1426	26	STP556	OPEN	1457	26
STP541	P1-H16	1426	26	STP556	P1-E23	1457	26
STP541	SPL117	1427	26	STP556	SPL119	1458	26
STP542	OPEN	1428	26	STP557	OPEN	1459	26
STP542	P1-H18	1428	26	STP557	P1-E25	1459	26
STP542	SPL117	1431	26	STP557	SPL119	1460	26

## 3-31. MAJOR TEST ADAPTER (cont)

3-31

FROM	TO	WIRE ID	WIRE SIZE	FROM	TO	WIRE ID	WIRE SIZE
STP558	OPEN	1461	26	STP574	OPEN	1494	26
STP558	P1-D15	1461	26	STP574	P1-C23	1494	26
STP558	SPL118	1462	26	STP574	SPL121	1495	26
STP559	OPEN	1463	26	STP575	OPEN	1496	26
STP559	P1-D17	1463	26	STP575	P1-C25	1496	26
STP560	OPEN	1465	26	STP575	SPL121	1497	26
STP560	P1-D19	1465	26	STP576	OPEN	1498	26
STP560	SPL119	1466	26	STP576	P1-B15	1498	26
STP561	OPEN	1467	26	STP576	SPL121	1499	26
STP561	P1-D22	1467	26	STP577	OPEN	1501	26
STP561	SPL119	1468	26	STP577	P1-B17	1501	26
STP562	OPEN	1469	26	STP577	SPL122	1502	26
STP562	P1-M21	1469	26	STP578	OPEN	1503	26
STP562	SPL120	1470	26	STP578	P1-B19	1503	26
STP563	OPEN	1471	26	STP578	SPL122	1504	26
STP563	P1-M23	1471	26	STP579	OPEN	1505	26
STP563	SPL120	1472	26	STP579	P1-B22	1505	26
STP564	OPEN	1473	26	STP579	SPL122	1506	26
STP564	P1-M25	1473	26	STP580	OPEN	1507	26
STP564	SPL120	1474	26	STP580	P1-B24	1507	26
STP565	OPEN	1475	26	STP580	SPL122	1508	26
STP565	P1-L15	1475	26	STP581	OPEN	1509	26
STP565	SPL120	1476	26	STP581	P1-B26	1509	26
STP566	OPEN	1477	26	STP581	SPL122	1510	26
STP566	P1-L17	1477	26	STP582	OPEN	1511	26
STP566	SPL120	1478	26	STP582	P1-A14	1511	26
STP567	OPEN	1479	26	STP582	SPL122	1512	26
STP567	P1-L19	1479	26	STP583	OPEN	1513	26
STP567	SPL120	1480	26	STP583	P1-A16	1513	26
STP568	OPEN	1481	26	STP583	SPL122	1514	26
STP568	P1-D24	1481	26	STP584	OPEN	1515	26
STP568	SPL121	1482	26	STP584	P1-S19	1515	26
STP569	OPEN	1483	26	STP584	SPL122	1516	26
STP569	P1-D26	1483	26	STP585	OPEN	1518	26
STP569	SPL121	1484	26	STP585	SPL123	1519	26
STP570	OPEN	1485	26	STP586	OPEN	1520	26
STP570	P1-C14	1485	26	STP586	SPL123	1521	26
STP570	SPL121	1486	26	STP587	OPEN	1522	26
STP571	OPEN	1487	26	STP587	SPL123	1523	26
STP571	P1-C16	1487	26	STP588	OPEN	1524	26
STP571	SPL121	1488	26	STP588	SPL123	1525	26
STP572	OPEN	1489	26	STP589	OPEN	1526	26
STP572	P1-C18	1489	26	STP589	SPL123	1527	26
STP572	SPL121	1490	26	STP590	OPEN	1528	26
STP573	OPEN	1491	26	STP590	SPL123	1529	26
STP573	P1-C21	1491	26	STP591	OPEN	1530	26
STP573	SPL121	1492	26	STP591	SPL123	1531	26

## 3-31. MAJOR TEST ADAPTER (cont)

3-31

FROM	TO	WIRE ID	WIRE SIZE	FROM	TO	WIRE ID	WIRE SIZE
STP592	OPEN	1532	26	STP616	OPEN	1584	26
STP592	SPL123	1533	26	STP616	SPL127	1585	26
STP593	SPL124	1536	26	STP617	OPEN	1586	26
STP594	OPEN	1537	26	STP617	SPL127	1587	26
STP594	SPL124	1538	26	STP618	OPEN	1589	26
STP595	OPEN	1539	26	STP618	SPL128	1590	26
STP595	SPL124	1540	26	STP619	OPEN	1591	26
STP596	OPEN	1541	26	STP619	SPL128	1592	26
STP596	SPL124	1542	26	STP620	OPEN	1593	26
STP597	OPEN	1543	26	STP620	SPL128	1594	26
STP597	SPL124	1544	26	STP621	OPEN	1595	26
STP598	OPEN	1545	26	STP621	SPL128	1596	26
STP598	SPL124	1546	26	STP622	OPEN	1597	26
STP599	OPEN	1547	26	STP622	SPL128	1598	26
STP599	SPL124	1548	26	STP623	OPEN	1599	26
STP600	OPEN	1550	26	STP623	SPL128	1600	26
STP600	SPL125	1551	26	STP624	OPEN	1602	26
STP601	OPEN	1552	26	STP624	SPL129	1603	26
STP601	SPL125	1553	26	STP625	OPEN	1604	26
STP602	OPEN	1554	26	STP625	SPL129	1605	26
STP602	SPL125	1555	26	STP626	OPEN	1606	26
STP603	OPEN	1556	26	STP626	SPL129	1607	26
STP603	SPL125	1557	26	STP627	OPEN	1608	26
STP604	OPEN	1558	26	STP627	SPL129	1609	26
STP604	SPL125	1559	26	STP628	OPEN	1610	26
STP605	OPEN	1560	26	STP628	SPL129	1611	26
STP605	SPL125	1561	26	STP629	OPEN	1612	26
STP606	OPEN	1563	26	STP629	SPL129	1613	26
STP606	SPL126	1564	26	STP630	OPEN	1614	26
STP607	OPEN	1565	26	STP630	SPL129	1615	26
STP607	SPL126	1566	26	STP631	OPEN	1617	26
STP608	OPEN	1567	26	STP631	SPL130	1618	26
STP608	SPL126	1568	26	STP632	OPEN	1619	26
STP609	OPEN	1569	26	STP632	SPL130	1620	26
STP609	SPL126	1570	26	STP633	OPEN	1621	26
STP610	OPEN	1571	26	STP633	SPL130	1622	26
STP610	SPL126	1572	26	STP634	OPEN	1623	26
STP611	OPEN	1573	26	STP634	SPL130	1624	26
STP611	SPL126	1574	26	STP635	OPEN	1625	26
STP612	OPEN	1576	26	STP635	SPL130	1626	26
STP612	SPL127	1577	26	STP636	OPEN	1627	26
STP613	OPEN	1578	26	STP636	SPL130	1628	26
STP613	SPL124	1579	26	STP637	OPEN	1629	26
STP614	OPEN	1580	26	STP637	SPL130	1630	26
STP614	SPL127	1581	26	STP638	OPEN	1632	26
STP615	OPEN	1582	26	STP638	SPL131	1633	26
STP615	SPL127	1583	26	STP639	OPEN	1634	26

## 3-31. MAJOR TEST ADAPTER (cont)

3-31

FROM	TO	WIRE ID	WIRE SIZE	FROM	TO	WIRE ID	WIRE SIZE
STP639	SPL131	1635	26	STP663	OPEN	1685	26
STP640	OPEN	1636	26	STP663	SPL134	1686	26
STP640	SPL131	1637	26	STP664	OPEN	1687	26
STP641	OPEN	1638	26	STP664	SPL135	1688	26
STP641	SPL131	1639	26	STP665	OPEN	1689	26
STP642	OPEN	1640	26	STP665	SPL135	1690	26
STP642	SPL131	1641	26	STP666	OPEN	1691	26
STP643	OPEN	1642	26	STP666	SPL135	1692	26
STP643	SPL131	1643	26	STP667	OPEN	1693	26
STP644	OPEN	1645	26	STP667	SPL135	1694	26
STP644	SPL132	1646	26	STP668	OPEN	1695	26
STP645	OPEN	1647	26	STP668	SPL135	1696	26
STP645	SPL132	1648	26	STP669	OPEN	1697	26
STP646	OPEN	1649	26	STP669	SPL135	1698	26
STP646	SPL132	1650	26	STP670	OPEN	1700	26
STP647	OPEN	1651	26	STP670	SPL136	1701	26
STP647	SPL132	1652	26	STP671	OPEN	1702	26
STP648	OPEN	1653	26	STP671	SPL136	1703	26
STP648	SPL132	1654	26	STP672	OPEN	1704	26
STP649	OPEN	1655	26	STP672	SPL136	1705	26
STP649	SPL132	1656	26	STP673	OPEN	1706	26
STP650	OPEN	1657	26	STP673	SPL136	1707	26
STP650	SPL132	1658	26	STP674	OPEN	1708	26
STP651	OPEN	1660	26	STP674	SPL136	1709	26
STP651	SPL133	1661	26	STP675	OPEN	1710	26
STP652	OPEN	1662	26	STP675	SPL136	1711	26
STP652	SPL133	1663	26	STP676	OPEN	1713	26
STP653	OPEN	1664	26	STP676	SPL137	1714	26
STP653	SPL133	1665	26	STP677	OPEN	1715	26
STP654	OPEN	1666	26	STP677	SPL137	1716	26
STP654	SPL133	1667	26	STP678	OPEN	1717	26
STP655	OPEN	1668	26	STP678	SPL137	1718	26
STP655	SPL133	1669	26	STP679	OPEN	1719	26
STP656	OPEN	1670	26	STP679	SPL137	1720	26
STP656	SPL133	1671	26	STP680	OPEN	1721	26
STP657	OPEN	1672	26	STP680	SPL137	1722	26
STP657	SPL133	1673	26	STP681	OPEN	1723	26
STP658	OPEN	1675	26	STP681	SPL137	1724	26
STP658	SPL134	1676	26	STP682	OPEN	1725	26
STP659	OPEN	1677	26	STP682	SPL137	1726	26
STP659	SPL134	1678	26	STP683	OPEN	1727	26
STP660	OPEN	1679	26	STP683	SPL137	1728	26
STP660	SPL134	1680	26	STP684	OPEN	1730	26
STP661	OPEN	1681	26	STP684	SPL138	1731	26
STP661	SPL134	1682	26	STP685	OPEN	1732	26
STP662	OPEN	1683	26	STP685	SPL138	1733	26
STP662	SPL134	1684	26	STP686	OPEN	1734	26

## 3-31. MAJOR TEST ADAPTER (cont)

3-31

FROM	TO	WIRE ID	WIRE SIZE	FROM	TO	WIRE ID	WIRE SIZE
STP686	SPL138	1735	26	STP710	OPEN	1786	26
STP687	OPEN	1736	26	STP710	SPL141	1787	26
STP687	SPL138	1737	26	STP711	OPEN	1789	26
STP688	OPEN	1738	26	STP711	SPL142	1790	26
STP688	SPL138	1739	26	STP712	OPEN	1791	26
STP689	OPEN	1740	26	STP712	SPL142	1792	26
STP689	SPL138	1741	26	STP713	OPEN	1793	26
STP690	OPEN	1742	26	STP713	SPL142	1794	26
STP690	SPL138	1743	26	STP714	OPEN	1795	26
STP691	OPEN	1745	26	STP714	SPL142	1796	26
STP691	SPL139	1746	26	STP715	OPEN	1797	26
STP692	OPEN	1747	26	STP715	SPL142	1798	26
STP692	SPL139	1748	26	STP716	OPEN	1799	26
STP693	OPEN	1749	26	STP716	SPL142	1800	26
STP693	SPL139	1750	26	STP717	OPEN	1801	26
STP694	OPEN	1751	26	STP717	SPL142	1802	26
STP694	SPL139	1752	26	STP718	OPEN	1804	26
STP695	OPEN	1753	26	STP718	SPL143	1805	26
STP695	SPL139	1754	26	STP719	OPEN	1806	26
STP696	OPEN	1755	26	STP719	SPL143	1807	26
STP696	SPL139	1756	26	STP720	OPEN	1808	26
STP697	OPEN	1758	26	STP720	SPL143	1809	26
STP697	SPL140	1759	26	STP721	OPEN	1810	26
STP698	OPEN	1760	26	STP721	SPL143	1811	26
STP698	SPL140	1761	26	STP722	OPEN	1812	26
STP699	OPEN	1762	26	STP722	SPL143	1813	26
STP699	SPL140	1763	26	STP723	OPEN	1815	26
STP700	OPEN	1764	26	STP723	SPL144	1816	26
STP700	SPL140	1765	26	STP724	OPEN	1817	26
STP701	OPEN	1766	26	STP724	SPL144	1818	26
STP701	SPL140	1767	26	STP725	OPEN	1819	26
STP702	OPEN	1768	26	STP725	SPL144	1820	26
STP702	SPL140	1769	26	STP726	OPEN	1821	26
STP703	OPEN	1770	26	STP726	SPL144	1822	26
STP703	SPL140	1771	26	STP727	OPEN	1823	26
STP704	OPEN	1774	26	STP727	SPL144	1824	26
STP704	SPL141	1775	26	STP728	OPEN	1825	26
STP705	OPEN	1776	26	STP728	SPL144	1826	26
STP705	SPL141	1777	26	STP729	OPEN	1827	26
STP706	OPEN	1778	26	STP729	SPL144	1828	26
STP706	SPL141	1779	26	STP730	OPEN	1829	26
STP707	OPEN	1780	26	STP730	SPL144	1830	26
STP707	SPL141	1781	26	STP731	OPEN	1832	26
STP708	OPEN	1782	26	STP731	SPL145	1833	26
STP708	SPL141	1783	26	STP732	OPEN	1834	26
STP709	OPEN	1784	26	STP732	SPL145	1835	26
STP709	SPL141	1785	26	STP733	OPEN	1836	26



## 3-31. MAJOR TEST ADAPTER (cont)

3-31

FROM	TO	WIRE ID	WIRE SIZE	FROM	TO	WIRE ID	WIRE SIZE	FROM	TO	WIRE ID	WIRE SIZE
STP733	SPL145	1837	26	STP757	OPEN	1888	26	1-108	1-107	1189	26
STP734	OPEN	1838	26	STP757	SPL149	1889	26	1-108	1-109	1188	26
STP734	SPL145	1839	26	STP758	OPEN	1890	26	1-109	1-108	1188	26
STP735	OPEN	1840	26	STP758	SPL149	1891	26	1-109	1-110	1187	26
STP735	SPL145	1841	26	STP759	OPEN	1892	26				
STP736	OPEN	1842	26	STP759	SPL149	1893	26				
STP736	SPL145	1843	26	STP760	OPEN	1894	26				
STP737	OPEN	1844	26	STP760	SPL149	1895	26				
STP737	SPL145	1845	26	STP761	OPEN	1896	26				
STP738	OPEN	1847	26	STP761	SPL149	1897	26				
STP738	SPL146	1848	26	STP762	OPEN	1898	26				
STP739	OPEN	1849	26	STP762	SPL149	1899	26				
STP739	SPL146	1850	26	STP763	OPEN	1900	26				
STP740	OPEN	1851	26	STP763	SPL149	1901	26				
STP740	SPL146	1852	26	STP764	OPEN	773	26				
STP741	OPEN	1853	26	STP764	SPL87	774	26				
STP741	SPL146	1854	26	STP765	OPEN	775	26				
STP742	OPEN	1855	26	STP765	SPL87	776	26				
STP742	SPL146	1856	26	SW1-3	J4-L4	1249	26				
STP743	OPEN	1857	26	SW1-4	J4-b3	1250	26				
STP743	SPL146	1858	26	SW2-COM	J4-L3	1247	26				
STP744	OPEN	1859	26	SW2-NO	J4-L4	1248	26				
STP744	SPL146	1860	26	SW3-3	SW4-NO	1258	26				
STP745	OPEN	1862	26	SW3-4	9-6	1263	26				
STP745	SPL147	1863	26	SW4-COM	8-7	1256	26				
STP746	OPEN	1864	26	SW4-NO	J4-X4	1257	26				
STP746	SPL147	1865	26	SW4-NO	SW3-3	1258	26				
STP747	OPEN	1866	26	1-1	2-1	1010	26				
STP747	SPL147	1867	26	1-2	1-3	1019	26				
STP748	OPEN	1868	26	1-2	2-2	1018	26				
STP748	SPL147	1869	26	1-3	1-2	1019	26				
STP749	OPEN	1871	26	1-3	2-3	1020	26				
STP749	SPL148	1872	26	1-4	1-5	1029	26				
STP750	OPEN	1873	26	1-4	2-4	1028	26				
STP750	SPL148	1874	26	1-5	1-4	1029	26				
STP751	OPEN	1875	26	1-5	1-106	997	26				
STP751	SPL148	1876	26	1-5	2-5	1030	26				
STP752	OPEN	1877	26	1-97	J2-G1	437	26				
STP752	SPL148	1878	26	1-97	1-107	1295	26				
STP753	OPEN	1879	26	1-103	P1-Y17	340	26				
STP753	SPL148	1880	26	1-106	1-5	997	26				
STP754	OPEN	1881	26	1-106	2-106	1129	26				
STP754	SPL148	1882	26	1-106	1-107	1190	26				
STP755	OPEN	1883	26	1-106	22-25	1000	26				
STP755	SPL148	1884	26	1-107	1-97	1295	26				
STP756	OPEN	1885	26	1-107	1-106	1190	26				
STP756	SPL148	1886	26	1-107	1-108	1189	26				

## 3-31. MAJOR TEST ADAPTER (cont)

3-31

FROM	TO	WIRE ID	WIRE SIZE	FROM	TO	WIRE ID	WIRE SIZE
1-110	1-109	1187	26	3-109	3-108	1178	26
1-110	2-110	1186	26	3-109	3-110	1177	26
2-1	1-1	1010	26	3-110	3-109	1177	26
2-1	3-1	1011	26	3-110	4-110	1176	26
2-2	1-2	1018	26	4-1	3-1	1012	26
2-2	3-2	1017	26	4-1	5-1	1013	26
2-3	1-3	1020	26	4-2	3-2	1016	26
2-3	3-3	1021	26	4-2	5-2	1015	26
2-4	1-4	1028	26	4-3	3-3	1022	26
2-4	3-4	1027	26	4-3	5-3	1023	26
2-5	1-5	1030	26	4-4	3-4	1026	26
2-5	3-5	1031	26	4-4	5-4	1025	26
2-106	1-106	1129	26	4-5	3-5	1032	26
2-106	3-106	1130	26	4-5	5-5	1033	26
2-106	2-107	1182	26	4-5	SPL93	839	26
2-106	3-106	1181	26	4-7	J1-a3	1742	26
2-106	STP154	342	26	4-9	J1-a5	1747	26
2-106	STP204	439	26	4-11	P1-Z23	391	26
2-107	2-106	1182	26	4-13	J1-Y1	1670	26
2-107	2-108	1183	26	4-15	J1-Y3	1675	26
2-108	2-107	1183	26	4-17	J1-Y5	1679	26
2-108	2-109	1184	26	4-19	J1-Z1	1683	26
2-109	2-108	1184	26	4-25	J1-a1	1738	26
2-109	2-110	1185	26	4-27	28-17	824	26
2-110	2-109	1185	26	4-29	28-19	828	26
2-110	1-110	1186	26	4-31	28-21	832	26
3-1	2-1	1011	26	4-33	28-23	836	26
3-1	4-1	1012	26	4-35	J1-b2	1753	26
3-2	4-2	1016	26	4-37	J1-b4	1758	26
3-2	2-2	1017	26	4-39	J1-b6	1762	26
3-3	2-3	1011	26	4-41	J1-c2	1766	26
3-3	4-3	1022	26	4-43	J3-R6	981	26
3-4	4-4	1026	26	4-45	J3-T6	985	26
3-4	2-4	1027	26	4-47	J3-V5	989	26
3-5	2-5	1031	26	4-49	J3-V3	993	26
3-5	4-5	1032	26	4-53	17-94	908	26
3-67	22-107	998	26	4-55	17-96	923	26
3-68	23-107	999	26	4-57	17-98	927	26
3-106	SPL101	933	26	4-59	17-100	931	26
3-106	2-106	1130	26	4-71	4-106	1009	26
3-106	4-106	1131	26	4-77	10-77	937	26
3-106	2-106	1181	26	4-79	10-79	941	26
3-106	3-107	1180	26	4-81	10-81	945	26
3-107	3-106	1180	26	4-83	10-83	949	26
3-107	3-108	1179	26	4-85	J1-c4	1770	26
3-108	3-107	1179	26	4-105	4-106	1294	26
3-108	3-109	1178	26	4-105	5-70	1293	26

3-31. MAJOR TEST ADAPTER (cont)

FROM	TO	WIRE ID	WIRE SIZE	FROM	TO	WIRE ID	WIRE SIZE
4-106	4-105	1294	26	5-58	16-99	929	26
4-106	4-71	1009	26	5-70	4-105	1293	26
4-106	3-106	1131	26	5-76	11-76	935	26
4-106	5-106	1132	26	5-78	11-78	939	26
4-106	4-107	1172	26	5-80	11-80	943	26
4-107	4-106	1172	26	5-82	11-82	947	26
4-107	4-108	1173	26	5-84	J1-c3	1768	26
4-108	4-107	1173	26	5-106	SPL104	952	26
4-108	4-109	1174	26	5-106	SPL108	996	26
4-109	4-108	1174	26	5-106	4-106	1132	26
4-109	4-110	1175	26	5-106	8-106	1133	26
4-110	4-109	1175	26	5-106	5-107	1170	26
4-110	3-110	1176	26	5-107	5-106	1170	26
5-1	4-1	1013	26	5-107	5-108	1169	26
5-1	5-2	1014	26	5-108	5-107	1169	26
5-2	5-1	1014	26	5-108	5-109	1168	26
5-2	4-2	1015	26	5-109	5-108	1168	26
5-3	4-3	1023	26	5-109	5-110	1167	26
5-3	5-4	1024	26	5-110	5-109	1167	26
5-4	4-4	1025	26	8-1	8-2	1052	26
5-4	5-3	1024	26	8-2	8-1	1052	26
5-5	4-5	1033	26	8-2	8-3	1051	26
5-5	8-5	1242	26	8-3	8-2	1051	26
5-5	STP182	393	26	8-3	8-4	1050	26
5-6	J1-a2	1740	26	8-4	8-3	1050	26
5-8	J1-a4	1745	26	8-4	8-5	1049	26
5-10	J1-a6	1749	26	8-5	8-4	1049	26
5-12	J1-X6	1668	26	8-5	9-5	1048	26
5-14	J1-Y2	1672	26	8-5	5-5	1242	26
5-16	J1-Y4	1677	26	8-7	SW4-COM	1256	26
5-18	J1-Y6	1681	26	8-7	14-7	1255	26
5-20	J1-Z2	1685	26	8-21	J1-Z3	1730	26
5-26	29-16	822	26	8-23	J1-Z5	1734	26
5-28	SPL92	838	26	8-25	32-73	1687	26
5-28	29-18	826	26	8-27	32-75	1691	26
5-30	29-20	830	26	8-29	32-77	1695	26
5-32	29-22	834	26	8-31	32-79	1700	26
5-34	J1-b1	1751	26	8-33	32-81	1704	26
5-36	J1-b3	1755	26	8-35	32-83	1708	26
5-38	J1-b5	1760	26	8-37	15-26	1713	26
5-40	J1-c1	1764	26	8-39	15-28	1717	26
5-42	J3-P6	979	26	8-41	15-30	1721	26
5-44	J3-S6	983	26	8-43	15-32	1725	26
5-46	J3-V6	987	26	8-45	J1-W1	1645	26
5-48	J3-V4	991	26	8-47	J1-W3	1649	26
5-52	16-93	906	26	8-49	J1-W5	1653	26
5-54	16-95	910	26	8-51	J1-X1	1657	26
5-56	16-97	925	26				

## 3-31. MAJOR TEST ADAPTER (cont)

3-31

FROM	TO	WIRE ID	WIRE SIZE	FROM	TO	WIRE ID	WIRE SIZE
8-53	J1-X3	1662	26	9-109	10-109	1165	26
8-55	J1-X5	1666	26	9-109	8-109	1166	26
8-65	14-65	1280	26	9-110	8-110	1159	26
8-71	14-71	1271	26	9-110	10-110	1158	26
8-106	5-106	1133	26	10-1	9-1	1043	26
8-106	9-106	1134	26	10-1	10-2	1042	26
8-107	9-107	1153	26	10-2	10-1	1042	26
8-108	9-108	1160	26	10-2	10-3	1041	26
8-109	9-109	1166	26	10-3	10-2	1041	26
8-110	9-110	1159	26	10-3	10-4	1040	26
9-1	9-2	1044	26	10-4	10-3	1040	26
9-1	10-1	1043	26	10-4	10-5	1039	26
9-2	9-1	1044	26	10-5	10-4	1039	26
9-2	9-3	1045	26	10-5	11-5	1038	26
9-3	9-2	1045	26	10-5	STP178	386	26
9-3	9-4	1046	26	10-9	P1-Z21	384	26
9-4	9-3	1046	26	10-11	J1-K3	1520	26
9-4	9-5	1047	26	10-13	J1-K5	1524	26
9-5	9-4	1047	26	10-15	J1-L1	1528	26
9-5	8-5	1048	26	10-17	J1-L3	1532	26
9-6	SW3-4	1263	26	10-19	J1-L5	1537	26
9-6	15-6	1262	26	10-21	J1-M1	1541	26
9-22	J1-Z4	1732	26	10-23	J1-M3	1545	26
9-24	J1-Z6	1736	26	10-25	J1-M5	1550	26
9-26	33-74	1689	26	10-27	J1-N1	1554	26
9-28	33-76	1693	26	10-29	J1-N3	1558	26
9-30	33-78	1697	26	10-31	J1-N5	1563	26
9-32	33-80	1702	26	10-33	J1-P1	1567	26
9-34	33-82	1706	26	10-35	J1-P3	1571	26
9-36	33-84	1710	26	10-37	J1-P5	1576	26
9-38	14-27	1715	26	10-39	J1-R1	1580	26
9-40	14-29	1719	26	10-41	J1-R3	1584	26
9-42	14-31	1723	26	10-43	J1-R5	1589	26
9-44	14-33	1727	26	10-45	J1-S1	1593	26
9-46	J1-W2	1647	26	10-47	J1-S3	1597	26
9-48	J1-W4	1651	26	10-49	J1-S5	1602	26
9-50	J1-W6	1655	26	10-51	J1-T1	1606	26
9-52	J1-X2	1660	26	10-53	J1-T3	1610	26
9-54	J1-X4	1664	26	10-55	J1-T5	1614	26
9-66	15-66	1299	26	10-57	J1-U1	1619	26
9-70	15-70	1267	26	10-59	J1-U3	1623	26
9-72	15-72	1275	26	10-61	J1-U5	1627	26
9-106	8-106	1134	26	10-63	J1-V1	1632	26
9-106	10-106	1135	26	10-65	J1-V3	1636	26
9-107	8-107	1153	26	10-67	J1-V5	1640	26
9-107	10-107	1154	26	10-71	10-106	1008	26
9-108	8-108	1160	26	10-77	4-77	937	26
9-108	10-108	1161	26				

## 3-31. MAJOR TEST ADAPTER (cont)

3-31

FROM	TO	WIRE ID	WIRE SIZE	FROM	TO	WIRE ID	WIRE SIZE
10-79	4-79	941	26	11-46	J1-S2	1595	26
10-81	4-81	945	26	11-48	J1-S4	1599	26
10-83	4-83	949	26	11-50	J1-S6	1604	26
10-101	J2-c2	580	26	11-52	J1-T2	1608	26
10-103	J2-c4	586	26	11-54	J1-T4	1612	26
10-105	J2-c6	590	26	11-56	J1-T6	1617	26
10-106	10-71	1008	26	11-58	J1-U2	1621	26
10-106	9-106	1135	26	11-60	J1-U4	1625	26
10-106	11-106	1136	26	11-62	J1-U6	1629	26
10-106	SPL103	951	26	11-64	J1-V2	1634	26
10-107	SPL67	582	26	11-66	J1-V4	1638	26
10-107	11-107	1155	26	11-68	J1-V6	1642	26
10-107	9-107	1154	26	11-70	11-90	1291	26
10-108	9-108	1161	26	11-76	5-76	935	26
10-108	11-108	1162	26	11-78	5-78	939	26
10-109	9-109	1165	26	11-80	5-80	943	26
10-109	11-109	1164	26	11-82	5-82	947	26
10-110	9-110	1158	26	11-90	11-106	1292	26
10-110	11-110	1157	26	11-90	11-70	1291	26
11-1	11-2	1034	26	11-100	J2-c1	578	26
11-2	11-3	1035	26	11-102	J2-c3	584	26
11-2	11-1	1034	26	11-104	J2-c5	588	26
11-3	11-2	1035	26	11-106	11-90	1292	26
11-3	11-4	1036	26	11-106	10-106	1136	26
11-4	11-3	1036	26	11-106	14-106	1137	26
11-4	11-5	1037	26	11-107	10-107	1155	26
11-5	11-4	1037	26	11-107	11-110	1156	26
11-5	10-5	1038	26	11-107	SPL69	593	26
11-5	14-5	1243	26	11-108	10-108	1162	26
11-10	J1-K2	1518	26	11-108	11-109	1163	26
11-12	J1-K4	1522	26	11-109	11-108	1163	26
11-14	J1-K6	1526	26	11-109	10-109	1164	26
11-16	J1-L2	1530	26	11-110	10-110	1157	26
11-18	J1-L4	1535	26	11-110	11-107	1156	26
11-20	J1-L6	1539	26	14-1	14-2	1071	26
11-22	J1-M2	1543	26	14-2	14-1	1071	26
11-24	J1-M4	1547	26	14-2	14-3	1070	26
11-26	J1-M6	1552	26	14-3	14-2	1070	26
11-28	J1-N2	1556	26	14-3	14-4	1069	26
11-30	J1-N4	1560	26	14-4	14-3	1069	26
11-32	J1-N6	1565	26	14-4	14-5	1068	26
11-34	J1-P2	1569	26	14-5	11-5	1243	26
11-36	J1-P4	1573	26	14-5	14-4	1068	26
11-38	J1-P6	1578	26	14-5	15-5	1067	26
11-40	J1-R2	1582	26	14-7	8-7	1255	26
11-42	J1-R4	1586	26	14-7	20-101	1254	26
11-44	J1-R6	1591	26	14-9	P1-S18	1515	26

## 3-31. MAJOR TEST ADAPTER (cont)

3-31

FROM	TO	WIRE ID	WIRE SIZE	FROM	TO	WIRE ID	WIRE SIZE
14-11	P1-D25	1483	26	15-5	14-5	1067	26
14-13	P1-C17	1487	26	15-6	9-6	1262	26
14-15	P1-C22	1491	26	15-6	21-100	1261	26
14-17	P1-C26	1496	26	15-10	P1-D23	1481	26
14-19	P1-B16	1501	26	15-12	P1-C15	1485	26
14-21	P1-B21	1505	26	15-14	P1-C19	1489	26
14-23	P1-B25	1509	26	15-16	P1-C24	1494	26
14-25	P1-A17	1513	26	15-18	P1-B14	1498	26
14-27	9-38	1715	26	15-20	P1-B18	1503	26
14-29	9-40	1719	26	15-22	P1-B23	1507	26
14-31	9-42	1723	26	15-24	P1-A15	1511	26
14-33	9-44	1727	26	15-26	8-37	1713	26
14-35	32-15	1776	26	15-28	8-39	1717	26
14-37	32-17	1780	26	15-30	8-41	1721	26
14-39	32-19	1784	26	15-32	8-43	1725	26
14-41	32-21	1789	26	15-34	33-14	1774	26
14-43	32-23	1793	26	15-36	33-16	1778	26
14-45	32-25	1797	26	15-38	33-18	1782	26
14-47	32-27	1801	26	15-40	33-20	1786	26
14-49	32-29	1806	26	15-42	33-22	1791	26
14-51	32-31	1810	26	15-44	33-24	1795	26
14-65	8-65	1280	26	15-46	33-26	1799	26
14-65	21-96	1279	26	15-48	33-28	1804	26
14-71	8-71	1271	26	15-50	33-30	1808	26
14-71	20-71	1270	26	15-52	33-32	1812	26
14-101	J2-b2	568	26	15-66	20-97	1298	26
14-103	J2-b4	572	26	15-66	9-66	1299	26
14-105	J2-b6	576	26	15-70	9-70	1267	26
14-106	11-106	1137	26	15-70	21-70	1266	26
14-106	15-106	1138	26	15-72	9-72	1275	26
14-107	15-107	1191	26	15-72	21-72	1274	26
14-107	J4-b3	781	26	15-100	J2-b1	566	26
14-108	J4-b1	781	26	15-102	J2-b3	570	26
14-108	15-108	1198	26	15-104	J2-b5	574	26
14-109	J4-b2	784	26	15-106	14-106	1138	26
14-109	15-109	1204	26	15-106	16-106	1139	26
14-110	J4-b4	784	26	15-107	14-107	1191	26
14-110	15-110	1197	26	15-107	16-107	1192	26
15-1	15-2	1063	26	15-108	14-108	1198	26
15-1	16-1	1062	26	15-108	16-108	1199	26
15-2	15-1	1063	26	15-109	16-109	1203	26
15-2	15-3	1064	26	15-109	14-109	1204	26
15-3	15-2	1064	26	15-110	14-110	1197	26
15-3	15-4	1065	26	15-110	16-110	1196	26
15-4	15-3	1065	26	16-1	15-1	1062	26
15-4	15-5	1066	26	16-1	16-2	1061	26
15-5	15-4	1066	26	16-2	16-1	1061	26

FROM	TO	WIRE ID	WIRE SIZE	FROM	TO	WIRE ID	WIRE SIZE
16-2	16-3	1060	26	16-81	26-15	968	26
16-3	16-2	1060	26	16-83	26-17	974	26
16-3	16-4	1059	26	16-85	J1-H5	1309	26
16-4	16-3	1059	26	16-87	J1-J1	1313	26
16-4	16-5	1058	26	16-89	J1-J3	1318	26
16-5	16-4	1058	26	16-91	J1-J5	1322	26
16-5	17-5	1057	26	16-93	5-52	906	26
16-5	STP174	380	26	16-95	5-54	910	26
16-7	29-36	840	26	16-97	5-56	925	26
16-9	29-38	846	26	16-99	5-58	929	26
16-11	29-40	852	26	16-103	J4-Z3	773	26
16-13	29-42	858	26	16-105	J4-a3	775	26
16-15	P1-G1	59	26	16-106	SPL71	611	26
16-17	P1-G5	63	26	16-106	SPL106	978	26
16-19	P1-G10	67	26	16-106	15-106	1139	26
16-21	P1-E2	45	26	16-106	17-106	1140	26
16-23	P1-E6	49	26	16-107	15-107	1192	26
16-25	P1-E11	55	26	16-107	17-107	1193	26
16-27	P1-D1	31	26	16-108	15-108	1199	26
16-29	P1-D5	37	26	16-108	17-108	1200	26
16-31	P1-D10	41	26	16-109	15-109	1203	26
16-33	P1-C2	19	26	16-109	17-109	1202	26
16-35	P1-C6	23	26	16-110	15-110	1196	26
16-37	P1-C11	27	26	16-110	17-110	1195	26
16-39	P1-B1	5	26	17-1	17-2	1053	26
16-41	P1-B5	9	26	17-2	17-1	1053	26
16-43	P1-B10	13	26	17-2	17-3	1054	26
16-45	P1-A2	1	26	17-3	17-2	1054	26
16-47	J1-G6	1303	26	17-3	17-4	1055	26
16-49	J2-J1	452	26	17-4	17-3	1055	26
16-51	J2-J3	456	26	17-4	17-5	1056	26
16-53	J2-J5	462	26	17-4	SPL95	865	26
16-55	J3-A2	594	26	17-5	17-4	1056	26
16-57	J2-H3	444	26	17-5	16-5	1057	26
16-59	J2-H5	448	26	17-5	20-5	1244	26
16-61	J3-B2	596	26	17-6	P1-Z18	378	26
16-63	J3-D2	600	26	17-8	28-37	843	26
16-65	J4-A1	624	26	17-10	28-39	849	26
16-67	J4-A3	628	26	17-12	28-41	855	26
16-69	J4-A5	632	26	17-14	28-43	861	26
16-71	20-95	1289	26	17-16	P1-G3	61	26
16-71	SPL3	36	26	17-18	P1-G8	65	26
16-73	17-70	1001	26	17-20	P1-G12	69	26
16-73	17-72	1002	26	17-22	P1-E4	47	26
16-75	J1-K1	1326	26	17-24	P1-E9	51	26
16-77	26-9	956	26	17-26	P1-E13	57	26
16-79	26-11	962	26	17-28	P1-D3	33	26

## 3-31. MAJOR TEST ADAPTER (cont)

3-31

FROM	TO	WIRE ID	WIRE SIZE	FROM	TO	WIRE ID	WIRE SIZE
17-30	P1-D8	39	26	17-107	17-110	1194	26
17-32	P1-D12	43	26	17-108	16-108	1200	26
17-34	P1-C4	21	26	17-108	17-109	1201	26
17-36	P1-C9	25	26	17-109	16-109	1202	26
17-38	P1-C13	29	26	17-109	17-108	1201	26
17-40	P1-B3	7	26	17-110	16-110	1195	26
17-42	P1-B8	11	26	17-110	17-107	1194	26
17-44	P1-B12	15	26	18-46	SPL79	679	26
17-46	17-106	1004	26	20-1	20-2	1090	26
17-46	17-72	1003	26	20-2	20-1	1090	26
17-48	J2-K6	478	26	20-2	20-3	1089	26
17-50	J2-J2	454	26	20-3	SPL75	641	26
17-52	J2-J4	460	26	20-3	20-2	1089	26
17-54	J2-J6	464	26	20-3	20-4	1088	26
17-56	J2-H2	442	26	20-4	20-3	1088	26
17-58	J2-H4	446	26	20-4	20-5	1087	26
17-60	J2-H6	450	26	20-4	SPL97	891	26
17-62	J3-C2	598	26	20-4	SPL99	905	26
17-64	J3-E2	602	26	20-5	SPL57	495	26
17-66	J4-A2	626	26	20-5	17-5	1244	26
17-68	J4-A4	630	26	20-5	20-4	1087	26
17-70	SPL7	72	26	20-5	21-5	1086	26
17-70	16-73	1001	26	20-7	26-27	919	26
17-72	16-72	1002	26	20-9	26-31	912	26
17-72	17-46	1003	26	20-11	28-45	869	26
17-74	J1-H2	1305	26	20-13	32-37	875	COAX
17-76	27-8	953	26	20-15	32-39	881	26
17-78	27-10	959	26	20-17	32-41	887	26
17-80	27-14	965	26	20-19	32-43	895	26
17-82	27-16	971	26	20-21	32-45	901	26
17-84	J1-H4	1307	26	20-23	J2-N2	508	26
17-86	J1-H6	1311	26	20-25	J2-N4	514	26
17-88	J1-J2	1316	26	20-27	J2-N6	518	26
17-90	J1-J4	1320	26	20-29	J2-M2	496	26
17-92	J1-J6	1324	26	20-31	J2-M4	500	26
17-94	4-53	908	26	20-33	J2-M6	504	26
17-96	4-55	923	26	20-35	J2-L2	482	26
17-98	4-57	927	26	20-37	J2-L4	486	26
17-100	4-59	931	26	20-39	J2-L6	490	26
17-102	J4-Z2	773	26	20-41	J2-K2	468	26
17-104	J4-Z4	775	26	20-43	J2-K4	472	26
17-106	SPL102	934	26	20-45	P1-A4	3	26
17-106	17-46	1004	26	20-47	J4-M2	683	26
17-106	16-106	1140	26	20-49	J4-M4	686	26
17-106	20-106	1141	26	20-51	J4-M6	689	26
17-107	SPL53	459	26	20-53	J4-G5	660	26
17-107	16-107	1193	26	20-55	J4-H5	669	26



3-31. MAJOR TEST ADAPTER (cont)

FROM	TO	WIRE ID	WIRE SIZE	FROM	TO	WIRE ID	WIRE SIZE
20-57	J4-H3	666	26	21-4	21-5	1085	26
20-59	J4-H1	663	26	21-5	21-4	1085	26
20-61	J4-J5	675	26	21-5	20-5	1086	26
20-63	J4-J3	672	26	21-5	SPL55	476	26
20-65	21-96	1278	26	21-5	SPL59	512	26
20-65	26-75	1277	26	21-6	26-25	919	26
20-67	J4-B2	638	26	21-8	26-29	912	26
20-69	J4-A6	634	26	21-10	29-44	866	26
20-71	14-71	1270	26	21-12	33-36	872	26
20-71	27-82	1269	26	21-14	33-38	878	26
20-73	J4-S5	706	26	21-16	33-40	884	26
20-75	J4-T5	706	26	21-18	33-42	892	26
20-77	J4-T1	712	26	21-20	33-44	898	26
20-79	J4-U1	718	26	21-22	J2-N1	506	26
20-79	J4-U1	721	26	21-24	J2-N3	510	26
20-81	J4-U3	718	26	21-26	J2-N5	516	26
20-81	J4-U3	721	26	21-28	J2-M1	492	26
20-83	J4-T3	715	26	21-30	J2-M3	498	26
20-85	P1-M22	1469	26	21-32	J2-M5	502	26
20-87	P1-M26	1473	26	21-34	J2-L1	480	26
20-91	P1-L18	1479	26	21-36	J2-L3	484	26
20-89	J4-c3	791	26	21-38	J2-L5	488	26
20-93	J4-c2	787	26	21-40	J2-K1	466	26
20-95	16-71	1289	26	21-42	J2-K3	470	26
20-95	20-106	1290	26	21-44	J2-K5	474	26
20-97	15-66	1298	26	21-46	J4-M1	683	26
20-97	21-66	1297	26	21-48	J4-M3	686	26
20-99	J4-c6	793	26	21-50	J4-M5	689	26
20-101	14-7	1254	26	21-52	J4-G6	660	26
20-101	32-101	1253	26	21-54	J4-H6	669	26
20-103	J4-Z6	777	26	21-56	J4-H4	666	26
20-105	J4-a6	779	26	21-58	J4-H2	663	26
20-106	SPL88	790	26	21-60	J4-J6	675	26
20-106	17-106	1141	26	21-62	J4-J4	672	26
20-106	20-95	1290	26	21-66	33-66	1296	26
20-106	21-106	1142	26	21-66	20-97	1297	26
20-107	21-107	1205	26	21-68	J4-B1	636	26
20-108	21-108	1212	26	21-70	15-70	1266	26
20-109	21-109	1218	26	21-70	27-80	1265	26
20-110	21-110	1211	26	21-72	15-72	1274	26
21-1	21-2	1082	26	21-72	27-84	1273	26
21-1	22-1	1081	26	21-74	J4-S6	709	26
21-2	21-1	1082	26	21-76	J4-T6	709	26
21-2	21-3	1083	26	21-78	J4-T2	712	26
21-3	21-2	1083	26	21-80	J4-U2	724	26
21-3	21-4	1084	26	21-80	J4-U2	727	26
21-4	21-3	1084	26	21-82	J4-U4	724	26

## 3-31. MAJOR TEST ADAPTER (cont)

3-31

FROM	TO	WIRE ID	WIRE SIZE	FROM	TO	WIRE ID	WIRE SIZE
21-82	J4-U4	727	26	22-55	J4-L1	680	26
21-84	J4-T4	715	26	22-106	21-106	1143	26
21-86	P1-M24	1471	26	22-106	23-106	1144	26
21-88	P1-L14	1475	26	22-107	3-67	998	26
21-90	P1-L16	1477	26	22-107	21-107	1206	26
21-92	J4-c1	787	26	22-107	23-107	1207	26
21-94	J4-c4	793	26	22-108	21-108	1213	26
21-96	14-65	1279	26	22-108	23-108	1214	26
21-96	20-65	1278	26	22-109	23-109	1216	26
21-98	J4-c5	791	26	22-109	21-109	1217	26
21-100	15-6	1261	26	22-110	21-110	1210	26
21-100	33-100	1260	26	22-110	23-110	1209	26
21-102	J4-Z5	777	26	23-1	23-2	1072	26
21-104	J4-a5	779	26	23-2	23-1	1072	26
21-106	20-106	1142	26	23-2	23-3	1073	26
21-106	22-106	1143	26	23-3	23-2	1073	26
21-107	20-107	1205	26	23-3	23-4	1074	26
21-107	22-107	1206	26	23-4	23-3	1074	26
21-107	27-76	1906	26	23-4	23-5	1075	26
21-108	20-108	1212	26	23-4	STP170	374	26
21-108	22-108	1213	26	23-5	23-4	1075	26
21-109	20-109	1218	26	23-5	22-5	1076	26
21-109	22-109	1217	26	23-5	26-5	1245	26
21-110	20-110	1211	26	23-8	STP459	953	26
21-110	22-110	1210	26	23-10	STP463	959	26
22-1	21-1	1081	26	23-12	P1-Z16	372	26
22-1	22-2	1080	26	23-14	STP467	965	26
22-2	22-1	1080	26	23-16	STP471	971	26
22-2	22-3	1079	26	23-28	22-27	1283	26
22-3	22-2	1079	26	23-28	23-80	1284	26
22-3	22-4	1078	26	23-36	28-27	806	26
22-4	22-3	1078	26	23-38	28-29	810	26
22-4	22-5	1077	26	23-40	28-31	814	26
22-5	22-4	1077	26	23-42	28-33	818	26
22-5	23-5	1076	26	23-52	SPL83	731	26
22-5	SPL91	821	26	23-56	J4-L2	680	26
22-9	STP461	956	26	23-80	23-28	1284	26
22-11	STP465	962	26	23-80	23-82	1285	26
22-15	STP469	968	26	23-82	23-84	1286	26
22-17	STP473	974	26	23-82	23-80	1285	26
22-25	1-106	1000	26	23-84	23-82	1286	26
22-25	SPL100	922	26	23-84	23-104	1287	26
22-27	23-28	1283	26	23-104	23-84	1287	26
22-35	29-26	804	26	23-104	23-106	1288	26
22-37	29-28	808	26	23-106	22-106	1144	26
22-39	29-30	812	26	23-106	23-104	1288	26
22-41	29-32	816	26	23-106	26-106	1145	26

3-31. MAJOR TEST ADAPTER (cont)

FROM	TO	WIRE ID	WIRE SIZE	FROM	TO	WIRE ID	WIRE SIZE
23-107	3-68	999	26	27-2	27-3	1102	26
23-107	22-107	1207	26	27-3	27-2	1102	26
23-107	23-110	1208	26	27-3	27-4	1103	26
23-108	22-108	1214	26	27-4	27-3	1103	26
23-108	23-109	1215	26	27-4	27-5	1104	26
23-108	26-75	1905	26	27-5	27-4	1104	26
23-109	23-108	1215	26	27-5	26-5	1105	26
23-109	22-109	1216	26	27-8	17-76	953	26
23-110	23-107	1208	26	27-10	17-78	959	26
23-110	22-110	1209	26	27-14	17-80	965	26
23-110	33-66	1907	26	27-16	17-82	971	26
25-75	32-65	1276	26	27-26	J2-P1	915	26
26-1	26-2	1109	26	27-28	J2-P2	915	26
26-2	26-1	1109	26	27-30	J2-P3	917	26
26-2	26-3	1108	26	27-32	J2-P4	917	26
26-3	26-2	1108	26	27-56	J4-N3	695	26
26-3	26-4	1107	26	27-58	J4-N6	698	26
26-4	26-3	1107	26	27-60	J4-N2	692	26
26-4	26-5	1106	26	27-76	21-107	1906	26
26-4	SPL105	977	26	27-80	21-70	1265	26
26-5	23-5	1245	26	27-80	33-70	1264	26
26-5	26-4	1106	26	27-82	20-71	1269	26
26-5	27-5	1105	26	27-82	32-71	1268	26
26-5	STP441	914	26	27-84	21-72	1273	26
26-5	STP445	921	26	27-84	33-72	1272	26
26-9	16-77	956	26	27-86	27-106	1007	26
26-11	16-79	962	26	27-106	27-86	1007	26
26-15	16-81	968	26	27-106	26-106	1146	26
26-17	16-83	974	26	27-106	28-106	1147	26
26-25	21-6	919	26	27-107	26-107	1219	26
26-27	20-7	919	26	27-107	28-107	1220	26
26-29	21-8	912	26	27-108	26-108	1229	26
26-31	20-9	912	26	27-108	28-108	1230	26
26-55	J4-N5	698	26	27-109	26-109	1235	26
26-57	J4-N1	692	26	27-109	28-109	1234	26
26-59	J4-N4	695	26	28-1	27-1	1100	26
26-75	20-65	1277	26	28-1	28-2	1099	26
26-75	23-108	1905	26	28-2	28-1	1099	26
26-106	23-106	1145	26	28-2	28-3	1098	26
26-106	27-106	1146	26	28-3	28-2	1098	26
26-107	27-107	1219	26	28-3	28-4	1097	26
26-108	27-108	1229	26	28-4	28-3	1097	26
26-109	27-109	1235	26	28-4	28-5	1096	26
27-1	28-1	1100	26	28-4	SPL94	864	26
27-1	27-2	1101	26	28-5	SPL65	565	26
27-2	27-1	1101	26	28-5	28-4	1096	26
				28-5	29-5	1095	26

## 3-31. MAJOR TEST ADAPTER (cont)

3-31

FROM	TO	WIRE ID	WIRE SIZE	FROM	TO	WIRE ID	WIRE SIZE
28-7	P1-D16	1463	26	28-101	28-106	1282	26
28-9	STP374	797	COAX	28-103	J3-S3	1896	26
28-11	STP376	799	COAX	28-105	J3-T2	1900	26
28-13	STP378	801	COAX	28-106	28-101	1282	26
28-15	STP380	803	COAX	28-106	28-71	1006	26
28-17	4-27	824	26	28-106	27-106	1147	26
28-19	4-29	828	26	28-106	29-106	1148	26
28-21	4-31	832	26	28-107	27-107	1220	26
28-23	4-33	836	26	28-107	29-107	1221	26
28-25	J3-P2	1873	26	28-108	27-108	1230	26
28-27	23-36	806	26	28-108	29-108	1231	26
28-29	23-38	810	26	28-109	27-109	1234	26
28-31	23-40	814	26	28-109	29-109	1233	26
28-33	23-42	818	26	29-1	29-2	1091	26
28-35	P1-K19	1402	26	29-2	29-1	1091	26
28-37	17-8	843	26	29-2	29-3	1092	26
28-39	17-10	849	26	29-3	29-2	1092	26
28-41	17-12	855	26	29-3	29-4	1093	26
28-43	17-14	861	26	29-4	29-3	1093	26
28-45	20-11	869	26	29-4	29-5	1094	26
28-47	J2-T2	554	24	29-4	SPL90	820	26
28-49	J2-T4	558	24	29-5	29-4	1094	26
28-51	J2-T6	562	26	29-5	28-5	1095	26
28-53	J2-S2	540	26	29-5	32-5	1246	26
28-55	J2-S4	544	26	29-5	STP166	368	26
28-57	P1-L23	1394	26	29-6	P1-Z14	366	26
28-59	P1-K15	1398	26	29-8	J6	797	COAX
28-63	P1-K24	1407	26	29-10	J8	799	COAX
28-65	P1-J14	1411	26	29-12	J10	801	COAX
28-67	P1-J18	1415	26	29-14	J12	803	COAX
28-69	P1-J23	1420	26	29-16	5-26	822	26
28-71	28-106	1006	26	29-18	5-28	826	26
28-73	J1-E6	1844	26	29-20	5-30	830	26
28-75	J1-F2	1849	26	29-22	5-32	834	26
28-77	J1-F4	1853	26	29-24	J3-P1	1871	26
28-79	J1-F6	1857	26	29-26	22-35	804	26
28-81	P1-J25	1422	26	29-28	22-37	808	26
28-83	P1-H17	1426	26	29-30	22-39	812	26
28-85	P1-H22	1430	26	29-32	22-41	816	26
28-87	P1-H26	1434	26	29-34	P1-K17	1400	26
28-89	P1-G16	1438	26	29-36	16-7	840	26
28-91	P1-G21	1442	26	29-38	16-9	846	26
28-93	P1-G25	1446	26	29-40	16-11	852	26
28-97	P1-E17	1451	26	29-42	16-13	858	26
28-99	P1-D18	1465	26	29-44	21-10	866	26
28-101	29-70	1281	26				

3-31. MAJOR TEST ADAPTER (cont)

FROM	TO	WIRE ID	WIRE SIZE	FROM	TO	WIRE ID	WIRE SIZE
29-46	J2-T1	552	24	32-5	33-5	1124	26
29-48	J2-T3	556	24	32-5	29-5	1246	26
29-50	J2-T5	560	26	32-5	SPL 61	531	26
29-52	J2-S1	538	26	32-7	STP373	796	26
29-54	J2-S3	542	26	32-9	STP375	798	COAX
29-56	P1-L21	1392	26	32-11	STP377	800	COAX
29-58	P1-L25	1396	26	32-13	STP379	802	COAX
29-62	P1-K22	1404	26	32-15	14-35	1776	26
29-64	P1-K26	1409	26	32-17	14-37	1780	26
29-66	P1-J16	1413	26	32-19	14-39	1784	26
29-68	P1-J21	1417	26	32-21	14-41	1789	26
29-70	28-101	1281	26	32-23	14-43	1793	26
29-72	J1-E5	1842	26	32-25	14-45	1797	26
29-74	J1-F1	1847	26	32-27	14-47	1801	26
29-76	J1-F3	1851	26	32-29	14-49	1806	26
29-78	J1-F5	1855	26	32-31	14-51	1810	26
29-80	J1-G1	1859	26	32-33	P1-E24	1457	26
29-82	P1-H15	1424	26	32-35	P1-D14	1461	26
29-84	P1-H19	1428	26	32-37	20-13	875	COAX
29-86	P1-H24	1432	26	32-39	20-15	881	26
29-88	P1-G14	1436	26	32-41	20-17	887	26
29-90	P1-G18	1440	26	32-43	20-19	895	26
29-92	P1-G23	1444	26	32-45	20-21	901	26
29-94	P1-E15	1448	26	32-47	J2-S6	550	26
29-96	P1-E19	1453	26	32-49	J2-R2	526	26
29-98	P1-E22	1455	26	32-51	J2-R4	532	26
29-100	P1-D21	1467	26	32-53	J2-R6	536	26
29-102	J3-S2	1894	26	32-55	J2-P6	522	26
29-104	J3-S4	1898	26	32-57	J1-G3	1864	26
29-106	28-106	1148	26	32-59	J1-G5	1868	26
29-106	32-106	1149	26	32-61	J3-P4	1877	26
29-107	28-107	1221	26	32-63	J1-C5	1817	26
29-107	32-107	1222	26	32-65	25-75	1276	26
29-108	28-108	1231	26	32-67	J3-P5	1879	26
29-108	29-109	1232	26	32-69	J3-R2	1883	26
29-109	29-108	1232	26	32-71	27-82	1268	26
29-109	28-109	1233	26	32-73	8-25	1687	26
31-93	STP350	742	26	32-75	8-27	1691	26
32-1	32-2	1128	26	32-77	8-29	1695	26
32-2	32-1	1128	26	32-79	8-31	1700	26
32-2	32-3	1127	26	32-81	8-33	1704	26
32-3	32-2	1127	26	32-83	8-35	1708	26
32-3	32-4	1126	26	32-85	J4-V3	743	26
32-4	32-3	1126	26	32-87	J4-V4	743	26
32-4	32-5	1125	26	32-89	J4-V1	740	26
32-4	SPL 96	890	26	32-91	J4-V2	740	26
32-4	SPL 98	904	26	32-93	32-106	1005	26
32-5	32-4	1125	26				

## 3-31. MAJOR TEST ADAPTER (cont)

3-31

FROM	TO	WIRE ID	WIRE SIZE	FROM	TO	WIRE ID	WIRE SIZE
32-93	STP352	745	26	33-42	21-18	892	26
32-95	J1-D2	1823	26	33-44	21-20	898	26
32-97	J1-D4	1827	26	33-46	J2-S5	546	26
32-99	J1-D6	1832	26	33-48	J2-R1	524	26
32-101	20-101	1253	26	33-50	J2-R3	528	26
32-101	J4-X5	1252	26	33-52	J2-R5	534	26
32-103	J1-E2	1836	26	33-54	J2-P5	520	26
32-105	J1-E4	1840	26	33-56	J1-G2	1862	26
32-106	32-93	1005	26	33-58	J1-G4	1866	26
32-106	29-106	1149	26	33-60	J3-P3	1875	26
32-106	33-106	1150	26	33-62	J1-C4	1815	26
32-107	29-107	1222	26	33-64	J1-C6	1819	26
32-107	33-107	1223	26	33-66	21-66	1296	26
32-108	33-108	1228	26	33-66	23-110	1907	26
32-109	33-109	1236	26	33-68	J3-R1	1881	26
32-110	33-110	1239	26	33-70	27-80	1264	26
33-1	34-1	1119	26	33-72	27-84	1272	26
33-1	33-2	1120	26	33-74	9-26	1689	26
33-2	33-1	1120	26	33-76	9-28	1693	26
33-2	33-3	1121	26	33-78	9-30	1697	26
33-3	33-2	1121	26	33-80	9-32	1702	26
33-3	33-4	1122	26	33-82	9-34	1706	26
33-4	33-3	1122	26	33-84	9-36	1710	26
33-4	33-5	1123	26	33-86	J3-R3	1885	26
33-5	33-4	1123	26	33-88	J3-R4	1888	26
33-5	32-5	1124	26	33-90	J3-R5	1890	26
33-5	SPL63	548	26	33-92	J3-S1	1892	26
33-6	J5	796	COAX	33-94	J1-D1	1821	26
33-8	J7	798	COAX	33-96	J1-D3	1825	26
33-10	J9	800	COAX	33-98	J1-D5	1829	26
33-12	J11	802	COAX	33-100	J4-Y6	1259	26
33-14	J13-HI	1300	26	33-100	21-100	1260	26
33-14	15-34	1774	26	33-102	J1-E1	1834	26
33-16	15-36	1778	26	33-104	J1-E3	1838	26
33-16	J13-LO	1301	26	33-106	32-106	1150	26
33-18	J13 GND	1302	26	33-106	34-106	1151	26
33-18	15-38	1782	26	33-107	32-107	1223	26
33-20	15-40	1786	26	33-107	34-107	1224	26
33-22	15-42	1791	26	33-108	32-108	1228	26
33-24	15-44	1795	26	33-108	34-108	1227	26
33-26	15-46	1799	26	33-109	32-109	1236	26
33-28	15-48	1804	26	33-109	34-109	1237	26
33-30	15-50	1808	26	33-110	32-110	1239	26
33-32	15-52	1812	26	33-110	34-110	1240	26
33-34	P1-E26	1459	26	34-1	33-1	1119	26
33-36	21-12	872	26	34-1	34-2	1118	26
33-38	21-14	878	26	34-2	34-1	1118	26
33-40	21-16	884	26				

## 3-31. MAJOR TEST ADAPTER (cont)

FROM	TO	WIRE ID	WIRE SIZE	FROM	TO	WIRE ID	WIRE SIZE
34-2	34-3	1117	26	34-110	35-110	1241	26
34-3	34-2	1117	26	35-1	35-2	1110	26
34-3	34-4	1116	26	35-2	35-1	1110	26
34-4	34-3	1116	26	35-2	35-3	1111	26
34-4	34-5	1115	26	35-3	35-2	1111	26
34-5	34-4	1115	26	35-3	35-4	1112	26
34-5	35-5	1114	26	35-4	35-3	1112	26
34-106	33-106	1151	26	35-4	35-5	1113	26
34-106	35-106	1152	26	35-5	35-4	1113	26
34-107	33-107	1224	26	35-5	34-5	1114	26
34-107	35-107	1225	26	35-106	34-106	1152	26
34-108	33-108	1227	26	35-107	34-107	1225	26
34-108	35-108	1226	26	35-108	34-108	1226	26
34-109	33-109	1237	26	35-109	34-109	1238	26
34-109	35-109	1238	26	35-110	34-110	1241	26
34-110	33-110	1240	26				

3-32. TPS CABLE ASSEMBLIES

The data contained in this paragraph provides the wire list for the cable assemblies that connect between the UUT and EETF TADS/PNVS Augmentation Equipment during UUT testing. The cable assemblies are listed in numerical order according to part number.

	Page
TPS Cable Assembly 13081448 Wire List . . . . .	3-381
TPS Cable Assembly 13081454-29 Wire Diagram . . . . .	3-382
TPS Cable Assembly 13081706-39 Wire Diagram . . . . .	3-382
TPS Cable Assembly 13081706-49 Wire Diagram . . . . .	3-382
TPS Cable Assembly 13081706-59 Wire Diagram . . . . .	3-382
TPS Cable Assembly 13081706-79 Wire Diagram . . . . .	3-382
TPS Cable Assembly 13081706-89 Wire Diagram . . . . .	3-382
TPS Cable Assembly 13082466 Wire List . . . . .	3-383
TPS Cable Assembly 13082485 Wire List . . . . .	3-393
TPS Cable Assembly 13082730 Wire List . . . . .	3-409
TPS Cable Assembly 13083226 Wire List . . . . .	3-425
TPS Cable Assembly 13083693-19 Wire List . . . . .	3-459
TPS Cable Assembly 13083693-29 Wire List . . . . .	3-464
TPS Cable Assembly 13083701 Wire List . . . . .	3-490
TPS Cable Assembly 13083708 Wire List . . . . .	3-502
TPS Cable Assembly 13083728 Wire List . . . . .	3-533
TPS Cable Assembly 13083733 Wire List . . . . .	3-557
TPS Cable Assembly 13231064 Wire List . . . . .	3-560
TPS Cable Assembly 13231435 Wire Diagram . . . . .	3-560.2
TPS Cable Assembly 13231464 Wire List . . . . .	3-560.3
TPS Cable Assembly 13241470 Wire List . . . . .	3-560.8
TPS Cable Assembly 13231473 Wire List . . . . .	3-560.15
TPS Cable Assembly 13231512 Wire List . . . . .	3-560.17
TPS Cable Assembly 13231598 Wire List . . . . .	3-560.26
TPS Cable Assembly 13231655 Wire List . . . . .	3-560.27
TPS Cable Assembly 13082831-509 Wire List . . . . .	3-560.29
TPS Cable Assembly 13231735 Wire List . . . . .	3-560.47
TPS Cable Assembly 13231959 Wire List . . . . .	3-560.67





3-32. TPS CABLE ASSEMBLIES (cont)

3-32

CABLE ASSEMBLY 13081448 WIRE LIST

FROM	TO	WIRE ID	WIRE SIZE	FROM	TO	WIRE ID	WIRE SIZE
P1-p	STMB	29		P2-5	P1-KK	4	22
P1-q	P2-25	26		P2-7	P1-HH	8	
P1-r	P2-24	25		P2-8	P1-GG	9	22
P1-s	STMA	28		P2-10	P1-FF	10	22
P1-t	P2-22	22	22	P2-11	P1-DD	12	
P1-u	P2-21	22	22	P2-12	P1-CC	13	
P1-v	P2-20	21		P2-13	P1-BB	14	
P1-w	P2-19	18	22	P2-14	P1-AA	15	
P1-x	P2-18	18	22	P2-15	P1-z	16	
P1-y	P2-17	17		P2-16	STMC	27	
P1-z	P2-15	16		P2-17	P1-y	17	
P1-AA	P2-14	15		P2-18	P1-x	18	22
P1-BB	P2-13	14		P2-19	P1-w	18	22
P1-CC	P2-12	13		P2-20	P1-v	21	
P1-DD	P2-11	12		P2-21	P1-u	22	22
P1-EE	STP3	11		P2-22	P1-t	22	22
P1-FF	P2-10	10	22	P2-24	P1-r	25	
P1-GG	P2-8	9	22	P2-25	P1-q	26	
P1-HH	P2-7	8		STMA	STP4	19	
P1-JJ	STP2	7		STMA	STP5	23	
P1-KK	P2-5	4	22	STMA	P1-s	28	
P1-LL	P2-4	4	22	STMB	P1-p	29	
P1-MM	STP1	2		STMC	P2-16	27	
P1-NN	P2-2	1	22	STP1	P1-MM	2	
P1-PP	P2-1	1	22	STP2	P1-JJ	7	
P2-1	P1-PP	1	22	STP3	P1-EE	11	
P2-2	P1-NN	1	22	STP4	STMA	19	
P2-4	P1-LL	4	22	STP5	STMA	23	

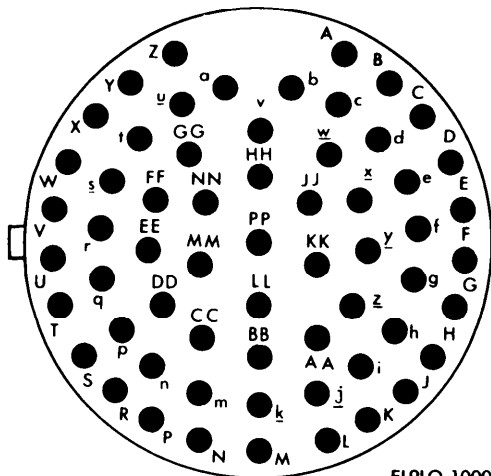

EL9LQ-1000-65B

P1-PT06SE-24-61PW (SR)

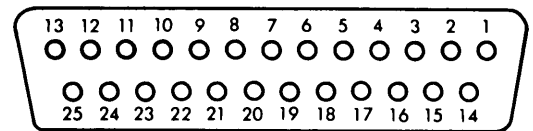

EL9LQ-1000-11

P2-M24308/2-3F

CABLE ASSEMBLY 13081454-29 WIRE DIAGRAM

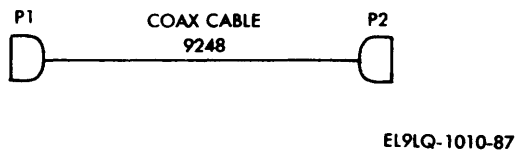

CABLE ASSEMBLY 13081706-79 AND 13081706-89 WIRE DIAGRAM

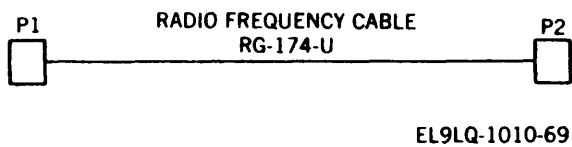

CABLE ASSEMBLY 13081706-39, 13081706-49, AND 13081706-59 WIRE DIAGRAM

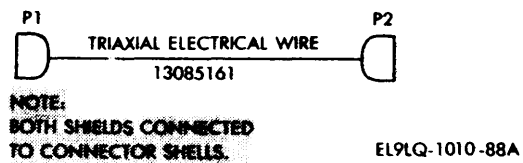

3-32. TPS CABLE ASSEMBLIES (cont)

CABLE ASSEMBLY 13082466 WIRE LIST

FROM	TO	WIRE ID	WIRE SIZE	FROM	TO	WIRE ID	WIRE SIZE
P1-A1	P2-D	11	26	P2-A	P1-A4	2	26
P1-A2	P2-C	10	26	P2-A	P2-E	3	26
P1-A3	P2-B	9	26	P2-B	P1-A3	9	26
P1-A4	P1-G7	1	26	P2-C	P1-A2	10	26
P1-A4	P2-A	2	26	P2-D	P1-A1	11	26
P1-A5	P1-G8	7	26	P2-E	P1-B1	4	26
P1-A5	P2-N	8	26	P2-E	P2-A	3	26
P1-A6	P2-H	14	26	P2-E	P2-J	5	26
P1-A7	P2-G	13	26	P2-F	P1-A8	12	26
P1-A8	P2-F	12	26	P2-G	P1-A7	13	26
P1-B1	P2-E	4	26	P2-H	P1-A6	14	26
P1-B2	P2-P	18	26	P2-J	P1-B6	6	26
P1-B3	P2-M	17	26	P2-J	P2-E	5	26
P1-B4	P2-L	16	26	P2-K	P1-B5	15	26
P1-B5	P2-K	15	26	P2-L	P1-B4	16	26
P1-B6	P2-J	6	26	P2-M	P1-B3	17	26
P1-B7	P2-R	19	26	P2-N	P1-A5	8	26
P1-B8	P2-X	25	26	P2-P	P1-B2	18	26
P1-C1	P2-W	24	26	P2-R	P1-B7	19	26
P1-C2	P2-V	23	26	P2-S	P1-C4	20	26
P1-C3	P2-U	22	26	P2-T	P1-C5	21	26
P1-C4	P2-S	20	26	P2-U	P1-C3	22	26
P1-C5	P2-T	21	26	P2-V	P1-C2	23	26
P1-G7	P1-A4	1	26	P2-W	P1-C1	24	26
P1-G8	P1-A5	7	26	P2-X	P1-B8	25	26

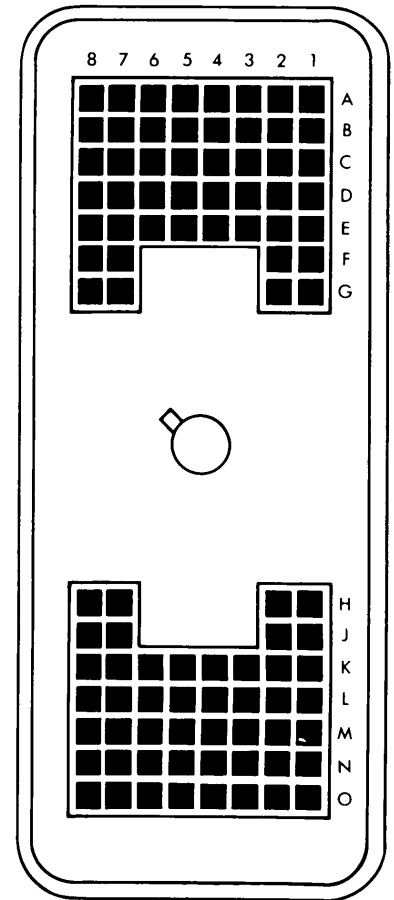

EL9LQ-1000-85 A

P1-DL2-96P



CABLE ASSEMBLY 13082485 WIRE LIST

FROM	TO	WIRE ID	WIRE SIZE	FROM	TO	WIRE ID	WIRE SIZE
GND	P3-2	44	24	P2-D1	P3-5	37	24
GND	P3-4	46	24	P2-D3	P3-6	38	24
P1-A1	P3-14	1	24	P2-D5	P3-22	39	24
P1-A3	P3-15	2	24	P2-E1	P3-23	40	24
P1-A5	P1-N3	3	24	P2-E3	P3-24	41	24
P1-B1	P2-T3	5	24	P2-E5	P3-1	42	24
P1-B3	P1-N1	9	24	P2-F1	P3-2	43	24
P1-B5	P1-N4	11	24	P2-S5	P3-3	47	24
P1-C1	P1-N5	13	24	P2-T1	P3-4	45	24
P1-C3	P1-N6	15	24	P2-T3	P1-B1	5	24
P1-C5	P1-M1	17	24	P2-T3	P1-N2	6	24
P1-D1	P3-8	25	24	P2-T5	P3-28	48	24
P1-D3	P3-9	26	24	P2-U1	P3-29	49	24
P1-D5	P3-10	27	24	P2-U3	P3-31	50	24
P1-E1	P3-11	28	24	P2-U5	P3-20	51	24
P1-E3	P3-12	29	24	P2-V1	P3-21	52	24
P1-E5	P3-13	30	24	P3-1	P2-E5	42	24
P1-F1	P3-19	31	24	P3-2	P2-F1	43	24
P1-M1	P1-C5	17	24	P3-2	GND	44	24
P1-M1	P3-35	18	24	P3-3	P2-S5	47	24
P1-M2	P3-25	19	24	P3-4	GND	46	24
P1-M3	P3-26	20	24	P3-4	P2-T1	45	24
P1-M4	P3-27	21	24	P3-5	P2-D1	37	24
P1-M5	P1-M6	22	24	P3-6	P2-D3	38	24
P1-M5	P3-30	23	24	P3-7	P2-C5	36	24
P1-M6	P1-M5	22	24	P3-8	P1-D1	25	24
P1-N1	P3-18	10	24	P3-9	P1-D3	26	24
P1-N1	P1-B3	9	24	P3-10	P1-D5	27	24
P1-N2	P2-T3	6	24	P3-11	P1-E1	28	24
P1-N2	P3-17	7	24	P3-12	P1-E3	29	24
P1-N3	P1-A5	3	24	P3-13	P1-E5	30	24
P1-N3	P3-16	4	24	P3-14	P1-A1	1	24
P1-N4	P1-B5	11	24	P3-15	P1-A3	2	24
P1-N4	P3-32	12	24	P3-16	P1-N3	4	24
P1-N5	P1-C1	13	24	P3-17	P1-N2	7	24
P1-N5	P3-33	14	24	P3-17	P3-30	8	24
P1-N6	P1-C3	15	24	P3-18	P1-N1	10	24
P1-N6	P3-34	16	24	P3-19	P1-F1	31	24
P2-C5	P3-7	36	24	P3-20	P2-U5	51	24

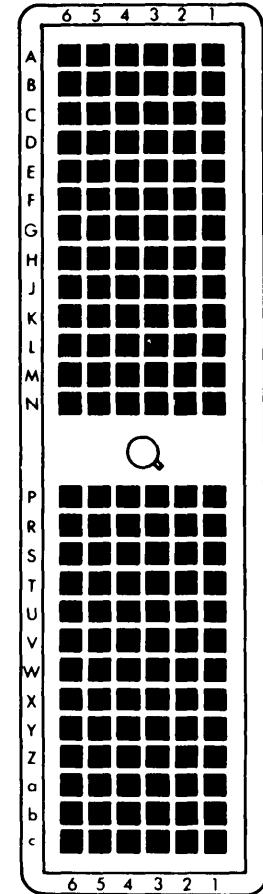

EL9LQ-1000-82A

P1 and P2 - DL1-156P

3-32. TPS CABLE ASSEMBLIES (cont)

CABLE ASSEMBLY 13082485 WIRE LIST (cont)

FROM	TO	WIRE ID	WIRE SIZE
P3-21	P2-V1	52	24
P3-22	P2-D5	39	24
P3-23	P2-E1	40	24
P3-24	P2-E3	41	24
P3-25	P1-M2	19	24
P3-26	P1-M3	20	24
P3-27	P1-M4	21	24
P3-28	P2-T5	48	24
P3-29	P2-U1	49	24
P3-30	P1-M5	23	24
P3-30	P3-17	8	24
P3-31	P2-U3	50	24
P3-32	P1-N4	12	24
P3-33	P1-N5	14	24
P3-34	P1-N6	16	24
P3-35	P1-M1	18	24

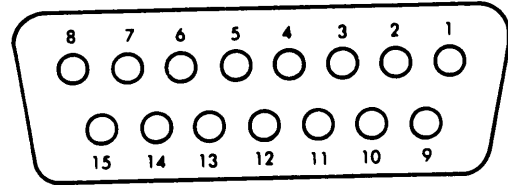

EL9LQ-1000-5

P3 - M24308/2-4

3-32. TPS CABLE ASSEMBLIES (cont)

CABLE ASSEMBLY 13082730 WIRE LIST

FROM	TO	WIRE ID	WIRE SIZE	FROM	TO	WIRE ID	WIRE SIZE
P1-A1	P3-A1	1	24	P1-H2	P6-P	87	24
P1-A2	P3-A2	2	24	P1-H3	P6-M	86	24
P1-A3	P3-A3	3	24	P1-H4	P6-N	86	24
P1-A4	P3-A4	4	24	P1-H5	P6-L	85	24
P1-A5	P3-A5	5	24	P1-H6	P6-J	85	24
P1-A6	P3-A6	6	24	P1-J3	P6-e	89	24
P1-B1	P3-A7	7	24	P1-J4	P6-c	89	24
P1-B2	P3-A8	8	24	P1-J5	P6-Y	88	24
P1-B3	P3-B1	11	24	P1-J6	P6-W	88	24
P1-B4	P3-B2	12	24	P1-L1	P5-c	82	24
P1-B5	P3-B3	13	24	P1-L2	P5-e	82	24
P1-B6	P3-B4	14	24	P1-M1	P7-J	90	24
P1-C1	P3-B5	15	24	P1-M2	P7-K	90	24
P1-C2	P3-B6	16	24	P1-M3	P4-A	75	24
P1-C3	P3-B7	17	24	P1-M4	P4-B	75	24
P1-C4	P3-B8	18	24	P1-M5	P4-F	77	24
P1-C5	SPL1	9	24	P1-M6	P4-G	77	24
P1-C6	SPL3	19	24	P1-N1	P5-H	79	24
P1-D1	SPL5	29	24	P1-N2	P5-K	79	24
P1-D2	SPL7	39	24	P1-N3	P5-P	80	24
P1-D3	SPL28	161	24	P1-N4	P5-S	80	24
P1-D4	SPL11	59	24	P1-N5	P5-W	81	24
P1-D5	SPL17	83	24	P1-N6	P5-Y	81	24
P1-D6	SPL19	92	24	P1-P1	P3-K1	41	24
P1-E1	P3-C1	21	24	P1-P2	P3-K2	42	24
P1-E2	P3-C2	22	24	P1-P3	P3-K3	43	24
P1-E3	P3-C3	23	24	P1-P4	P3-K4	44	24
P1-E4	P3-C4	24	24	P1-P5	P3-K5	45	24
P1-E5	P3-C5	25	24	P1-P6	P3-K6	46	24
P1-E6	P3-C6	26	24	P1-R1	P3-K7	47	24
P1-F1	P3-C7	27	24	P1-R2	P3-K8	48	24
P1-F2	P3-C8	28	24	P1-R3	P3-N1	51	24
P1-F3	P3-D1	31	24	P1-R4	P3-N2	52	24
P1-F4	P3-D2	32	24	P1-R5	P3-N3	53	24
P1-F5	P3-D3	33	24	P1-R6	P3-N4	54	24
P1-F6	P3-D4	34	24	P1-S1	P3-N5	55	24
P1-G1	P3-D5	35	24	P1-S2	P3-N6	56	24
P1-G2	P3-D6	36	24				
P1-G3	P3-D7	37	24				
P1-G4	P3-D8	38	24				
P1-G5	P6-K	84	24				
P1-G6	P6-H	84	24				
P1-H1	P6-S	87	24				

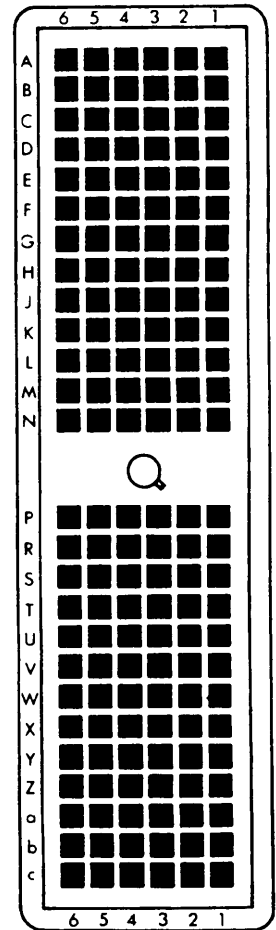

EL9LQ-1000-82A

**P1-13081528-1**  
**P2-DL1-156P**



3-32. TPS CABLE ASSEMBLIES (cont)

CABLE ASSEMBLY 13082730 WIRE LIST (cont)

FROM	TO	WIRE ID	WIRE SIZE	FROM	TO	WIRE ID	WIRE SIZE
P1-S3	P3-N7	57	24	P1-X3	SPL37	148	24
P1-S4	P3-N8	58	24	P1-X4	P3-M5	171	24
P1-S5	SPL26	106	24	P1-X5	P3-M4	170	24
P1-S6	SPL26	107	24	P1-X6	P3-M3	170	24
P1-SPL33	P12-SPL35	137	24	P1-Y1	SPL38	149	24
P1-SPL34	P12-SPL36	137	24	P1-Y2	SPL38	150	24
P1-SPL37	P13-SPL39	152	24	P1-Y3	SPL38	151	24
P1-SPL38	P13-SPL59	152	24	P1-Y4	P3-M8	172	24
P1-T1	P9-D	111	24	P1-Y5	P3-M7	172	24
P1-T2	P9-E	111	24	P1-Y6	P3-M6	171	24
P1-T3	P10-D	122	24	P1-Z2	P14-F	166	24
P1-T4	P10-E	122	24	P1-Z3	P14-G	166	24
P1-T5	SPL27	109	24	P1-Z4	P14-H	167	24
P1-T6	SPL27	110	24	P1-Z5	P14-A	162	24
P1-U1	SPL29	112	24	P1-Z6	P14-B	162	24
P1-U2	SPL29	113	24	P1-a3	P14-J	167	24
P1-U3	SPL30	115	24	P1-a4	SPL43	168	24
P1-U4	SPL30	116	24	P1-a5	P14-C	163	24
P1-U5	SPL33	127	24	P1-a6	P14-D	163	24
P1-U6	SPL33	128	24	P1-b1	SPL24	99	24
P1-V1	P11-E	125	24	P1-b2	SPL24	100	24
P1-V2	P11-F	125	24	P1-b3	SPL25	102	24
P1-V3	P11-A	126	24	P1-b4	SPL25	103	24
P1-V4	P11-B	126	24	P1-b5	SPL20	104	24
P1-V5	SPL33	129	24	P1-b6	SPL41	164	24
P1-V6	SPL33	130	24	P1-c1	P8-A	93	20
P1-W1	SPL34	132	24	P1-c2	P8-B	93	20
P1-W2	SPL34	133	24	P1-c3	SPL22	94	24
P1-W3	SPL34	134	24	P1-c4	SPL22	95	24
P1-W4	SPL34	135	24	P1-c5	SPL23	97	24
P1-W5	SPL34	136	24	P1-c6	SPL23	98	24
P1-W6	SPL33	131	24				
P1-X1	SPL37	146	24				
P1-X2	SPL37	147	24				

CABLE ASSEMBLY 13082730 WIRE LIST (cont)

FROM	TO	WIRE ID	WIRE SIZE
P2-D4	SPL-13	69	24
P2-D6	SPL-15	124	24
P2-L3	P3-M1	71	24
P2-L4	P3-M2	72	24
P2-M1	P7-J	91	24
P2-M2	P7-K	91	24
P2-M3	P4-A	76	24
P2-M4	P4-B	76	24
P2-M5	P4-F	77	24
P2-M6	P4-G	77	24
P2-R3	P3-L1	61	24
P2-R4	P3-L2	62	24
P2-R5	P3-L3	63	24
P2-R6	P3-L4	64	24
P2-S1	P3-L5	65	24
P2-S2	P3-L6	66	24
P2-S3	P3-L7	67	24
P2-S4	P3-L8	68	24
P2-T3	P10-D	123	24
P2-T4	P10-E	123	24
P2-U1	SPL31	117	24
P2-U2	SPL31	118	24
P2-U3	SPL32	120	24
P2-U4	SPL32	121	24

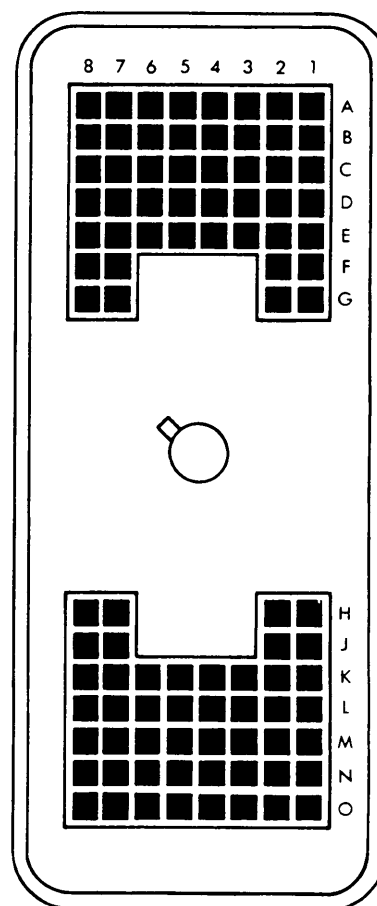

EL9LQ-1000-85 A

P3-13081528-2



3-32. TPS CABLE ASSEMBLIES (cont)

3-32

CABLE ASSEMBLY 13082730 WIRE LIST (cont)

FROM	TO	WIRE ID	WIRE SIZE	FROM	TO	WIRE ID	WIRE SIZE
P3	P1	172	24	P3-E8	SPL16	74	24
P3-A1	P1-A1	1	24	P3-K1	P1-P1	41	24
P3-A2	P1-A2	2	24	P3-K2	P1-P2	42	24
P3-A3	P1-A3	3	24	P3-K3	P1-P3	43	24
P3-A4	P1-A4	4	24	P3-K4	P1-P4	44	24
P3-A5	P1-A5	5	24	P3-K5	P1-P5	45	24
P3-A6	P1-A6	6	24	P3-K6	P1-P6	46	24
P3-A7	P1-B1	7	24	P3-K7	P1-R1	47	24
P3-A8	P1-B2	8	24	P3-K8	P1-R2	48	24
P3-B1	P1-B3	11	24	P3-L1	P2-R3	61	24
P3-B2	P1-B4	12	24	P3-L2	P2-R4	62	24
P3-B3	P1-B5	13	24	P3-L3	P2-R5	63	24
P3-B4	P1-B6	14	24	P3-L4	P2-R6	64	24
P3-B5	P1-C1	15	24	P3-L5	P2-S1	65	24
P3-B6	P1-C2	16	24	P3-L6	P2-S2	66	24
P3-B7	P1-C3	17	24	P3-L7	P2-S3	67	24
P3-B8	P1-C4	18	24	P3-L8	P2-S4	68	24
P3-C1	P1-E1	21	24	P3-M1	P1-L3	71	24
P3-C2	P1-E2	22	24	P3-M2	P1-L4	72	24
P3-C3	P1-E3	23	24	P3-M3	P1-X6	170	24
P3-C4	P1-E4	24	24	P3-M4	P1-X5	170	24
P3-C5	P1-E5	25	24	P3-M5	P1-X4	171	24
P3-C6	P1-E6	26	24	P3-M6	P1-Y6	171	24
P3-C7	P1-F1	27	24	P3-M7	P1-Y5	172	24
P3-C8	P1-F2	28	24	P3-M8	P1-Y4	172	24
P3-D1	P1-F3	31	24	P3-N1	P1-R3	51	24
P3-D2	P1-F4	32	24	P3-N2	P1-R4	52	24
P3-D3	P1-F5	33	24	P3-N3	P1-R5	53	24
P3-D4	P1-F6	34	24	P3-N4	P1-R6	54	24
P3-D5	P1-G1	35	24	P3-N5	P1-S1	55	24
P3-D6	P1-G2	36	24	P3-N6	P1-S2	56	24
P3-D7	P1-G3	37	24	P3-N7	P1-S3	57	24
P3-D8	P1-G4	38	24	P3-N8	P1-S4	58	24
P3-E1	SPL2	10	24	P4	OPEN	75	
P3-E2	SPL4	20	24	P4-A	P1-M3	75	24
P3-E3	SPL6	30	24	P4-A	P2-M3	76	24
P3-E4	SPL8	40	24	P4-B	P1-M4	75	24
P3-E5	SPL10	50	24	P4-B	P2-M4	76	24
P3-E6	SPL12	60	24	P4-F	P1-M5	77	24
P3-E7	SPL14	70	24	P4-F	P2-M5	78	24
				P4-G	P1-M6	77	24

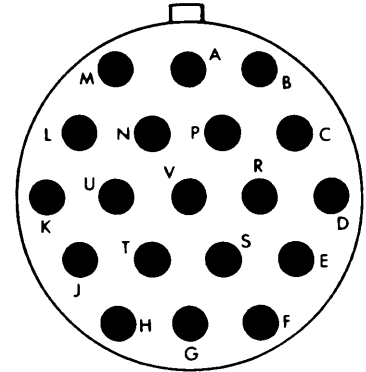

EL9LQ-1000-15

**P4 - MS3126F14-19P**

CABLE ASSEMBLY 13082730 WIRE LIST (cont)

FROM	TO	WIRE ID	WIRE SIZE
P4-G	P2-M6	78	24
P5	OPEN	79	
P5-H	P1-N1	79	24
P5-K	P1-N2	79	24
P5-P	P1-N3	80	24
P5-S	P1-N4	80	24
P5-W	P1-N5	81	24
P5-Y	P1-N6	81	24
P5-c	P1-L1	82	24
P5-e	P1-L2	82	24
P6	OPEN	84	
P6-H	P1-G6	84	24
P6-J	P1-H6	85	24
P6-K	P1-G5	84	24
P6-L	P1-H5	85	24
P6-M	P1-H3	86	24
P6-N	P1-H4	86	24
P6-P	P1-H2	87	24
P6-S	P1-H1	87	24
P6-W	P1-J6	88	24
P6-Y	P1-J5	88	24
P6-c	P1-J4	89	24
P6-e	P1-J3	89	24
P7	OPEN	90	
P7-J	P1-M1	90	24
P7-J	P2-M1	91	24
P7-K	P1-M2	90	24
P7-K	P2-M2	91	24
P8	STP134	93	20
P8	STP136	98	20
P8	STP138	103	20
P8-A	P1-c1	93	20
P8-B	P1-c2	93	20

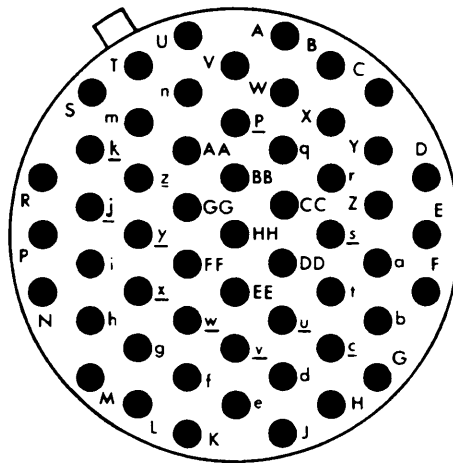

EL9LQ-1000-43A

P5 - MS3126F22-55PW

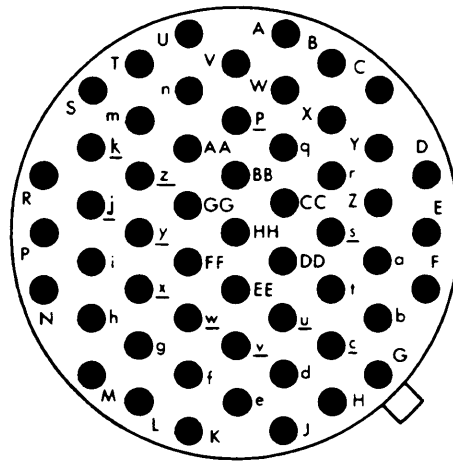

EL9LQ-1000-44

P6 - MS3126F22-55PY

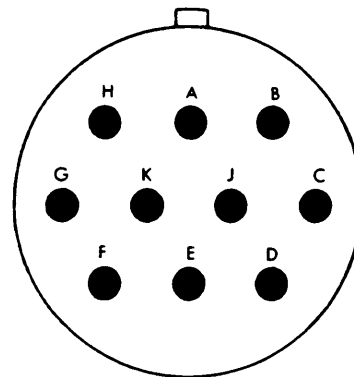

EL9LQ-1000-14

P7 - MS3126F12-10P

CABLE ASSEMBLY 13082730 WIRE LIST (cont)

FROM	TO	WIRE ID	WIRE SIZE
P8-G	SPL21	105	24
P8-J	SPL22	96	14
P8-K	SPL23	98	24
P8-L	SPL24	101	14
P8-M	SPL25	103	24
P9	OPEN	110	
P9-A	SPL26	108	18
P9-B	SPL27	110	18
P9-D	P1-T1	111	20
P9-E	P1-T2	111	20
P10	OPEN	116	
P10-A	SPL45	173	18
P10-B	SPL46	174	18
P10-D	P1-T3	122	20
P10-D	P2-T3	123	20
P10-E	P1-T4	122	20
P10-E	P2-T4	123	20
P11	OPEN	125	
P11-A	P1-V3	126	24
P11-B	P1-V4	126	24
P11-E	P1-V1	125	24
P11-F	P1-V2	125	24
P12	OPEN	145	
P12-A	SPL35	138	24
P12-B	SPL35	139	24
P12-C	SPL35	140	24
P12-D	SPL35	141	24
P12-F	SPL36	142	24
P12-G	SPL36	143	24
P12-H	SPL36	144	24
P12-J	SPL36	145	24
P12-SPL35	P1-SPL33	137	24
P12-SPL36	P1-SPL34	137	24
P13	OPEN	160	
P13-A	SPL39	153	24
P13-B	SPL39	154	24
P13-C	SPL39	155	24
P13-D	SPL39	156	12

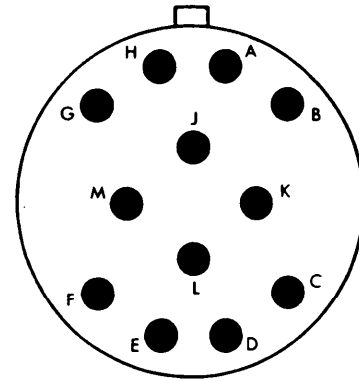

EL9LQ-1000-17

P8 - MS3126F14-12P

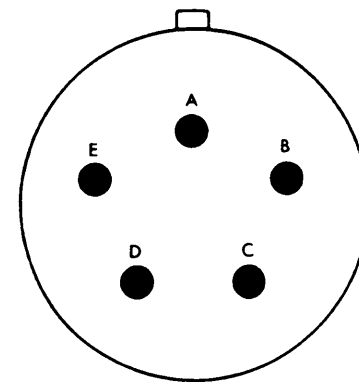

EL9LQ-1000-18

P9 and P10 - MS3126F14-5P

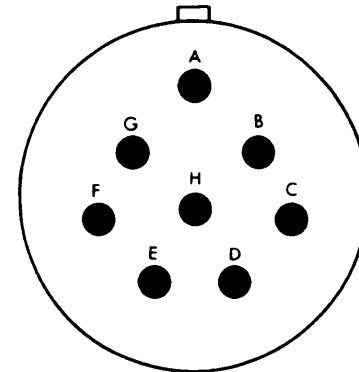

EL9LQ-1000-19

P11 - MS3126F16-8P

CABLE ASSEMBLY 13082730 WIRE LIST (cont)

FROM	TO	WIRE ID	WIRE SIZE	FROM	TO	WIRE ID	WIRE SIZE
P13-E	SPL40	160	24	SPL2	STP8	4	24
P13-F	SPL40	157	24	SPL2	STP10	5	24
P13-G	SPL40	158	24	SPL2	STP12	6	24
P13-H	SPL40	159	24	SPL2	STP14	7	24
P3-SPL39	P1-SPL37	152	24	SPL2	STP16	8	24
P3-SPL40	P1-SPL38	152	24	SPL3	P1-C6	19	24
P14	STP150	162	24	SPL3	STP17	11	24
P14	STP152	163	24	SPL3	STP19	12	24
P14	STP154	166	24	SPL3	STP21	13	24
P14	STP156	167	24	SPL3	STP23	14	24
P14-A	P1-Z5	162	24	SPL3	STP25	15	24
P14-B	P1-Z6	162	24	SPL3	STP27	16	24
P14-C	P1-a5	163	24	SPL3	STP29	17	24
P14-D	P1-a6	163	24	SPL3	STP31	18	24
P14-E	SPL42	165	24	SPL4	P3-E2	20	24
P14-F	P1-Z2	166	24	SPL4	STP18	11	24
P14-G	P1-Z3	166	24	SPL4	STP20	12	24
P14-H	P1-Z4	167	24	SPL4	STP22	13	24
P14-J	P1-a3	167	24	SPL4	STP24	14	24
P14-K	SPL44	169	24	SPL4	STP26	15	24
SPL1	P1-C5	9	24	SPL4	STP28	16	24
SPL1	STP1	1	24	SPL4	STP30	17	24
SPL1	STP3	2	24	SPL4	STP32	18	24
SPL1	STP5	3	24	SPL5	STP33	21	24
SPL1	STP7	4	24	SPL5	STP35	22	24
SPL1	STP9	5	24	SPL5	STP37	23	24
SPL1	STP11	6	24	SPL5	STP39	24	24
SPL1	STP13	7	24				
SPL1	STP15	8	24				
SPL2	P3-E1	10	24				
SPL2	STP2	1	24				
SPL2	STP4	2	24				
SPL2	STP6	3	24				

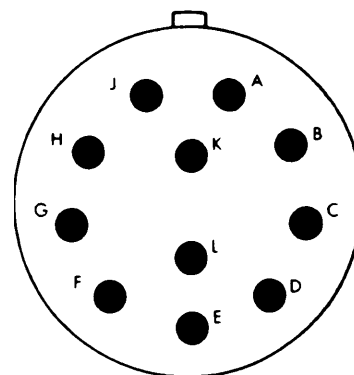

EL9LQ-1000-48

P12 and P13 - MS3126F18-11P

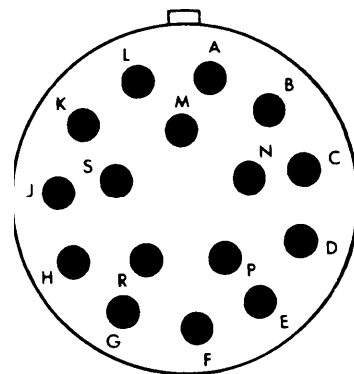

EL9LQ-1000-89

P14 - MS3126F20-16P

## 3-32. TPS CABLE ASSEMBLIES (cont)

3-32

## CABLE ASSEMBLY 13082730 WIRE LIST (cont)

FROM	TO	WIRE ID	WIRE SIZE	FROM	TO	WIRE ID	WIRE SIZE
SPL5	STP41	25	24	SPL10	STP68	42	24
SPL5	STP43	26	24	SPL10	STP70	43	24
SPL5	STP45	27	24	SPL10	STP72	44	24
SPL5	STP47	28	24	SPL10	STP74	45	24
SPL5	P1-D1	29	24	SPL10	STP76	46	24
SPL6	STP34	21	24	SPL10	STP78	47	24
SPL6	STP36	22	24	SPL10	STP80	48	24
SPL6	STP38	23	24	SPL10	P3-E5	50	24
SPL6	STP40	24	24	SPL11	STP81	51	24
SPL6	STP42	25	24	SPL11	STP83	52	24
SPL6	STP44	26	24	SPL11	STP85	53	24
SPL6	STP46	27	24	SPL11	STP87	54	24
SPL6	STP48	28	24	SPL11	STP89	55	24
SPL6	P3-E3	30	24	SPL11	STP91	56	24
SPL7	STP49	31	24	SPL11	STP93	57	24
SPL7	STP51	32	24	SPL11	STP95	58	24
SPL7	STP53	33	24	SPL11	P1-D4	59	24
SPL7	STP55	34	24	SPL12	STP82	51	24
SPL7	STP57	35	24	SPL12	STP84	52	24
SPL7	STP59	36	24	SPL12	STP86	53	24
SPL7	STP61	37	24	SPL12	STP88	54	24
SPL7	STP63	38	24	SPL12	STP90	55	24
SPL7	P1-D2	39	24	SPL12	STP92	56	24
SPL8	STP50	31	24	SPL12	STP94	57	24
SPL8	STP52	32	24	SPL12	STP96	58	24
SPL8	STP54	33	24	SPL12	P3-E6	60	24
SPL8	STP56	34	24	SPL13	STP97	61	24
SPL8	STP58	35	24	SPL13	STP99	62	24
SPL8	STP60	36	24	SPL13	STP101	63	24
SPL8	STP62	37	24	SPL13	STP103	64	24
SPL8	STP64	38	24	SPL13	STP105	65	24
SPL8	P3-E4	39	24	SPL13	STP107	66	24
SPL9	STP65	41	24	SPL13	STP109	67	24
SPL9	STP67	42	24	SPL13	STP111	68	24
SPL9	STP69	43	24	SPL13	P2-D4	69	24
SPL9	STP71	44	24	SPL14	STP98	61	24
SPL9	STP73	45	24	SPL14	STP100	62	24
SPL9	STP75	46	24	SPL14	STP102	63	24
SPL9	STP77	47	24	SPL14	STP104	64	24
SPL9	STP79	48	24	SPL14	STP106	65	24
SPL9	SPL28	49	24	SPL14	STP108	66	24
SPL10	STP66	41	24	SPL14	STP110	67	24



CABLE ASSEMBLY 13082730 WIRE LIST (cont)

FROM	TO	WIRE ID	WIRE SIZE	FROM	TO	WIRE ID	WIRE SIZE
SPL14	STP112	68	24	SPL24	P1-b1	99	24
SPL14	P3-E7	69	24	SPL24	P1-b2	100	24
SPL15	STP113	71	24	SPL24	P8-L	101	24
SPL15	STP115	72	24	SPL25	P1-b3	102	24
SPL15	STP118	76	24	SPL25	P1-b4	103	24
SPL15	STP120	78	24	SPL25	P8-M	103	24
SPL15	STP132	91	24	SPL26	P1-S5	106	24
SPL15	STP142	121	20	SPL26	P1-S6	107	24
SPL15	STP144	123	24	SPL26	P9-A	108	18
SPL15	P2-D6	124	18	SPL27	P1-T5	109	24
SPL16	STP114	71	24	SPL27	P1-T6	110	24
SPL16	STP116	72	24	SPL27	P9-B	110	24
SPL16	P3-E8	74	24	SPL28	SPL9	49	24
SPL17	STP117	75	24	SPL28	STP139	110	24
SPL17	STP119	77	24	SPL28	STP140	111	20
SPL17	STP121	79	24	SPL28	STP141	116	18
SPL17	STP122	80	24	SPL28	STP143	122	20
SPL17	STP123	81	24	SPL28	STP145	125	24
SPL17	STP124	82	24	SPL28	STP146	126	24
SPL17	P1-D5	83	24	SPL28	STP147	145	24
SPL19	STP125	84	24	SPL28	STP148	160	24
SPL19	STP126	85	24	SPL28	P1-D3	161	24
SPL19	STP127	86	24	SPL29	P1-U1	112	24
SPL19	STP128	87	24	SPL29	P1-U2	113	24
SPL19	STP129	88	24	SPL29	SPL45	114	24
SPL19	STP130	89	24	SPL30	P1-U3	115	24
SPL19	STP131	90	24	SPL30	P1-U4	116	24
SPL19	P1-D6	92	24	SPL30	SPL46	116	18
SPL20	STP133	93	24	SPL31	P2-U1	117	24
SPL20	STP135	98	24	SPL31	P2-U2	118	24
SPL20	STP137	103	24	SPL31	SPL45	119	18
SPL20	P1-b5	104	24	SPL32	P2-U3	120	24
SPL21	STP134	93	20	SPL32	P2-U4	121	24
SPL21	STP136	98	24	SPL32	SPL46	121	18
SPL21	STP138	103	24	SPL33	P1-U5	127	24
SPL21	P8-G	105	24	SPL33	P1-U6	128	24
SPL22	P1-c3	94	24	SPL33	P1-V5	129	24
SPL22	P1-c4	95	24	SPL33	P1-V6	130	24
SPL22	P8-J	96	14	SPL33	P1-W6	131	24
SPL23	P1-c5	97	24	SPL34	P1-W1	132	24
SPL23	P1-c6	98	24	SPL34	P1-W2	133	24
SPL23	P8-K	98	24				

## 3-32. TPS CABLE ASSEMBLIES (cont)

3-32

## CABLE ASSEMBLY 13082730 WIRE LIST (cont)

FROM	TO	WIRE ID	WIRE SIZE	FROM	TO	WIRE ID	WIRE SIZE
SPL34	P1-W3	134	24	SPL45	SPL31	119	18
SPL34	P1-W4	135	24	SPL45	P10-A	173	18
SPL34	P1-W5	136	24	SPL46	SPL30	116	18
SPL35	P12-A	138	24	SPL46	SPL32	121	18
SPL35	P12-B	139	24	SPL46	P10-B	174	18
SPL35	P12-C	140	24	STP1	P1	1	24
SPL35	P12-D	141	24	STP1	SPL1	1	24
SPL36	P12-F	142	24	STP2	P3	1	24
SPL36	P12-G	143	24	STP2	SPL2	1	24
SPL36	P12-H	144	24	STP3	P1	2	24
SPL36	P12-J	145	24	STP3	SPL1	2	24
SPL37	P1-X1	146	24	STP4	P3	2	24
SPL37	P1-X2	147	24	STP4	SPL2	2	24
SPL37	P1-X3	148	24	STP5	P1	3	24
SPL38	P1-Y1	149	24	STP5	SPL1	3	24
SPL38	P1-Y2	150	24	STP6	P3	3	24
SPL38	P1-Y3	151	24	STP6	SPL2	3	24
SPL39	P13-A	153	24	STP7	P1	4	24
SPL39	P13-B	154	24	STP7	SPL1	4	24
SPL39	P13-C	155	24	STP8	P3	4	24
SPL39	P13-D	156	24	STP8	SPL2	4	24
SPL40	P13-F	157	24	STP9	P1	5	24
SPL40	P13-G	158	24	STP9	SPL1	5	24
SPL40	P13-H	159	24	STP10	P3	5	24
SPL40	P13-E	160	24	STP10	SPL2	5	24
SPL41	STP149	162	24	STP11	P1	6	24
SPL41	STP151	163	24	STP11	SPL1	6	24
SPL41	P1-b6	164	24	STP12	P3	6	24
SPL42	STP150	162	24	STP12	SPC2	6	24
SPL42	STP152	163	24	STP13	P1	7	24
SPL42	P14-E	165	24	STP13	SPL1	7	24
SPL43	STP153	166	24	STP14	P3	7	24
SPL43	STP155	167	24	STP14	SPL2	7	24
SPL43	P1-a4	168	24	STP15	P1	8	24
SPL44	STP154	166	24	STP15	SPL1	8	24
SPL44	STP156	167	24	STP16	P3	8	24
SPL44	P14-K	169	24	STP16	SPL2	8	24
SPL45	SPL29	114	18	STP17	P1	11	24
				STP17	SPL3	11	24
				STP18	P3	11	24
				STP18	SPL4	11	24
				STP19	P1	12	24
				STP19	SPL3	12	24
				STP20	P3	12	24
				STP20	SPL4	12	24

CABLE ASSEMBLY 13082730 WIRE LIST (cont)

FROM	TO	WIRE ID	WIRE SIZE	FROM	TO	WIRE ID	WIRE SIZE
STP21	P1	13	24	STP43	P1	26	24
STP21	SPL3	13	24	STP43	SPL5	26	24
STP22	P3	13	24	STP44	P3	26	24
STP22	SPL4	13	24	STP44	SPL6	26	24
STP23	P1	14	24	STP45	P1	27	24
STP23	SPL3	14	24	STP45	SPL5	27	24
STP24	P3	14	24	STP46	P3	27	24
STP24	SPL4	14	24	STP46	SPL6	27	24
STP25	P1	15	24	STP47	P1	28	24
STP25	SPL3	15	24	STP47	SPL5	28	24
STP26	P3	15	24	STP48	P3	28	24
STP26	SPL4	15	24	STP48	SPL6	28	24
STP27	P1	16	24	STP49	P1	31	24
STP27	SPL3	16	24	STP49	SPL7	31	24
STP28	P3	16	24	STP50	P3	31	24
STP28	SPL4	16	24	STP50	SPL8	31	24
STP29	P1	17	24	STP51	P1	32	24
STP29	SPL3	17	24	STP51	SPL7	32	24
STP30	P3	17	24	STP52	P3	32	24
STP30	SPL4	17	24	STP52	SPL8	32	24
STP31	P1	18	24	STP53	P1	33	24
STP31	SPL3	18	24	STP53	SPL7	33	24
STP32	P3	18	24	STP54	P3	33	24
STP32	SPL4	18	24	STP54	SPL8	33	24
STP33	P1	21	24	STP55	P1	34	24
STP33	SPL5	21	24	STP55	SPL7	34	24
STP34	P3	21	24	STP56	P3	34	24
STP34	SPL6	21	24	STP56	SPL8	34	24
STP35	P1	22	24	STP57	P1	35	24
STP35	SPL5	22	24	STP57	SPL7	35	24
STP36	P3	22	24	STP58	P3	35	24
STP36	SPL6	22	24	STP58	SPL8	35	24
STP37	P1	23	24	STP59	P1	36	24
STP37	SPL5	23	24	STP59	SPL7	36	24
STP38	P3	23	24	STP60	P3	36	24
STP38	SPL6	23	24	STP60	SPL8	36	24
STP39	P1	24	24	STP61	P1	37	24
STP39	SPL5	24	24	STP61	SPL7	37	24
STP40	P3	24	24	STP62	P3	37	24
STP40	SPL6	24	24	STP62	SPL8	37	24
STP41	P1	25	24	STP63	P1	38	24
STP41	SPL5	25	24	STP63	SPL7	38	24
STP42	P3	25	24	STP64	P3	38	24
STP42	SPL6	25	24				



## 3-32. TPS CABLE ASSEMBLIES (cont)

3-32

## CABLE ASSEMBLY 13082730 WIRE LIST (cont)

FROM	TO	WIRE ID	WIRE SIZE	FROM	TO	WIRE ID	WIRE SIZE
STP64	SPL8	38	24	STP85	SPL11	53	24
STP65	P1	41	24	STP86	P3	53	24
STP65	SPL9	41	24	STP86	SPL12	53	24
STP66	P3	41	24	STP87	P1	54	24
STP66	SPL10	41	24	STP87	SPL11	54	24
STP67	P1	42	24	STP88	P3	54	24
STP67	SPL9	42	24	STP88	SPL12	54	24
STP68	P3	42	24	STP89	P1	55	24
STP68	SPL10	42	24	STP89	STP11	55	24
STP69	P1	43	24	STP90	P3	55	24
STP69	SPL9	43	24	STP90	STP12	55	24
STP70	P3	43	24	STP91	P1	56	24
STP70	SPL10	43	24	STP91	STP11	56	24
STP71	P1	44	24	STP92	P3	56	24
STP71	SPL9	44	24	STP92	STP12	56	24
STP72	P3	44	24	STP93	P1	57	24
STP72	SPL10	44	24	STP93	STP11	57	24
STP73	P1	45	24	STP94	P3	57	24
STP73	SPL9	45	24	STP94	STP12	57	24
STP74	P3	45	24	STP95	P1	58	24
STP74	SPL10	45	24	STP95	STP11	58	24
STP75	P1	46	24	STP96	P3	58	24
STP75	SPL9	46	24	STP96	STP12	58	24
STP76	P3	46	24	STP97	P1	61	24
STP76	SPL10	46	24	STP97	SPL13	61	24
STP77	P1	47	24	STP98	P3	61	24
STP77	SPL9	47	24	STP98	SPL14	61	24
STP78	P3	47	24	STP99	P1	62	24
STP78	SPL10	47	24	STP99	SPL13	62	24
STP79	P1	48	24	STP100	P3	62	24
STP79	SPL9	48	24	STP100	SPL14	62	24
STP80	P3	48	24	STP101	P1	63	24
STP80	SPL10	48	24	STP101	SPL13	63	24
STP81	P1	51	24	STP102	P3	63	24
STP81	SPL11	51	24	STP102	SPL14	63	24
STP82	P3	51	24	STP103	P1	64	24
STP82	SPL12	51	24	STP103	SPL13	64	24
STP83	P1	52	24	STP104	P3	64	24
STP83	SPL11	52	24	STP104	SPL14	64	24
STP84	P3	52	24	STP105	P1	65	24
STP84	SPL12	52	24	STP105	SPL13	65	24
STP85	P1	53	24	STP106	P3	65	24

CABLE ASSEMBLY 13082730 WIRE LIST (cont)

FROM	TO	WIRE ID	WIRE SIZE	FROM	TO	WIRE ID	WIRE SIZE
STP106	SPL14	65	24	STP122	P1	80	24
STP107	P2	66	24	STP122	SPL17	80	24
STP107	SPL13	66	24	STP123	P1	81	24
STP108	P3	66	24	STP123	SPL17	81	24
STP108	SPL14	66	24	STP124	P1	82	24
STP109	P2	67	24	STP124	SPL17	82	24
STP109	SPL13	67	24	STP125	P1	84	24
STP110	P3	67	24	STP125	SPL19	84	24
STP110	SPL14	67	24	STP126	P1	85	24
STP111	P2	68	24	STP126	SPL19	85	24
STP111	SPL13	68	24	STP127	P1	86	24
STP112	P3	68	24	STP127	SPL19	86	24
STP112	SPL14	68	24	STP128	P1	86	24
STP113	P2	71	24	STP128	SPL19	87	24
STP113	SPL15	71	24	STP129	P1	88	24
STP114	P3	71	24	STP129	SPL19	88	24
STP114	SPL16	71	24	STP130	P1	89	24
STP115	P2	72	24	STP130	SPL19	89	24
STP115	SPL15	72	24	STP131	P1	90	24
STP116	P3	72	24	STP131	SPL19	90	24
STP116	SPL16	72	24	STP132	P2	91	24
STP117	P1	75	24	STP132	SPL15	91	24
STP117	SPL17	75	24	STP133	P1	93	24
STP118	P2	76	24	STP133	SPL20	93	24
STP118	SPL15	76	24	STP134	P8	93	24
STP119	P1	77	24	STP134	SPL21	93	24
STP119	SPL17	77	24	STP135	P1	98	24
STP120	P2	78	24	STP135	SPL20	98	24
STP120	SPL15	78	24	STP136	P8	98	24
STP121	P1	79	24	STP136	SPL21	98	24
STP121	SPL17	79	24	STP137	P1	103	24
				STP137	SPL20	103	24
				STP138	P8	103	24
				STP138	SPL21	103	24
				STP139	P1	110	24
				STP139	SPL28	110	18
				STP140	P1	111	24
				STP140	SPL28	111	20
				STP141	P1	116	24
				STP141	SPL28	116	18
				STP142	P2	121	24

## 3-32. TPS CABLE ASSEMBLIES (cont)

3-32

## CABLE ASSEMBLY 13082730 WIRE LIST (cont)

FROM	TO	WIRE ID	WIRE SIZE
STP142	SPL15	121	18
STP143	P1	122	24
STP143	SPL28	122	20
STP144	P2	123	24
STP144	SPL15	123	20
STP145	P1	125	24
STP145	SPL28	125	24
STP146	P1	126	24
STP146	SPL28	126	24
STP147	P1	145	24
STP147	SPL28	145	24
STP148	P1	160	24
STP148	SPL28	160	24
STP149	P1	162	24
STP149	SPL41	162	24
STP150	P14	163	24
STP150	SPL42	162	24
STP151	P1	163	24
STP151	SPL41	163	24
STP152	P14	163	24
STP152	SPL42	163	24
STP153	P1	166	24
STP153	SPL43	166	24
STP154	P14	166	24
STP154	SPL44	166	24
STP155	P1	167	24
STP155	SPL43	167	24
STP156	P14	167	24
STP156	SPL44	167	24



CABLE ASSEMBLY 13083093 WIRE LIST

FROM	TO	WIRE SIZE
P1-A4	P2	COAX
P1-A4 SHLD	SPLICE	COAX
P1-B4	P3	COAX
P1-B4 SHLD	SPLICE	COAX
P1-C4	P4	COAX
P1-C4 SHLD	SPLICE	COAX
P1-D4	P5	COAX
P1-D4 SHLD	SPLICE	COAX
P1-E4	P6	COAX
P1-E4 SHLD	SPLICE	COAX
P1-S5	P1-T1	24
■ P1-T1	P1-S5	24
P1-U2	P1-V2	24
P1-V2	P1-U2	24
P1-V2	SPLICE	24
■ P2	P1-A4	COAX
P2	SHLD	COAX
P3	P1-B4	COAX
P3	SHLD	COAX
P4	P1-C4	COAX
P4	SHLD	COAX
P5	P1-D4	COAX
P5	SHLD	COAX
P6	P1-E4	COAX
P6	SHLD	COAX
SHLD	P2	COAX
SHLD	P3	COAX
SHLD	P4	COAX
SHLD	P5	COAX
SHLD	P6	COAX
SPLICE	P1-V2	24
■ SPLICE	P1-A4 SHLD	COAX
SPLICE	P1-B4 SHLD	COAX
SPLICE	P1-C4 SHLD	COAX
SPLICE	P1-D4 SHLD	COAX
SPLICE	P1-E4 SHLD	COAX

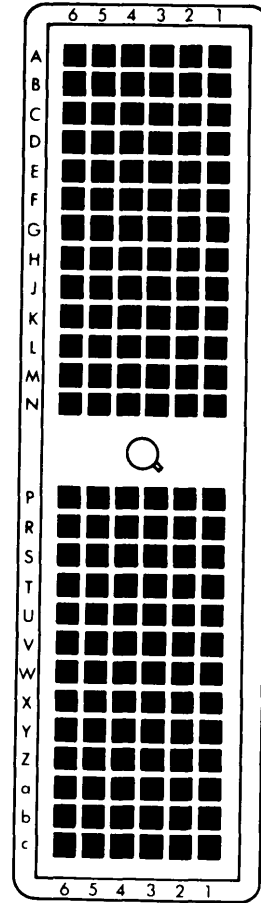

EL9LQ-1000-82A

P1 - DL1-156P





CABLE ASSEMBLY 133083226 WIRE LIST

FROM	TO	WIRE SIZE	FROM	TO	WIRE SIZE
P1-A	P2-A	24	P2-H	P1-H	24
P1-B	P2-B	24	P2-J	P1-J	24
P1-C	P2-C	24	P2-K	P1-K	24
P1-D	P2-D	24	P2-L	P1-L	24
P1-E	P2-E	24	P2-M	P1-M	24
P1-F	P2-F	24	P2-N	P1-N	24
P1-G	P2-G	24	P2-P	P1-P	24
P1-H	P2-H	24	P2-R	P1-R	24
P1-J	P2-J	24	P2-S	P1-S	24
P1-K	P2-K	24	P2-T	P1-T	24
P1-L	P2-L	24	P2-U	P1-U	24
P1-M	P2-M	24	P2-V	P1-V	24
P1-N	P2-N	24	P2-W	P1-W	COAX
P1-P	P2-P	24	P2-X	STP3	24
P1-R	P2-R	24	P2-Y	P1-Y	24
P1-S	P2-S	24	P2-Z	SPL2	24
P1-T	P2-T	24	P2-a	SPL4	24
P1-U	P2-U	24	P2-b	P1-b	24
P1-V	P2-V	24	P2-c	P1-c	24
P1-W	P2-W	COAX	P2-d	P1-d	24
P1-W	P3	COAX	P2-e	P1-e	24
P1-X	STP1	24	P2-g	P1-g	24
P1-X	STP2	24	P2-h	P1-h	24
P1-Y	P2-Y	24	P2-m	P1-m	COAX
P1-Z	SPL1	24	P3	P1-W	COAX
P1-a	SPL3	24	SPL1	P1-Z	24
P1-b	P2-b	24	SPL1	SPL2	12
P1-c	P2-c	24	SPL2	P2-Z	24
P1-d	P2-d	24	SPL2	SPL1	12
P1-e	P2-e	24	SPL3	P1-a	24
P1-g	P2-g	24	SPL3	SPL4	12
P1-h	P2-h	24	SPL4	P2-a	24
P1-m	P2-m	COAX	SPL4	SPL3	12
P2-A	P1-A	24	STP1	P1-X	24
P2-B	P1-B	24	STP2	P1-X	24
P2-C	P1-C	24	STP3	P2-X	24
P2-D	P1-D	24			
P2-E	P1-E	24			
P2-F	P1-F	24			
P2-G	P1-G	24			

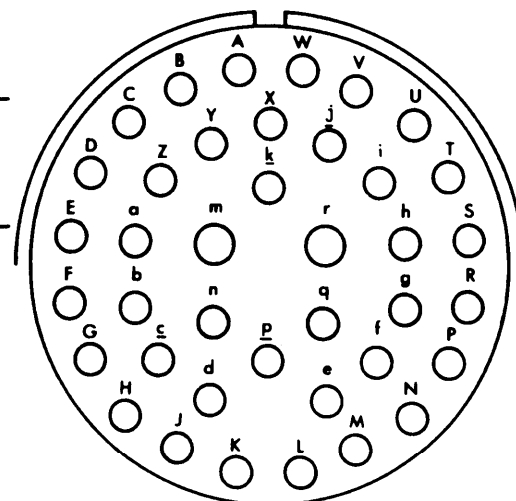

EL9LQ-1000-42A

P1-MS27467T21F39S

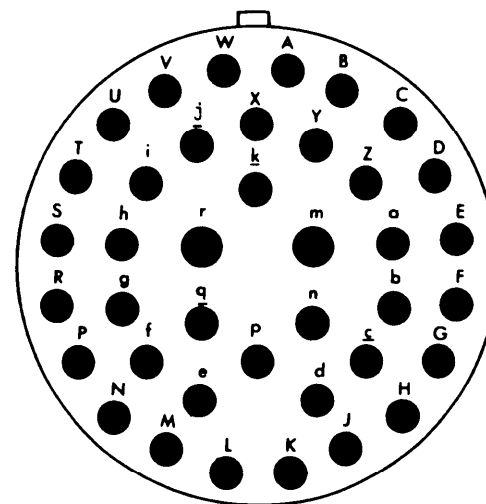

EL9LQ-1000-42A

P2-MS27468P21F39P



3-32. TPS CABLE ASSEMBLIES (cont)

3-32

CABLE ASSEMBLY 13083689 WIRE LIST (cont)

FROM	TO	WIRE ID	WIRE SIZE	FROM	TO	WIRE ID	WIRE SIZE
P4-FF	P1-X2	33	24	P5-41	P5-43	147	24
P4-GG	P4-HH	131	24	P5-42	P5-40	146	24
P4-HH	P4-GG	131	24	P5-43	P5-41	147	24
P5-1	P2-G2	67	24	P5-44	P5-7	135	24
P5-2	P5-37	132	24	P5-45	P5-17	138	24
P5-3	P2-H5	76	24	P5-46	P5-47	148	24
P5-4	P5-23	133	24	P5-47	P5-46	148	24
P5-5	P2-H4	75	24	P5-50	P2-G3	68	24
P5-6	P5-21	134	24	P5-51	P2-K6	89	24
P5-7	P5-44	135	24	P5-52	P5-53	149	24
P5-8	P2-Z2	109	24	P5-53	P5-52	149	24
P5-9	P2-Z3	110	24	P5-54	P5-77	150	24
P5-10	P5-19	136	24	P5-55	P5-56	151	24
P5-12	P2-H3	74	24	P5-56	P5-55	151	24
P5-13	P5-14	137	24	P5-57	P5-35	145	24
P5-14	P5-13	137	24	P5-58	P5-59	152	24
P5-15	P2-Z1	108	24	P5-59	P5-58	152	24
P5-17	P5-45	138	24	P5-60	P2-J3	80	24
P5-18	P5-38	139	24	P5-61	P2-J5	82	24
P5-19	P5-10	136	24	P5-63	P5-64	153	24
P5-21	P5-6	134	24	P5-64	P5-63	153	24
P5-22	P5-26	140	24	P5-66	P5-67	154	24
P5-23	P5-4	133	24	P5-67	P5-66	154	24
P5-24	P5-25	141	24	P5-68	P2-J4	81	24
P5-25	P5-24	141	24	P5-69	P2-J6	83	24
P5-26	P5-22	140	24	P5-70	P2-H1	72	24
P5-27	P2-G6	71	24	P5-71	P2-H2	73	24
P5-28	P5-29	142	24	P5-74	P5-78	155	24
P5-29	P5-28	142	24	P5-75	P5-76	156	24
P5-30	P5-31	143	24	P5-76	P5-75	156	24
P5-31	P5-30	143	24	P5-77	P5-54	150	24
P5-32	P5-33	144	24	P5-78	P5-74	155	24
P5-33	P5-32	144	24				
P5-34	P2-a2	112	24				
P5-35	P5-57	145	24				
P5-36	P2-H6	77	24				
P5-37	P5-2	132	24				
P5-38	P5-18	139	24				
P5-39	P2-G4	69	24				
P5-40	P5-42	146	24				

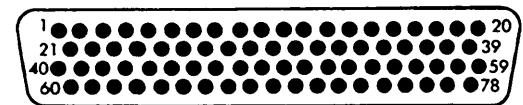

EL9LQ-1000-69

P5-M24308/4-15F



CABLE ASSEMBLY 13083689 WIRE LIST (cont)

FROM	TO	WIRE ID	WIRE SIZE	FROM	TO	WIRE ID	WIRE SIZE
P6-20	P2-E4	62	24	P7-26	P2-L4	93	24
P6-21	P2-D4	60	24	P7-27	P7-28	166	24
P6-22	P2-J1	78	24	P7-28	P7-27	166	24
P6-23	P2-F4	64	24	P7-29	P2-L5	94	24
P6-24	P6-25	157	24	P7-30	P7-48	167	24
P6-25	P6-24	157	24	P7-31	P7-42	168	24
P6-26	P2-C4	58	24	P7-32	P2-K2	85	24
P6-27	P2-B4	56	24	P7-34	P7-35	169	24
P6-28	P2-E6	63	24	P7-35	P7-34	169	24
P6-29	P1-Y3	39	24	P7-37	P2-L3	92	24
P6-30	P1-Y4	40	24	P7-38	P2-L6	95	24
P6-31	P1-Y5	41	24	P7-39	P2-G5	70	24
P6-32	P6-33	158	24	P7-40	P7-4	161	24
P6-33	P6-32	158	24	P7-41	P2-K3	86	24
P6-34	P6-35	159	24	P7-42	P7-31	168	24
P6-35	P6-34	159	24	P7-43	P7-47	170	24
P6-36	P2-A4	54	24	P7-44	P2-M3	98	24
P6-37	P2-F6	65	24	P7-45	P2-M4	99	24
P7-1	P2-M1	96	24	P7-46	P2-G1	66	24
P7-2	P2-M2	97	24	P7-47	P7-43	170	24
P7-3	P7-6	160	24	P7-48	P7-30	167	24
P7-4	P7-40	161	24	P7-49	P7-24	165	24
P7-5	P2-N3	104	24	P7-50	P2-M5	100	24
P7-6	P7-3	160	24				
P7-7	P2-N1	102	24				
P7-8	P2-K5	88	24				
P7-9	P7-11	162	24				
P7-10	P2-N4	105	24				
P7-11	P7-9	162	24				
P7-12	P2-K4	87	24				
P7-13	P2-L2	91	24				
P7-14	P7-15	163	24				
P7-15	P7-14	163	24				
P7-16	P2-K1	84	24				
P7-17	P2-M6	101	24				
P7-18	P2-N2	103	24				
P7-19	P2-N5	106	24				
P7-20	P2-a1	111	24				
P7-21	P2-L1	90	24				
P7-22	P7-23	164	24				
P7-23	P7-22	164	24				
P7-24	P7-49	165	24				
P7-25	P2-N6	107	24				

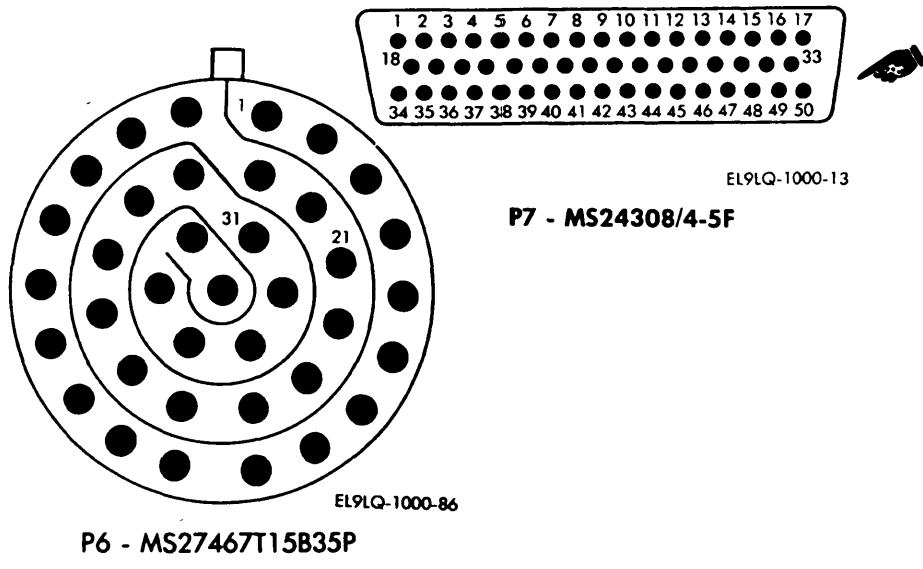

CABLE ASSEMBLY 13083689-39 WIRE LIST

FROM	TO	WIRE ID	WIRE SIZE	FROM	TO	WIRE ID	WIRE SIZE
P1-A1	P1-N1	23	24	P1-V3	P5-8	34	24
P1-A3	P12-1	1	24	P1-V4	P5-9	35	24
P1-A5	P7-48	2	24	P1-V5	P5-21	36	24
P1-B1	P7-44	3	24	P1-V6	P5-70	37	24
P1-B3	P7-45	4	24	P1-W1	P5-65	38	24
P1-C3	P3-m	7	24	P1-W2	P5-41	39	24
P1-C5	P9-15	8	24	P1-W3	P5-83	40	24
P1-D1	P9-10	9	24	P1-W4	P5-33	41	24
P1-D3	P9-8	10	24	P1-W5	P5-5	42	24
P1-D5	P11-4	11	24	P1-W6	P5-4	43	24
P1-E1	P3-v	12	24	P1-X1	P5-79	44	24
P1-E2	P1-R1	13	24	P1-X2	P5-72	45	24
P1-E3	P12-74	14	24	P1-X3	P5-56	46	24
P1-F2	P1-L4	15	24	P1-X4	P5-63	47	24
P1-H6	P1-L3	16	24	P1-X5	P5-61	48	24
P1-J1	P1-Y3	17	24	P1-X6	P5-27	49	24
P1-J1	P7-6	18	24	P1-Y1	P5-100	50	24
P1-J2	P1-R5	19	24	P1-Y2	P4-78	51	24
P1-J2	P7-11	20	24	P1-Y3	P1-J1	17	24
P1-K6	P1-S5	21	24	P1-Y4	P5-99	52	24
P1-L3	P1-H6	16	24	P1-Y5	P5-37	53	24
P1-L4	P1-F2	15	24	P1-Y6	P5-75	54	24
P1-M1	P1-N3	5	24	P1-Z1	P4-1	55	24
P1-M5	P1-R3	25	24	P1-Z2	P4-71	56	24
P1-M5	P6-6	22	24	P1-Z3	P4-73	57	24
P1-N1	P1-A1	23	24	P1-Z4	P4-13	58	24
P1-N1	P3-a	24	24	P1-Z5	P4-55	59	24
P1-N3	P1-M1	5	24	P1-Z6	P4-77	60	24
P1-N3	P3-E	6	24	P1-a1	P13-6	61	24
P1-R1	P1-E2	13	24	P1-a2	P5-44	62	24
P1-R3	P1-M5	25	24	P1-a3	P4-93	63	24
P1-R5	P1-J2	19	24	P1-a4	P4-27	64	24
P1-S5	P1-K6	21	24	P1-a5	P4-24	65	24
P1-U1	P5-55	26	24	P1-a6	P6-26	66	24
P1-U2	P8-31	27	24	P2-A4	P8-29	67	24
P1-U4	P6-9	29	24	P2-A6	P5-59	68	24
P1-U5	P5-49	30	24	P2-B4	P10-15	69	24
P1-U6	P16-2	31	24	P2-B6	P6-24	70	24
P1-V1	P5-17	32	24	P2-C4	P10-22	71	24
P1-V2	P5-14	33	24	P2-C5	P3-Y	72	24

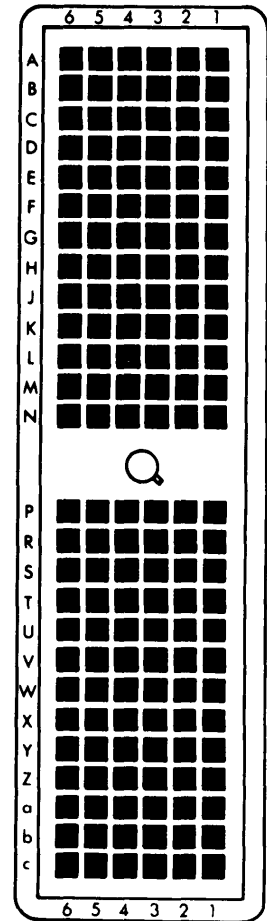

EL9LQ-1000-82A

P1 and P2 - DL1-156P

## CABLE ASSEMBLY 13083689-39 WIRE LIST (cont)

FROM	TO	WIRE ID	WIRE SIZE	FROM	TO	WIRE ID	WIRE SIZE
P2-C6	P7-50	73	24	P2-L2	P15-74	128	24
P2-D1	P3-z	74	24	P2-L3	P15-68	130	24
P2-D3	P3-S	75	24	P2-L4	P15-73	131	24
P2-D4	P10-21	76	24	P2-L5	P15-38	132	24
P2-D5	P3-e	77	24	P2-L6	P15-19	133	24
P2-D6	P7-46	78	24	P2-M1	P16-8	134	24
P2-E1	P3-A	79	24	P2-M2	P16-9	135	24
P2-E3	P3-C	80	24	P2-M3	P16-6	136	24
P2-E4	P10-20	81	24	P2-M4	P16-7	137	24
P2-E5	P3-HH	82	24	P2-M5	P16-3	138	24
P2-E6	P8-13	83	24	P2-M6	P16-1	139	24
P2-F1	P3-X	84	24	P2-N1	P10-14	140	24
P2-F2	P3-AA	85	24	P2-N2	P10-13	141	24
P2-F3	P4-4	92	24	P2-N3	P10-12	142	24
P2-F4	P10-19	101	24	P2-N4	P10-11	143	24
P2-F6	P8-14	102	24	P2-N5	P10-9	144	24
P2-G1	P8-43	103	24	P2-N6	P10-10	145	24
P2-G2	P8-20	104	24	P2-S5	P3-r	146	24
P2-G3	P8-32	105	24	P2-T1	P3-R	147	24
P2-G4	P7-49	106	24	P2-T3	P8-25	148	24
P2-G5	P7-47	107	24	P2-T5	P8-16	149	24
P2-G6	P2-V1	108	24	P2-U1	P8-17	150	24
P2-H1	P7-36	110	24	P2-U2	P5-13	151	24
P2-H2	P7-37	111	24	P2-U3	P8-10	158	24
P2-H3	P8-27	112	24	P2-U4	P6-37	159	24
P2-H4	P8-21	113	24	P2-U5	P8-11	160	24
P2-H5	P8-50	114	24	P2-U6	P8-19	161	24
P2-H6	P8-46	115	24	P2-V1	P2-V2	109	24
P2-J1	P13-9	116	24	P2-V1	P2-G6	108	24
P2-J2	P13-7	117	24	P2-V2	P2-V1	109	24
P2-J3	P13-3	118	24	P3-A	P2-E1	79	24
P2-J4	P13-5	119	24	P3-C	P2-E3	80	24
P2-J5	P12-39	120	24	P3-D	P3-W	89	24
P2-J6	P12-20	121	24	P3-D	P3-f	88	24
P2-K1	P15-40	122	24	P3-E	P1-N3	6	24
P2-K2	P15-60	123	24	P3-F	P3-LL	170	24
P2-K4	P14-58	124	24	P3-F	P3-b	169	24
P2-K5	P14-77	125	24	P3-G	P3-h	174	24
P2-K6	P13-8	126	24	P3-H	P3-c	165	24
P2-L1	P15-69	127	24	P3-H	P3-M	91	24

CABLE ASSEMBLY 13083689-39 WIRE LIST (cont)

FROM	TO	WIRE ID	WIRE SIZE
P3-J	P3-K	172	24
P3-K	P3-J	172	24
P3-L	P3-s	176	24
P3-M	P3-H	91	24
P3-M	P3-W	90	24
P3-R	P2-T1	147	24
P3-S	P2-D3	75	24
P3-T	P3-U	173	24
P3-U	P3-T	173	24
P3-W	P3-M	90	24
P3-W	P3-D	89	24
P3-X	P2-F1	84	24
P3-Y	P2-C5	72	24
P3-a	P1-N1	24	24
P3-b	P3-F	169	24
P3-b	P3-w	168	24
P3-c	P3-GG	166	24
P3-c	P3-H	165	24
P3-d	P3-f	87	24
P3-d	P3-AA	86	24
P3-e	P2-D5	77	24
P3-f	P3-D	88	24
P3-f	P3-d	87	24
P3-g	P3-k	175	24
P3-h	P3-G	174	24
P3-k	P3-g	175	24
P3-m	P1-C3	7	24
P3-r	P2-S5	146	24
P3-s	P3-L	176	24
P3-v	P1-E1	12	24
P3-w	P3-b	168	24
P3-w	P3-GG	167	24
P3-y	P3-DD	177	24
P3-z	P2-D1	74	24
P3-AA	P3-d	86	24
P3-AA	P2-F2	85	24
P3-DD	P3-y	177	24
P3-EE	P3-JJ	178	24
P3-FF	P3-LL	171	24
P3-GG	P3-c	166	24

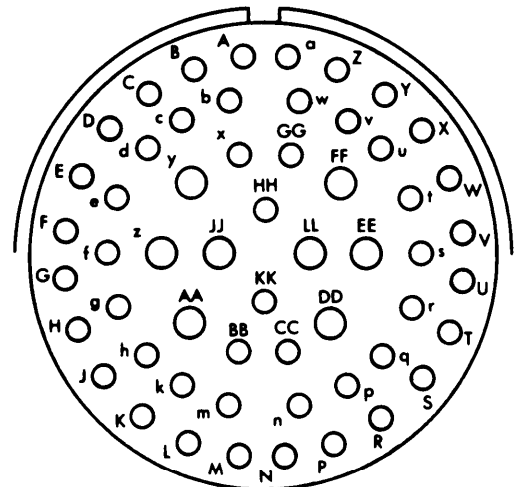

EL9LQ-1000-79

**P3 - MS27467T25B4S**



CABLE ASSEMBLY 13083689-39 WIRE LIST (cont)

FROM	TO	WIRE ID	WIRE SIZE	FROM	TO	WIRE ID	WIRE SIZE
P3-GG	P3-w	167	24	P4-73	P1-Z3	57	24
P3-HH	P2-E5	82	24	P4-74	P4-59	186	24
P3-JJ	P3-EE	178	24	P4-77	P1-Z6	60	24
P3-LL	P3-F	170	24	P4-78	P1-Y2	51	24
P3-LL	P3-FF	171	24	P4-80	P4-57	98	24
P4-1	P1-Z1	55	24	P4-80	P4-72	97	24
P4-2	P4-3	179	24	P4-93	P1-a3	63	24
P4-3	P4-2	179	24	P4-94	P4-21	181	24
P4-4	P4-20	93	24	P5-1	P5-2	187	24
P4-4	P2-F3	92	24	P5-2	P5-1	187	24
P4-13	P1-Z4	58	24	P5-3	P5-73	198	24
P4-14	P4-56	180	24	P5-3	P5-6	197	24
P4-18	P4-26	183	24	P5-4	P1-W6	43	24
P4-19	P4-22	95	24	P5-5	P1-W5	42	24
P4-19	P4-20	94	24	P5-6	P5-3	197	24
P4-20	P4-19	94	24	P5-6	P5-60	196	24
P4-20	P4-4	93	24	P5-7	P5-12	200	24
P4-21	P4-94	181	24	P5-7	P5-73	199	24
P4-22	P4-72	96	24	P5-8	P1-V3	34	24
P4-22	P4-19	95	24	P5-9	P1-V4	35	24
P4-23	P4-25	182	24	P5-10	P5-23	188	24
P4-24	P1-a5	65	24				
P4-25	P4-23	182	24				
P4-26	P4-18	183	24				
P4-27	P1-a4	64	24				
P4-42	P4-43	184	24				
P4-43	P4-42	184	24				
P4-50	P4-60	185	24				
P4-55	P1-Z5	59	24				
P4-56	P4-14	180	24				
P4-57	P4-58	99	24				
P4-57	P4-80	98	24				
P4-58	P4-60	100	24				
P4-58	P4-57	99	24				
P4-59	P4-74	186	24				
P4-60	P4-50	185	24				
P4-60	P4-58	100	24				
P4-71	P1-Z2	56	24				
P4-72	P4-80	97	24				
P4-72	P4-22	96	24				

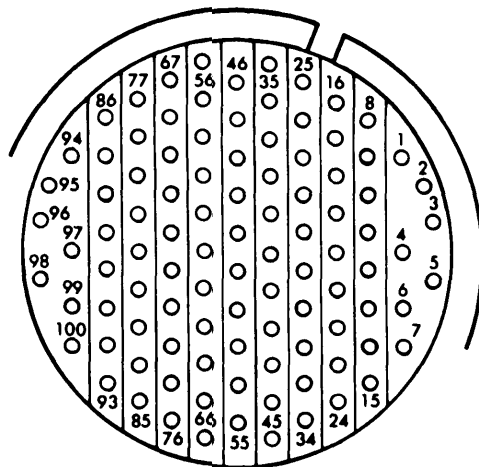

EL9LQ-1000-3A

**P4 - MS27467T23B35SA**

CABLE ASSEMBLY 13083689-39 WIRE LIST (cont)

FROM	TO	WIRE ID	WIRE SIZE	FROM	TO	WIRE ID	WIRE SIZE
P5-11	P5-74	211	24	P5-53	P5-34	204	24
P5-12	P5-22	201	24	P5-53	P1-U1	26	24
P5-12	P5-7	200	24	P5-56	P1-X3	46	24
P5-13	P5-50	152	24	P5-59	P2-A6	68	24
P5-13	P2-U2	151	24	P5-60	P5-6	196	24
P5-14	P1-V2	33	24	P5-60	P5-43	195	24
P5-15	P5-16	189	24	P5-61	P1-X5	48	24
P5-16	P5-15	189	24	P5-62	P5-89	208	24
P5-17	P1-V1	32	24	P5-63	P1-X4	47	24
P5-18	P5-19	190	24	P5-64	P5-67	209	24
P5-19	P5-18	190	24	P5-65	P1-W1	38	24
P5-20	P5-71	191	24	P5-67	P5-64	209	24
P5-21	P1-V5	36	24	P5-68	P5-69	210	24
P5-22	P5-47	202	24	P5-69	P5-68	210	24
P5-22	P5-12	201	24	P5-70	P1-V6	37	24
P5-23	P5-10	188	24	P5-71	P5-20	191	24
P5-25	P5-26	192	24	P5-72	P1-X2	45	24
P5-26	P5-25	192	24	P5-73	P5-7	199	24
P5-27	P1-X6	49	24				
P5-28	P5-82	193	24				
P5-28	P5-90	157	24				
P5-29	P5-38	205	24				
P5-30	P5-78	154	24				
P5-30	P5-50	153	24				
P5-31	P5-32	203	24				
P5-32	P5-31	203	24				
P5-33	P1-W4	41	24				
P5-34	P5-53	204	24				
P5-37	P1-Y5	53	24				
P5-38	P5-29	205	24				
P5-40	P5-81	206	24				
P5-41	P1-W2	39	24				
P5-43	P5-60	195	24				
P5-43	P5-82	194	24				
P5-44	P1-a2	62	24				
P5-45	P5-46	207	24				
P5-46	P5-45	207	24				
P5-47	P5-22	202	24				
P5-49	P1-U5	30	24				
P5-50	P5-30	153	24				
P5-50	P5-13	152	24				

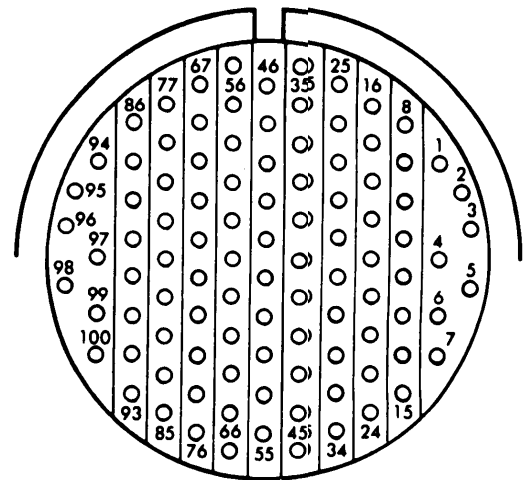

EL9LQ-1000-51

**F5 - MS27467T23B35S**

CABLE ASSEMBLY 13083689-39 WIRE LIST (cont)

FROM	TO	WIRE ID	WIRE SIZE
P5-73	P5-3	198	24
P5-74	P5-11	211	24
P5-75	P1-Y6	54	24
P5-76	P5-77	212	24
P5-77	P5-76	212	24
P5-78	P5-80	155	24
P5-78	P5-30	154	24
P5-79	P1-X1	44	24
P5-80	P5-90	156	24
P5-80	P5-78	155	24
P5-81	P5-40	206	24
P5-82	P5-43	194	24
P5-82	P5-28	193	24
P5-83	P1-W3	40	24
P5-89	P5-62	208	24
P5-90	P5-28	157	24
P5-90	P5-80	156	24
P5-99	P1-Y4	52	24
P5-100	P1-Y1	50	24
P6-6	P1-M5	22	24
P6-7	P6-36	213	24
P6-9	P1-U4	29	24
P6-24	P2-B6	70	24
P6-26	P1-a6	66	24
P6-36	P6-7	213	24
P6-37	P2-U4	159	24
P7-4	P7-21	214	24
P7-6	P1-J1	18	24
P7-7	P7-24	215	24
P7-8	P7-25	216	24
P7-10	P7-32	224	24
P7-11	P1-J2	20	24
P7-12	P7-13	217	24
P7-13	P7-12	217	24
P7-14	P7-30	218	24
P7-15	P7-31	219	24
P7-15	P7-23	221	24
P7-16	P7-30	223	24
P7-17	P7-33	220	24
P7-21	P7-4	214	24

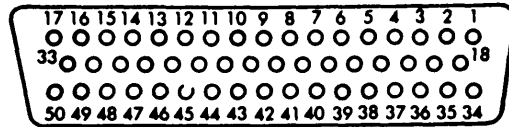

EL9LQ-1000-13

**P6-M24308/2-5 F**

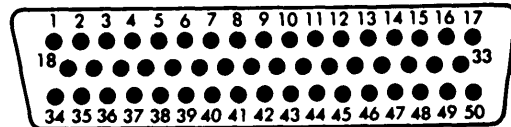

EL9LQ-1000-13

**P7 and P8-M24308/4-5 F**

## 3-32. TPS CABLE ASSEMBLIES (cont)

3-32

## CABLE ASSEMBLY 13083689-39 WIRE LIST (cont)

FROM	TO	WIRE ID	WIRE SIZE	FROM	TO	WIRE ID	WIRE SIZE
P7-23	P7-15	221	24	P8-27	P2-H3	112	24
P7-24	P7-7	215	24	P8-28	P8-19	162	24
P7-25	P7-8	216	24	P8-28	P8-47	163	24
P7-27	P7-28	222	24	P8-29	P2-A4	67	24
P7-28	P7-27	222	24	P8-30	P8-33	231	24
P7-30	P7-16	223	24	P8-30	P8-24	229	24
P7-30	P7-14	218	24	P8-31	P1-U2	27	24
P7-31	P7-15	219	24	P8-32	P2-G3	105	24
P7-32	P7-10	224	24	P8-33	P8-30	231	24
P7-33	P7-17	220	24	P8-34	P8-23	232	24
P7-36	P2-H1	110	24	P8-41	P8-8	233	24
P7-37	P2-H2	111	24	P8-43	P2-G1	103	24
P7-44	P1-B1	3	24	P8-44	P8-22	228	24
P7-45	P1-B3	4	24	P8-46	P2-H6	115	24
P7-46	P2-D6	78	24	P8-47	P8-28	163	24
P7-47	P2-G5	107	24	P8-47	P8-49	164	24
P7-48	P1-A5	2	24	P8-49	P11-1	230	24
P7-49	P2-G4	106	24	P8-49	P8-47	164	24
P7-50	P2-C6	73	24	P8-50	P2-H5	114	24
P8-1	P8-18	225	24				
P8-2	P8-3	226	24				
P8-3	P8-2	226	24				
P8-4	P8-5	227	24				
P8-5	P8-4	227	24				
P8-8	P8-41	233	24				
P8-10	P2-U3	158	24				
P8-11	P2-U5	160	24				
P8-13	P2-E6	83	24				
P8-14	P2-F6	102	24				
P8-16	P2-T5	149	24				
P8-17	P2-U1	150	24				
P8-18	P8-1	225	24				
P8-19	P8-28	162	24				
P8-19	P2-U6	161	24				
P8-20	P2-G2	104	24				
P8-21	P2-H4	113	24				
P8-22	P8-44	228	24				
P8-23	P8-34	232	24				
P8-24	P8-30	229	24				
P8-25	P2-T3	148	24				

CABLE ASSEMBLY 13083689-39 WIRE LIST (cont)

FROM	TO	WIRE ID	WIRE SIZE
P9-1	P9-9	234	24
P9-3	P9-12	237	24
P9-3	P9-6	236	24
P9-4	P9-5	235	24
P9-5	P9-4	235	24
P9-6	P9-3	236	24
P9-8	P1-D3	10	24
P9-9	P9-1	234	24
P9-10	P1-D1	9	24
P9-12	P9-3	237	24
P9-15	P1-C5	8	24
P10-9	P2-N5	144	24
P10-10	P2-N6	145	24
P10-11	P2-N4	143	24
P10-12	P2-N3	142	24
P10-13	P2-N2	141	24
P10-14	P2-N1	140	24
P10-15	P2-B4	69	24
P10-16	P10-17	238	24
P10-17	P10-18	239	24
P10-17	P10-16	238	24
P10-18	P10-17	239	24
P10-19	P2-F4	101	24
P10-20	P2-E4	81	24
P10-21	P2-D4	76	24
P10-22	P2-C4	71	24
P11-1	P8-49	230	24
P11-2	P11-3	240	24
P11-3	P11-2	240	24
P11-4	P1-D5	11	24

FROM	TO	WIRE ID	WIRE SIZE
------	----	---------	-----------

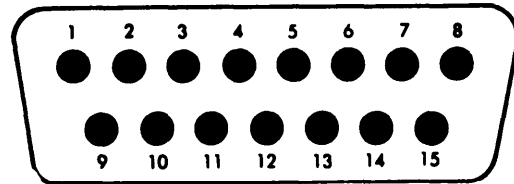

EL9LQ-1000-5

P9-M24308/4-2 F

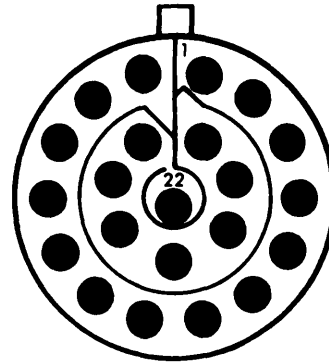

EL9LQ-1000-9

P10 - MS27468T13B35P

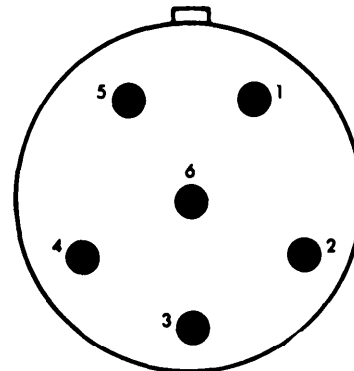

EL9LQ-1000-91

P11 - MS27467T9B35P

3-32. TPS CABLE ASSEMBLIES (cont)

3-32

CABLE ASSEMBLY 13083689-39 WIRE LIST (cont)

FROM	TO	WIRE ID	WIRE SIZE	FROM	TO	WIRE ID	WIRE SIZE
P12-1	P1-A3	1	24	P14-31	P14-11	249	24
P12-13	P12-32	241	24	P14-32	P14-26	257	24
P12-20	P2-J6	121	24	P14-33	P14-14	260	24
P12-32	P12-13	241	24	P14-34	P14-35	261	24
P12-39	P2-J5	120	24	P14-35	P14-34	261	24
P12-42	P12-62	242	24	P14-36	P14-16	252	24
P12-47	P12-67	243	24	P14-37	P14-18	262	24
P12-49	P12-69	244	24	P14-38	P14-27	258	24
P12-62	P12-42	242	24	P14-39	P14-19	254	24
P12-67	P12-47	243	24	P14-40	P14-60	263	24
P12-69	P12-49	244	24	P14-41	P14-61	264	24
P12-74	P1-E3	14	24	P14-42	P14-20	255	24
P13-3	P2-J3	118	24	P14-43	P14-63	268	24
P13-5	P2-J4	119	24	P14-44	P14-62	267	24
P13-6	P1-a1	61	24	P14-45	P14-64	269	24
P13-7	P2-J2	117	24				
P13-8	P2-K6	126	24				
P13-9	P2-J1	116	24				
P14-1	P14-21	245	24				
P14-3	P14-23	246	24				
P14-4	P14-5	247	24				
P14-5	P14-4	247	24				
P14-6	P14-25	256	24				
P14-8	P14-28	248	24				
P14-10	P14-15	251	24				
P14-11	P14-31	249	24				
P14-12	P14-13	250	24				
P14-13	P14-12	250	24				
P14-14	P14-33	260	24				
P14-15	P14-10	251	24				
P14-16	P14-36	252	24				
P14-17	P14-47	253	24				
P14-18	P14-37	262	24				
P14-19	P14-39	254	24				
P14-20	P14-42	255	24				
P14-21	P14-1	245	24				
P14-23	P14-3	246	24				
P14-24	P14-30	259	24				
P14-25	P14-6	256	24				
P14-26	P14-32	257	24				
P14-27	P14-38	258	24				
P14-28	P14-8	248	24				
P14-30	P14-24	259	24				

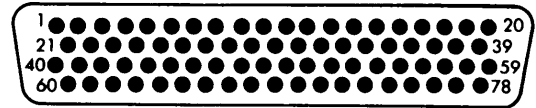

EL9LQ-1000-69

**P12, P14 and P15-M24308/4-15 F**

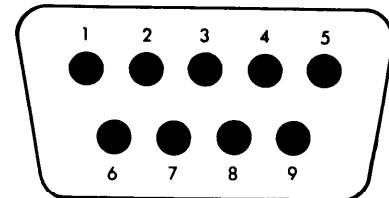

EL9LQ-1000-10

**P13 and P16-M24308/4-1 F**

## CABLE ASSEMBLY 13083689-39 WIRE LIST (cont)

FROM	TO	WIRE ID	WIRE SIZE	FROM	TO	WIRE ID	WIRE SIZE
P14-47	P14-17	253	24	P15-25	P15-5	274	24
P14-57	P14-76	265	24	P15-26	P15-6	275	24
P14-58	P2-K4	124	24	P15-27	P15-7	276	24
P14-59	P14-78	266	24	P15-28	P15-8	277	24
P14-60	P14-40	263	24	P15-29	P15-9	278	24
P14-61	P14-41	264	24	P15-31	P15-11	279	24
P14-62	P14-44	267	24	P15-35	P15-15	281	24
P14-63	P14-43	268	24	P15-36	P15-17	282	24
P14-64	P14-45	269	24	P15-38	P2-L5	132	24
P14-76	P14-57	265	24	P15-39	P15-20	283	24
P14-77	P2-K5	125	24	P15-40	P2-K1	122	24
P14-78	P14-59	266	24	P15-41	P15-61	287	24
P15-1	P15-21	270	24	P15-42	P15-62	284	24
P15-2	P15-22	271	24	P15-45	P15-65	285	24
P15-3	P15-23	272	24	P15-49	P15-54	286	24
P15-4	P15-24	273	24	P15-54	P15-49	286	24
P15-5	P15-25	274	24	P15-60	P2-K2	123	24
P15-6	P15-26	275	24	P15-61	P15-41	287	24
P15-7	P15-27	276	24	P15-62	P15-42	284	24
P15-8	P15-28	277	24	P15-65	P15-45	285	24
P15-9	P15-29	278	24	P15-68	P2-L3	130	24
P15-11	P15-31	279	24	P15-69	P2-L1	127	24
P15-12	P15-13	280	24	P15-73	P2-L4	131	24
P15-13	P15-12	280	24	P15-74	P2-L2	128	24
P15-15	P15-35	281	24	P16-1	P2-M6	139	24
P15-17	P15-36	282	24	P16-2	P1-U6	31	24
P15-19	P2-L6	133	24	P16-3	P2-M5	138	24
P15-20	P15-39	283	24	P16-6	P2-M3	136	24
P15-21	P15-1	270	24	P16-7	P2-M4	137	24
P15-22	P15-2	271	24	P16-8	P2-M1	134	24
P15-23	P15-3	272	24	P16-9	P2-M2	135	24
P15-24	P15-4	273	24				

CABLE ASSEMBLY 13083689-49 WIRE LIST

FROM	TO	WIRE ID	WIRE SIZE	FROM	TO	WIRE ID	WIRE SIZE
P1-A1	P5-5	1	24	P1-L3	P6-4	39	24
P1-A3	P5-111	2	24	P1-L4	P6-21	40	24
P1-A5	P5-89	3	24	P1-L5	P6-8	41	24
P1-B1	P5-4	4	24	P1-L6	P6-25	42	24
P1-B3	P5-87	5	24	P1-M2	P1-N3	52	24
P1-B5	P5-114	6	24	P1-M3	P2-b3	43	24
P1-C1	P5-117	7	24	P1-M4	P2-b2	44	24
P1-C3	P5-97	8	24	P1-M5	P2-C4	46	24
P1-C5	P5-105	9	24	P1-M5	P6-6	45	24
P1-D1	P5-103	10	24	P1-M6	P2-b1	47	24
P1-D3	P5-95	11	24	P1-N1	P1-a4	48	24
P1-D5	P5-102	12	24	P1-N2	P1-a2	50	24
P1-E1	P5-60	13	24	P1-N3	P1-M2	52	24
P1-E3	P5-45	14	24	P1-N3	P3-E	53	24
P1-E5	P5-35	15	24	P1-N4	P2-c6	54	24
P1-F1	P5-40	16	24	P1-N5	P2-c5	55	24
P1-H2	P2-N1	17	24	P1-N6	P2-c4	56	24
P1-H3	P1-V6	18	24	P1-R1	P6-22	57	24
P1-H4	P2-N3	19	24	P1-R2	P7-26	58	24
P1-H5	P2-N4	20	24	P1-R3	P7-22	59	24
P1-H6	P2-N5	197	24	P1-R5	P7-5	60	24
P1-J1	P1-V5	21	24	P1-S5	P6-5	61	24
P1-J2	P2-B4	23	24	P1-S6	P7-9	62	24
P1-J3	P6-19	25	24	P1-U1	P6-2	63	24
P1-J4	P6-20	26	24	P1-U1	P1-K3	33	24
P1-J5	P2-E4	27	24	P1-U2	P6-18	64	24
P1-J6	P7-2	29	24	P1-U2	P1-K4	34	24
P1-J6	P2-B6	28	24	P1-V1	P4-38	65	24
P1-K1	P2-c1	30	24	P1-V2	P4-39	66	24
P1-K2	P6-1	31	24	P1-V4	P4-46	67	24
P1-K2	P2-N2	136	24	P1-V5	P7-6	22	24
P1-K3	P6-2	32	24	P1-V5	P1-J1	21	24
P1-K3	P1-U1	33	24	P1-V6	P7-3	68	24
P1-K4	P1-U2	34	24	P1-V6	P1-H3	18	24
P1-K4	P6-18	35	24	P1-W1	P4-34	69	24
P1-K5	P2-F4	198	24	P1-W2	P4-35	70	24
P1-K6	P2-F6	36	24	P1-W3	P4-32	71	24
P1-L1	P2-c3	37	24	P1-W4	P4-33	72	24
P1-L2	P2-c2	38	24	P1-W5	P4-36	73	24
				P1-W6	P4-37	74	24

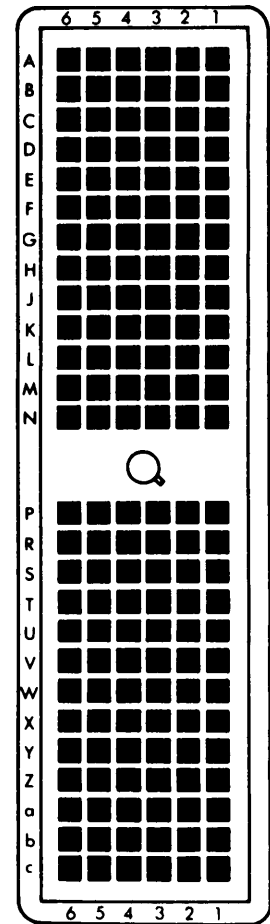

EL9LQ-1000-82A

P1 and P2 - DL1-156P



CABLE ASSEMBLY 13083689-49 WIRE LIST (cont)

FROM	TO	WIRE ID	WIRE SIZE	FROM	TO	WIRE ID	WIRE SIZE
P1-Y1	P3-KK	75	24	P2-J2	P10-10	120	24
P1-Y3	P3-w	76	24	P2-J3	P4-28	121	24
P1-Y4	P3-h	77	24	P2-J4	P4-91	122	24
P1-Y5	P3-v	78	24	P2-J5	P8-39	123	24
P1-Z2	P3-V	79	24	P2-J6	P8-40	124	24
P1-Z6	P3-m	80	24	P2-K1	P10-3	125	24
P1-a2	P3-BB	51	24	P2-K2	P10-4	126	24
P1-a2	P1-N2	50	24	P2-K3	P10-5	127	24
P1-a4	P3-a	49	24	P2-K4	P10-6	128	24
P1-a4	P1-N1	48	24	P2-K5	P10-7	129	24
P2-A2	P2-a5	81	24	P2-K6	P10-8	130	24
P2-A6	P9-2	82	24	P2-L1	P9-28	131	24
P2-B2	P2-a4	83	24	P2-L5	P10-1	132	24
P2-B4	P7-11	24	24	P2-L6	P10-2	133	24
P2-B4	P1-J2	23	24	P2-M2	P8-26	134	24
P2-B6	P1-J6	28	24	P2-N1	P7-18	135	24
P2-C2	P2-a3	84	24	P2-N1	P1-H2	17	24
P2-C4	P1-M5	46	24	P2-N2	P1-K2	136	24
P2-C5	P5-14	85	24	P2-N3	P7-19	137	24
P2-C6	P6-19	86	24	P2-N3	P1-H4	19	24
P2-D1	P5-124	87	24	P2-N4	P7-20	138	24
P2-D3	P5-25	88	24	P2-N4	P1-H5	20	24
P2-D5	P5-33	89	24	P2-N5	P1-H6	197	24
P2-D6	P6-20	90	24	P2-S5	P5-54	139	24
P2-E3	P5-19	91	24	P2-T1	P9-17	140	24
P2-E4	P7-1	92	24	P2-T3	P9-18	141	24
P2-E4	P1-J5	27	24	P2-U1	P5-56	142	24
P2-E5	P5-22	93	24	P2-U2	P3-c	143	24
P2-E6	P9-8	94	24	P2-U3	P5-58	150	24
P2-F1	P5-2	95	24	P2-U5	P5-57	151	24
P2-F2	P5-3	96	24	P2-U6	P3-b	152	24
P2-F3	P5-13	106	24	P2-V1	P2-V2	157	24
P2-F4	P6-3	115	24	P2-V1	P2-G6	116	24
P2-F4	P1-K5	198	24	P2-V2	P2-V1	157	24
P2-F6	P1-K6	36	24	P2-a3	P2-C2	84	24
P2-G6	P2-V1	116	24	P2-a4	P2-B2	83	24
P2-H1	P5-65	117	24	P2-a5	P2-A2	81	24
P2-H2	P4-48	118	24	P2-b1	P1-M6	47	24
P2-J1	P10-9	119	24	P2-b2	P1-M4	44	24

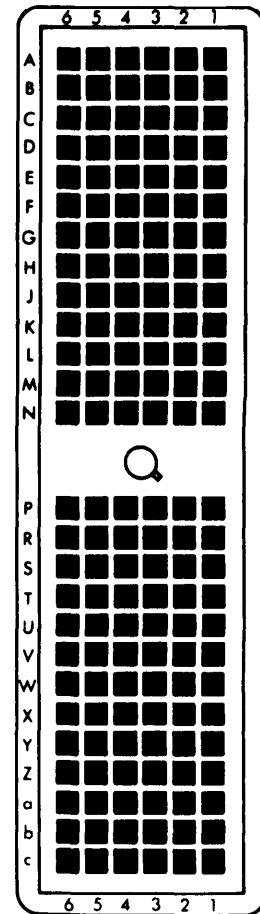

EL9LQ-1000-82A

P1 and P2 - DL1-156P

3-32. TPS CABLE ASSEMBLIES (cont)

CABLE ASSEMBLY 13083689-49 WIRE LIST (cont)

FROM	TO	WIRE ID	WIRE SIZE	FROM	TO	WIRE ID	WIRE SIZE
P2-b3	P1-M3	43	24				
P2-c1	P1-K1	30	24				
P2-c2	P1-L2	38	24				
P2-c3	P1-L1	37	24				
P2-c4	P1-N6	56	24				
P2-c5	P1-N5	55	24				
P2-c6	P1-N4	54	24				
P3-E	P1-N3	53	24				
P3-F	P4-50	158	24				
P3-F	P3-LL	156	24				
P3-V	P1-Z2	79	24				
P3-a	P1-a4	49	24				
P3-b	P3-CC	153	24				
P3-b	P2-U6	152	24				
P3-c	P3-x	144	24				
P3-c	P2-U2	143	24				
P3-h	P1-Y4	77	24				
P3-m	P1-Z6	80	24				
P3-v	P1-Y5	78	24				
P3-w	P1-Y3	76	24				
P3-x	P5-1	145	24				
P3-x	P3-c	144	24				
P3-BB	P1-a2	51	24				
P3-CC	P3-FF	154	24				
P3-CC	P3-b	153	24				
P3-FF	P3-LL	155	24				
P3-FF	P3-CC	154	24				
P3-KK	P1-Y1	75	24				
P3-LL	P3-F	156	24				
P3-LL	P3-FF	155	24				
P4-28	P2-J3	121	24				
P4-29	P4-79	161	24				
P4-32	P1-W3	71	24				
P4-33	P1-W4	72	24				
P4-34	P1-W1	69	24				
P4-35	P1-W2	70	24				
P4-36	P1-W5	73	24				
P4-37	P1-W6	74	24				
P4-38	P1-V1	65	24				
P4-39	P1-V2	66	24				

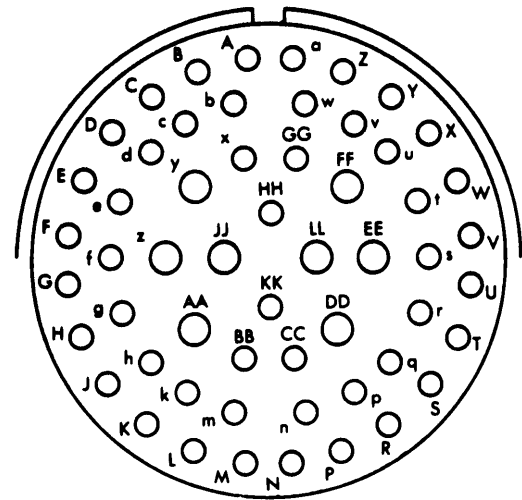

EL9LQ-1000-79

**P3 - MS27467T25B4S**

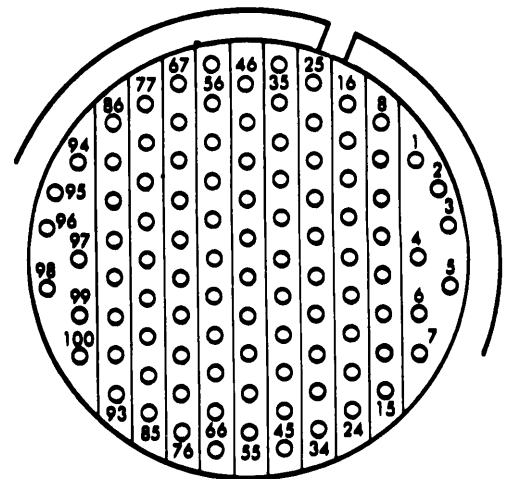

EL9LQ-1000-3A

**P4 - MS27467T23F35SA**

CABLE ASSEMBLY 13083689-49 WIRE LIST (cont)

FROM	TO	WIRE ID	WIRE SIZE	FROM	TO	WIRE ID	WIRE SIZE
P4-46	P1-V4	67	24	P5-33	P2-D5	89	24
P4-48	P2-H2	118	24	P5-34	P5-43	109	24
P4-50	P4-80	159	24	P5-34	P5-32	108	24
P4-50	P3-F	158	24	P5-35	P1-E5	15	24
P4-75	P4-92	162	24	P5-36	P5-64	169	24
P4-76	P4-80	160	24	P5-37	P5-51	149	24
P4-79	P4-29	161	24	P5-37	P5-21	148	24
P4-80	P4-76	160	24	P5-38	P5-39	170	24
P4-80	P4-50	159	24	P5-39	P5-38	170	24
P4-91	P2-J4	122	24	P5-40	P1-F1	16	24
P4-92	P4-75	162	24	P5-41	P5-42	171	24
P5-1	P5-11	146	24	P5-42	P5-41	171	24
P5-1	P3-x	145	24	P5-43	P5-61	110	24
P5-2	P2-F1	95	24	P5-43	P5-34	109	24
P5-3	P5-83	97	24	P5-45	P1-E3	14	24
P5-3	P2-F2	96	24	P5-46	P5-30	168	24
P5-4	P1-B1	4	24	P5-49	P5-50	172	24
P5-5	P1-A1	1	24	P5-50	P5-49	172	24
P5-6	P5-109	163	24	P5-51	P5-100	173	24
P5-11	P5-21	147	24	P5-51	P5-37	149	24
P5-11	P5-1	146	24				
P5-12	P5-55	175	24				
P5-13	P5-32	107	24				
P5-13	P2-F3	106	24				
P5-14	P2-C5	85	24				
P5-17	P5-20	164	24				
P5-19	P2-E3	91	24				
P5-20	P5-17	164	24				
P5-21	P5-37	148	24				
P5-21	P5-11	147	24				
P5-22	P2-E5	93	24				
P5-23	P5-24	165	24				
P5-24	P5-23	165	24				
P5-25	P2-D3	88	24				
P5-26	P5-127	166	24				
P5-27	P5-28	167	24				
P5-28	P5-27	167	24				
P5-30	P5-46	168	24				
P5-32	P5-34	108	24				
P5-32	P5-13	107	24				

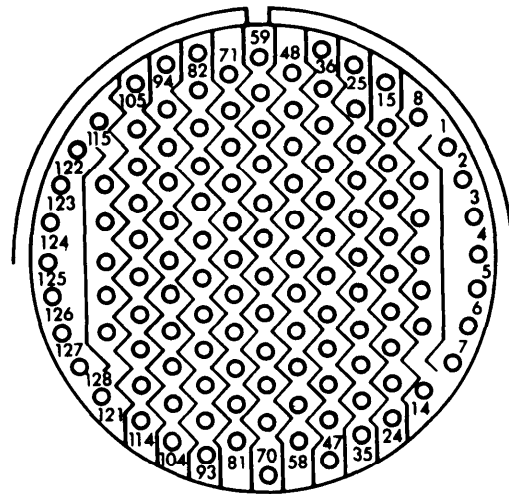

EL9LQ-1000-2

P5 - MS27467T25F35S

3-32. TPS CABLE ASSEMBLIES (cont)

3-32

CABLE ASSEMBLY 13083689-49 WIRE LIST (cont)

FROM	TO	WIRE ID	WIRE SIZE	FROM	TO	WIRE ID	WIRE SIZE
P5-52	P5-53	176	24	P5-105	P1-C5	9	24
P5-53	P5-52	176	24	P5-106	P5-92	179	24
P5-54	P2-S5	139	24	P5-107	P5-88	178	24
P5-55	P5-12	175	24	P5-108	P5-110	104	24
P5-55	P5-100	174	24	P5-108	P5-104	103	24
P5-56	P2-U1	142	24	P5-109	P5-6	163	24
P5-57	P2-U5	151	24	P5-110	P5-116	105	24
P5-58	P2-U3	150	24	P5-110	P5-108	104	24
P5-60	P1-E1	13	24	P5-111	P1-A3	2	24
P5-61	P5-81	111	24	P5-112	P5-113	182	24
P5-61	P5-43	110	24	P5-113	P5-112	182	24
P5-64	P5-36	169	24	P5-114	P1-B5	6	24
P5-65	P2-H1	117	24	P5-115	P5-118	183	24
P5-81	P5-82	112	24	P5-116	P5-110	105	24
P5-81	P5-61	111	24	P5-117	P1-C1	7	24
P5-82	P5-123	113	24	P5-118	P5-115	183	24
P5-82	P5-81	112	24	P5-119	P5-120	184	24
P5-83	P5-85	98	24	P5-120	P5-119	184	24
P5-83	P5-3	97	24	P5-123	P5-126	114	24
P5-85	P5-90	99	24	P5-123	P5-82	113	24
P5-85	P5-83	98	24	P5-124	P2-D1	87	24
P5-86	P5-98	177	24	P5-126	P5-123	114	24
P5-87	P1-B3	5	24	P5-127	P5-26	166	24
P5-88	P5-107	178	24	P6-1	P1-K2	31	24
P5-89	P1-A5	3	24	P6-2	P1-U1	63	24
P5-90	P5-91	100	24	P6-2	P1-K3	32	24
P5-90	P5-85	99	24	P6-3	P2-F4	115	24
P5-91	P5-94	101	24	P6-4	P1-L3	39	24
P5-91	P5-90	100	24	P6-5	P1-S5	61	24
P5-92	P5-106	179	24	P6-6	P1-M5	45	24
P5-93	P5-96	180	24	P6-8	P1-L5	41	24
P5-94	P5-104	102	24	P6-18	P1-U2	64	24
P5-94	P5-91	101	24	P6-18	P1-K4	35	24
P5-95	P1-D3	11	24	P6-19	P1-J3	25	24
P5-96	P5-93	180	24	P6-19	P2-C6	86	24
P5-97	P1-C3	8	24				
P5-98	P5-86	177	24				
P5-99	P5-101	181	24				
P5-100	P5-55	174	24				
P5-100	P5-51	173	24				
P5-101	P5-99	181	24				
P5-102	P1-D5	12	24				
P5-103	P1-D1	10	24				
P5-104	P5-108	103	24				
P5-104	P5-94	102	24				

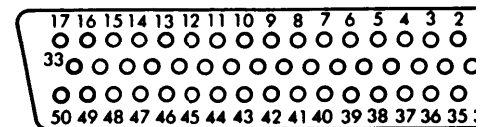

EL9LQ-1C

**P6-M24308/2-5 F**

CABLE ASSEMBLY 13083689-49 WIRE LIST (cont)

FROM	TO	WIRE ID	WIRE SIZE	FROM	TO	WIRE ID	WIRE SIZE
P6-20	P1-J4	26	24	P9-16	P9-15	193	24
P6-20	P2-D6	90	24	P9-17	P2-T1	140	24
P6-21	P1-L4	40	24	P9-18	P2-T3	141	24
P6-22	P1-R1	57	24	P9-19	P9-20	194	24
P6-25	P1-L6	42	24	P9-20	P9-19	194	24
P7-1	P2-E4	92	24	P9-23	P9-31	195	24
P7-2	P1-J6	29	24	P9-24	P9-12	191	24
P7-3	P1-V6	68	24	P9-25	P9-30	196	24
P7-5	P1-R5	60	24	P9-26	P9-5	187	24
P7-6	P1-V5	22	24	P9-27	P9-14	192	24
P7-9	P1-S6	62	24	P9-28	P2-L1	131	24
P7-11	P2-B4	24	24	P9-29	P9-4	188	24
P7-18	P2-N1	135	24	P9-30	P9-25	196	24
P7-19	P2-N3	137	24	P9-31	P9-23	195	24
P7-20	P2-N4	138	24				
P7-22	P1-R3	59	24				
P7-26	P1-R2	58	24				
P8-26	P2-M2	134	24				
P8-39	P2-J5	123	24				
P8-40	P2-J6	124	24				
P9-1	P9-13	185	24				
P9-2	P2-A6	82	24				
P9-3	P9-5	186	24				
P9-4	P9-29	188	24				
P9-5	P9-26	187	24				
P9-5	P9-3	186	24				
P9-6	P9-7	189	24				
P9-7	P9-6	189	24				
P9-8	P2-E6	94	24				
P9-9	P9-11	190	24				
P9-11	P9-9	190	24				
P9-12	P9-24	191	24				
P9-13	P9-1	185	24				
P9-14	P9-27	192	24				
P9-15	P9-16	193	24				

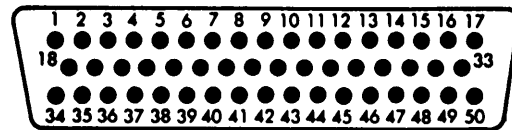

EL9LQ-1000-13

P7 and P8-M24308/4-5 F

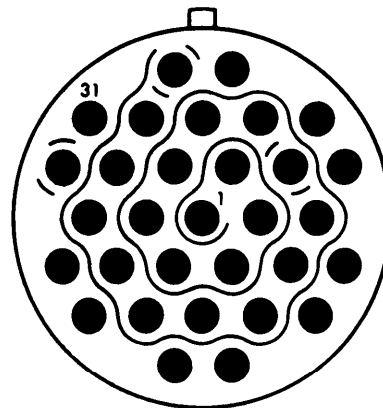

EL9LQ-1000-77A

P9 - M83723/81H1831N

CABLE ASSEMBLY 13083689-49 WIRE LIST (cont)

FROM	TO	WIRE ID	WIRE SIZE
P10-1	P2-L5	132	24
P10-2	P2-L6	133	24
P10-3	P2-K1	125	24
P10-4	P2-K2	126	24
P10-5	P2-K3	127	24
P10-6	P2-K4	128	24
P10-7	P2-K5	129	24
P10-8	P2-K6	130	24
P10-9	P2-J1	119	24
P10-10	P2-J2	120	24

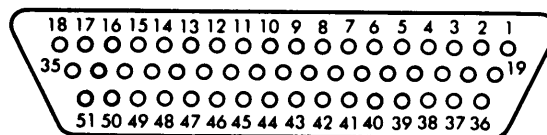

EL9LQ-1000-98

P10 - MDM-51SSB



CABLE ASSEMBLY 13083693-19 WIRE LIST

FROM	TO	WIRE SIZE	FROM	TO	WIRE SIZE
P1-A3	P4-46	26	P1-N1	SPL20	20
P1-A5	P4-22	26	P1-N2	P2-D4	24
P1-B1	P4-5	26	P1-N3	P1-Y5	24
P1-B3	P4-6	26	P1-N4	SPL2	20
P1-B5	P4-23	26	P1-N5	SPL4	20
P1-C1	P4-39	26	P1-N6	SPL2	20
P1-C3	P4-30	26	P1-P5	P2-U5	24
P1-C5	P4-41	26	P1-P6	P2-V1	24
P1-D1	SPL13	24	P1-R1	P1-U6	24
P1-E3	SPL14	45	P1-R1	P3-2	24
P1-E4	P1-X6	24	P1-R2	P2-U3	24
P1-G1	P1-J1	24	P1-R3	P1-a3	24
P1-F1	P1-J1	24	P1-R3	P3-37	24
P1-F1	P4-42	26	P1-R4	P1-a4	24
P1-H2	P3-70	22	P1-R4	P3-36	26
P1-H3	P3-71	22	P1-R5	P3-52	24
P1-H4	P4-9	26	P1-R5	P1-Z1	24
P1-H4	P2-M6	24	P1-R6	P3-53	24
P1-J1	P1-F1	24	P1-R6	P1-Z2	24
P1-J2	P1-L1	26	P1-S1	P2-S5	24
P1-J2	P3-42	22	P1-S2	P2-T1	24
P1-J4	P3-43	22	P1-S3	P2-T3	24
P1-J5	P3-46	22	P1-S4	P2-T5	24
P1-J6	P3-67	33	P1-S5	P2-E5	24
P1-K1	P4-29	26	P1-S6	P2-U1	24
P1-K2	P4-31	26	P1-T1	P2-A6	24
P1-K5	P3-47	22	P1-T2	P2-N6	24
P1-K6	P3-66	22	P1-T3	P2-D3	24
P1-L1	P1-J2	26	P1-T4	P2-B6	24
P1-L2	P1-Z4	26	P1-T5	P2-E1	24
P1-L2	P3-22	22	P1-T6	P2-E3	24
P1-L3	P1-L4	26	P1-U1	STP3	24
P1-L3	P1-Z5	26	P1-U2	P4-17	26
P1-L4	P1-L3	26	P1-U3	P3-59	24
P1-L4	P3-21	22	P1-U4	P3-58	24
P1-L5	SPL23	22	P1-U5	P4-18	26
P1-L6	SPL21	24	P1-U6	P1-R1	24
P1-M1	SPL5	20	P1-V1	P4-40	26
P1-M2	SPL7	20	P1-V2	P4-48	26
P1-M3	SPL17	20	P1-V3	P4-43	26
P1-M4	SPL19	22	P1-V4	P4-44	26
P1-M5	SPL18	20	P1-V5	P3-74	24
P1-M6	SPL4	20	P1-V6	P3-50	22

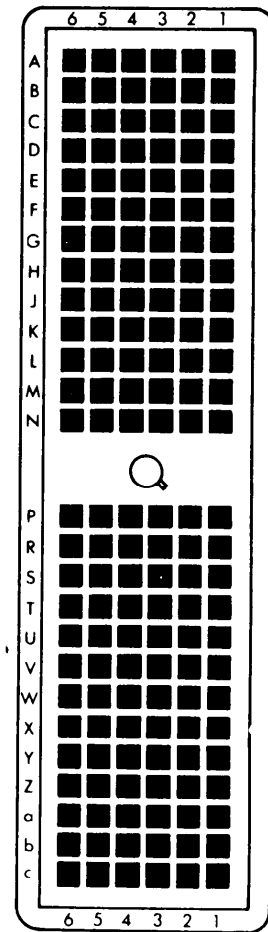

EL9LQ-1000-82A

P1 and P2 - DL1-156P



## 3-32. TPS CABLE ASSEMBLIES (cont)

3-32

## CABLE ASSEMBLY 13083693-19 WIRE LIST (cont)

FROM	TO	WIRE SIZE	FROM	TO	WIRE SIZE
P1-W1	P3-32	24	P2-B6	P1-T4	24
P1-W2	SPL 9	20	P2-C2	P2-C4	24
P1-W3	SPL 10	24	P2-C4	P2-C2	24
P1-W4	P4-10	26	P2-C6	P6-5	24
P1-W5	P4-11	26	P2-D1	P4-32	24
P1-W6	P4-12	26	P2-D3	P1-T3	24
P1-X1	P3-15	24	P2-D4	P1-N2	24
P1-X2	P3-18	24	P2-D6	P6-6	24
P1-X3	P3-34	24	P2-E1	P1-T5	24
P1-X4	P3-51	22	P2-E2	P2-E4	24
P1-X5	P3-33	24	P2-E3	P1-T6	24
P1-X6	P1-E4	24	P2-E4	P2-E2	24
P1-X6	P3-12	24	P2-E5	P1-S5	24
P1-Y1	P4-47	26	P2-E6	P6-7	24
P1-Y2	STP8	24	P2-F6	P6-8	24
P1-Y3	P3-54	24	P2-G1	P3-19	24
P1-Y4	STP10	24	P2-G2	P3-60	24
P1-Y5	P3-13	24	P2-G3	P3-10	24
P1-Y5	P1-N3	24	P2-G4	P3-68	24
P1-Y6	P3-14	24	P2-G5	P3-69	24
P1-Z1	P1-b2	24	P2-G6	P3-17	24
P1-Z1	P1-R5	24	P2-H1	P6-1	24
P1-Z2	P1-b3	24	P2-H2	P3-61	24
P1-Z2	P1-R6	24	P2-H4	P6-2	24
P1-Z3	STP1	24	P2-H5	P6-3	24
P1-Z4	P1-L2	26	P2-H6	P6-4	24
P1-Z5	P1-L3	26	P2-J1	SPL 4	24
P1-Z6	P4-45	26	P2-J2	SPL 15	24
P1-a1	P3-55	22	P2-J3	SPL 16	24
P1-a1	P2-L3	26	P2-J4	SPL 6	24
P1-a2	P3-56	22	P2-J5	SPL 8	24
P1-a2	P2-L1	26	P2-J6	SPL 11	24
P1-a3	P1-R3	24	P2-K1	P4-28	26
P1-a4	P1-R4	24	P2-K2	P4-13	26
P1-a5	P3-31	24	P2-K3	P4-24	26
P1-a6	P3-30	24	P2-K4	P4-26	26
P1-b2	P1-Z1	24	P2-K5	P4-25	26
P1-b3	P1-Z2	24	P2-K6	SPL 2	26
P2-A4	P6-9	24	P2-L1	P1-a2	26
P2-A6	P1-T1	24	P2-L2	P3-75	26
P2-B2	P2-B4	24	P2-L3	P1-a1	26
P2-B4	P2-B2	24			

CABLE ASSEMBLY 13083693-19 WIRE LIST (cont)

FROM	TO	WIRE SIZE	FROM	TO	WIRE SIZE
P2-L4	P4-37	26	P3-15	P1-X1	24
P2-L5	P3-57	24	P3-17	P2-G6	24
P2-L6	P4-27	26	P3-18	P1-X2	24
P2-M1	P4-19	26	P3-19	P2-G1	24
P2-M2	P4-20	26	P3-21	P1-L4	22
P2-M3	P4-36	26	P3-22	P1-L2	22
P2-M4	P4-7	26	P3-23	SPL16	22
P2-M5	P4-8	26	P3-26	SPL6	22
P2-M6	P1-H4	24	P3-27	SPL8	22
P2-N1	P3-45	24	P3-28	P2-N2	22
P2-N2	P3-28	22	P3-29	P2-N5	22
P2-N3	P3-77	24	P3-30	P1-a6	24
P2-N4	P3-78	24	P3-31	P1-a5	24
P2-N5	P3-29	22	P3-32	P1-W1	24
P2-N6	P1-T2	24	P3-33	P1-X5	24
P2-S5	P1-S1	24	P3-34	P1-X3	24
P2-T1	P3-5	24	P3-35	STP11	24
P2-T1	P1-S2	24	P3-36	P3-3	26
P2-T3	P1-S3	24	P3-36	P1-R4	26
P2-T5	P1-S4	24	P3-37	P1-R3	24
P2-U1	P1-S6	24	P3-41	STP2	24
P2-U3	P1-R2	24	P3-41	STP4	24
P2-U5	P1-P5	24	P3-42	P1-J2	22
P2-V1	P1-P6	24	P3-43	P1-J4	22
P2-b1	SPL23	22	P3-44	SPL11	22
P2-b2	SPL24	22	P3-45	P2-N1	24
P2-b4	SPL26	24	P3-46	P1-J5	22
P2-b5	SPL25	24	P3-47	P1-K5	22
P2-c1	SPL21	20	P3-50	P1-V6	22
P2-c2	SPL21	24	P3-51	P1-X4	22
P3-1	SPL12	22	P3-52	P1-R5	24
P3-2	P1-R1	24	P3-53	P1-R6	24
P3-3	P3-36	26	P3-54	P1-Y3	24
P3-4	SPL15	22	P3-55	P1-a1	22
P3-5	P2-T1	24	P3-56	P1-a2	22
P3-6	SPL2	22	P3-57	P2-L5	24
P3-7	SPL4	22	P3-58	P1-U4	24
P3-8	SPL13	22	P3-59	P1-U3	24
P3-9	SPL14	45	P3-60	P2-G2	24
P3-10	P2-G3	24	P3-61	P2-H2	24
P3-12	P1-X6	24	P3-63	SPL10	22
P3-13	P1-Y5	24	P3-64	SPL9	22
P3-14	P1-Y6	24			

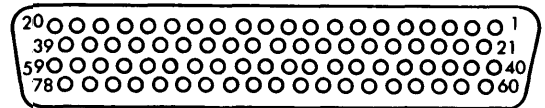

EL9LQ-1000-69

P3-M24308/2-15F



CABLE ASSEMBLY 13083693-19 WIRE LIST (cont)

FROM	TO	WIRE SIZE	FROM	TO	WIRE SIZE
P3-66	P1-K6	22	P4-44	P1-V4	26
P3-67	P1-J6	22	P4-45	P1-Z6	26
P3-68	P2-G4	24	P4-46	P1-A3	26
P3-69	P2-G5	24	P4-47	P1-Y1	26
P3-70	P1-H2	22	P4-48	P1-V2	26
P3-71	P1-H3	22	P5	P3-76	COAX
P3-74	P1-V5	24	P6-1	P2-H1	24
P3-75	STP12	24	P6-2	P2-H4	24
P3-75	P2-L2	26	P6-3	P2-H5	24
P3-76	P5	COAX	P6-4	P2-H6	24
P3-77	P2-N3	24	P6-5	P2-C6	24
P3-78	P2-N4	24	P6-6	P2-D6	24
P4-5	P1-B1	26	P6-7	P2-E6	24
P4-6	P1-B3	26	P6-8	P2-F6	24
P4-7	P2-M4	26	P6-9	P2-A4	24
P4-8	P2-M5	26	SPL 2	P1-N6	20
P4-9	P1-H4	26	SPL 2	P1-N4	20
P4-10	P1-W4	26	SPL 2	P2-K6	26
P4-11	P1-W5	26	SPL 2	P3-6	22
P4-12	P1-W6	26	SPL 4	P1-N5	20
P4-13	P2-K2	26	SPL 4	P1-M6	20
P4-17	P1-U2	26	SPL 4	P2-J1	24
P4-18	P1-U5	26	SPL 4	P3-7	22
P4-19	P2-M1	26	SPL 5	P1-M1	20
P4-20	P2-M2	26	SPL 5	SPL 6	20
P4-22	P1-A5	26	SPL 6	SPL 5	20
P4-23	P1-B5	26	SPL 6	P2-J4	24
P4-24	P2-K3	26	SPL 6	P3-26	22
P4-25	P2-K5	26	SPL 7	P1-M2	20
P4-26	P2-K4	26	SPL 7	SPL 8	20
P4-27	P2-L6	26	SPL 8	SPL 7	20
P4-28	P2-K1	26	SPL 8	P3-27	22
P4-29	P1-K1	26	SPL 8	P2-J5	24
P4-30	P1-C3	26	SPL 9	P1-W2	24
P4-31	P1-K2	26	SPL 9	SPL 17	20
P4-32	P2-D1	26	SPL 9	P3-64	20
P4-36	P2-M3	26	SPL 10	P1-W3	24
P4-37	P2-L4	26	SPL 10	SPL 18	20
P4-39	P1-C1	26	SPL 10	P3-63	22
P4-40	P1-V1	26	SPL 11	SPL 19	20
P4-41	P1-C5	26	SPL 11	P3-44	22
P4-42	P1-F1	26	SPL 11	P2-J6	24
P4-43	P1-V3	26	SPL 12	STP5	24
			SPL 12	STP6	24

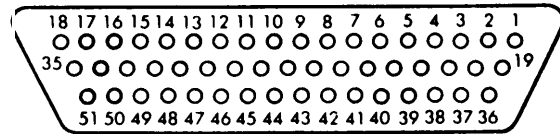

EL9LQ-1000-98

P4 - MDM-51SSP

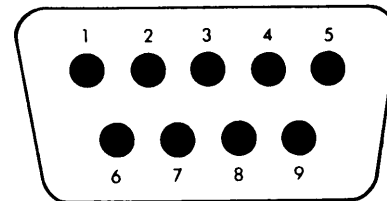

EL9LQ-1000-10

P6-M24308/4-1F



## 3-32. TPS CABLE ASSEMBLIES (cont)

3-32

## CABLE ASSEMBLY 13083693-19 WIRE LIST (cont)

FROM	TO	WIRE SIZE	FROM	TO	WIRE SIZE
SPL 12	STP7	24	SPL 21	P1-L6	20
SPL 12	STP9	22	SPL 21	P2-c1	20
SPL 12	P3-1	22	SPL 21	P2-c2	22
SPL 13	SPL 20	20	SPL 23	P1-L5	22
SPL 13	P1-D1	24	SPL 23	P2-b1	22
SPL 13	P3-8	22	SPL 23	SPL 14	20
SPL 14	SPL 23	20	SPL 24	SPL 14	20
SPL 14	SPL 24	20	SPL 24	P2-b2	22
SPL 14	P1-E3	22	SPL 25	P2-b5	24
SPL 14	P3-9	22	SPL 25	SPL 15	20
SPL 15	P2-J2	24	SPL 26	P2-b4	24
SPL 15	SPL 25	20	SPL 26	SPL 16	20
SPL 15	P3-4	22	STP1	P1-Z3	24
SPL 16	P2-J3	24	STP2	P3-41	24
SPL 16	SPL 26	20	STP3	P1-U1	24
SPL 16	P3-23	22	STP4	P3-41	24
SPL 17	P1-M3	20	STP5	SPL 12	24
SPL 17	SPL 9	20	STP6	SPL 12	24
SPL 18	P1-M5	22	STP7	SPL 12	24
SPL 18	SPL 10	20	STP8	P1-Y2	24
SPL 19	P1-M4	22	STP9	SPL 12	22
SPL 19	SPL 11	20	STP10	P1-Y4	24
SPL 20	P1-N1	20	STP11	P3-35	24
SPL 20	SPL 13	20	STP12	P3-75	24

CABLE ASSEMBLY 13083693-29 WIRE LIST

FROM	TO	WIRE SIZE	FROM	TO	WIRE SIZE
P1-A1	P4-25	26	P1-N4	SPL 3	20
P1-A3	P4-46	26	P1-N5	SPL 13	20
P1-A5	P4-22	26	P1-N6	SPL 3	20
P1-B1	P4-5	26	P1-U1	P3-38	24
P1-B3	P4-6	26	P1-U2	P4-17	26
P1-B5	P4-23	26	P1-U3	P3-60	24
P1-C1	P4-49	26	P1-U3	P1-H6	24
P1-C5	P4-50	26	P1-U4	P3-61	24
P1-D1	P4-34	26	P1-U4	P1-J3	24
P1-D3	P4-15	26	P1-U5	P4-18	26
P1-D5	P4-16	26	P1-U6	P4-42	26
P1-E1	P4-35	26	P1-V3	P3-8	24
P1-E2	P1-W4	24	P1-V4	P2-A2	24
P1-E2	SPL 5	24	P1-V4	P3-41	24
P1-E3	P4-33	26	P1-V5	P1-E6	26
P1-E5	P4-14	26	P1-V6	P3-40	24
P1-E6	P1-V5	26	P1-V6	P1-H5	24
P1-E6	STP6	26	P1-W1	P3-32	24
P1-F1	P4-41	26	P1-W2	SPL 12	26
P1-F1	P1-J1	24	P1-W3	SPL 10	26
P1-H5	P1-V6	24	P1-W4	P1-E2	24
P1-H6	P1-U3	24	P1-X1	P3-19	24
P1-J1	P1-F1	24	P1-X2	P4-11	26
P1-J3	P1-U4	24	P1-X3	P3-26	24
P1-J4	P3-74	24	P1-X4	P2-B2	24
P1-K1	P4-29	26	P1-X5	P3-29	24
P1-K2	P4-31	26	P1-X6	P4-12	26
P1-K3	P2-L4	24	P1-Y1	P4-47	26
P1-K4	P2-L6	24	P1-Y2	P4-10	26
P1-L1	P3-1	22	P1-Y3	P3-6	24
P1-L2	P3-21	22	P1-Y4	P3-9	24
P1-L3	SPL 4	22	P1-Y5	P3-13	24
P1-L4	SPL 4	22	P1-Y6	P3-16	24
P1-L5	SPL 25	20	P1-Z1	P3-5	24
P1-L6	SPL 24	20	P1-Z2	P3-25	24
P1-M1	SPL 1	20	P1-Z3	P4-7	26
P1-M2	SPL 14	20	P1-Z4	P4-8	26
P1-M3	SPL 11	20	P1-Z5	P4-9	26
P1-M4	SPL 7	20	P1-Z6	P4-45	26
P1-M5	SPL 9	20	P1-a1	P2-L3	26
P1-M6	SPL 13	20	P1-a1	P3-31	22
P1-N1	SPL 22	20	P1-a2	P2-L1	24

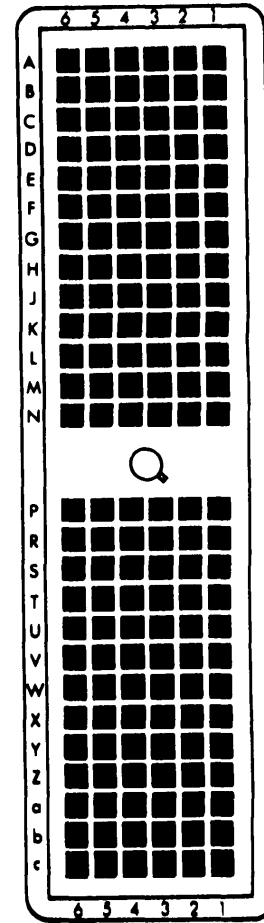

EL9LQ-1000-82A

P1 and P2 - DL1-156P

3-32. TPS CABLE ASSEMBLIES (cont)

3-32

CABLE ASSEMBLY 13083693-29 WIRE LIST (cont)

FROM	TO	WIRE SIZE	FROM	TO	WIRE SIZE
P1-a2	P3-11	22	P2-T1	P3-77	22
P1-a3	P3-42	24	P2-T3	P4-30	26
P1-a4	P3-62	24	P2-T5	P4-32	26
P1-a5	P3-10	24	P2-U1	P4-21	26
P1-a6	P3-30	24	P2-U3	P4-38	26
P2-A2	P1-V4	24	P2-U5	P4-3	26
P2-B2	P1-X4	24	P2-V1	P4-4	26
P2-C5	P4-39	26	P2-b1	SPL 25	20
P2-D1	P4-40	26	P2-b2	SPL 26	20
P2-D5	P4-27	26	P2-b4	SPL 16	20
P2-E3	P4-28	26	P2-b5	SPL 21	20
P2-F1	P4-26	26	P2-c1	SPL 24	20
P2-H2	SPL 23	26	P2-c2	SPL 24	20
P2-H3	SPL 26	26	P3-1	P1-L1	22
P2-J1	SPL 3	26	P3-2	SPL 10	22
P2-J2	SPL 20	26	P3-3	SPL 8	22
P2-J3	SPL 17	26	P3-4	SPL 20	22
P2-J4	SPL 2	26	P3-5	P1-Z1	24
P2-J5	SPL 15	26	P3-6	P1-Y3	24
P2-J6	SPL 8	26	P3-7	P5	COAX
P2-K2	P4-13	26	P3-8	P1-V3	24
P2-K3	P4-24	26	P3-9	P1-Y4	24
P2-K4	P4-43	26	P3-10	P1-a5	24
P2-K5	P4-44	26	P3-11	P1-a2	22
P2-K6	SPL 13	26	P3-12	STP 7	26
P2-L1	P1-a2	24	P3-13	P1-Y5	24
P2-L2	P4-48	26	P3-14	SPL 13	22
P2-L3	P1-a1	26	P3-15	SPL 2	22
P2-L4	P3-48	24	P3-16	P1-Y6	24
P2-L4	P1-K3	24	P3-17	P2-N4	24
P2-L6	P3-70	24	P3-18	P2-N6	24
P2-L6	P1-K4	24	P3-19	P1-X1	24
P2-M1	SPL 18	20	P3-20	SPL 26	22
P2-M2	SPL 27	26	P3-21	P1-L2	22
P2-M6	P3-47	24	P3-22	SPL 12	22
P2-N1	P3-67	24	P3-23	SPL 6	22
P2-N2	P3-49	24	P3-24	SPL 17	22
P2-N3	P3-69	24	P3-25	P1-Z2	24
P2-N4	P3-17	24	P3-26	P1-X3	24
P2-N5	P3-37	24	P3-27	SPL 27	22
P2-N6	P3-18	24	P3-29	P1-X5	24

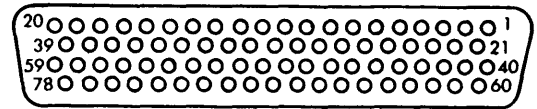

EL9LQ-1000-69

P3-M24308/2-15F



CABLE ASSEMBLY 13083693-29 WIRE LIST (cont)

FROM	TO	WIRE SIZE	FROM	TO	WIRE SIZE
P3-30	P1-a6	24	P4-21	P2-U1	26
P3-31	P1-a1	22	P4-22	P1-A5	26
P3-32	P1-W1	24	P4-23	P1-B5	26
P3-34	SPL 3	22	P4-24	P2-K3	26
P3-35	SPL 15	22	P4-25	P1-A1	26
P3-36	SPL 19	22	P4-26	P2-F1	26
P3-37	P2-N5	24	P4-27	P2-D5	26
P3-38	P1-U1	24	P4-28	P2-E3	26
P3-39	SPL 23	22	P4-29	P1-K1	26
P3-40	P1-V6	24	P4-30	P2-T3	26
P3-41	P1-V4	24	P4-31	P1-K2	26
P3-42	P1-a3	24	P4-32	P2-T5	26
P3-47	P2-M6	24	P4-33	P1-E3	26
P3-48	P2-L4	24	P4-34	P1-D1	26
P3-49	P2-N2	24	P4-35	P1-E1	26
P3-54	SPL 4	22	P4-38	P2-U3	26
P3-60	P1-U3	24	P4-39	P2-C5	26
P3-61	P1-U4	24	P4-40	P2-D1	26
P3-62	P1-a4	24	P4-41	P1-F1	26
P3-67	P2-N1	24	P4-42	P1-U6	26
P3-69	P2-N3	24	P4-43	P2-K4	26
P3-70	P2-L6	24	P4-44	P2-K5	26
P3-74	P1-J4	24	P4-45	P1-Z6	26
P3-77	P2-T1	22	P4-46	P1-A3	26
P4-3	P2-U5	26	P4-47	P1-Y1	26
P4-4	P2-V1	26	P4-48	P2-L2	26
P4-5	P1-B1	26	P4-49	P1-C1	26
P4-6	P1-B3	26	P4-50	P1-C5	26
P4-7	P1-Z3	26	P5	P3-7	COAX
P4-8	P1-Z4	26	SPL 1	SPL 2	20
P4-9	P1-Z5	26	SPL 1	P1-M1	20
P4-10	P1-Y2	26	SPL 2	SPL 1	20
P4-11	P1-X2	26	SPL 2	P2-J4	26
P4-12	P1-X6	26	SPL 2	P3-15	22
P4-13	P2-K2	26	SPL 3	P1-N6	20
P4-14	P1-E5	26	SPL 3	P1-N4	20
P4-15	P1-D3	26	SPL 3	P2-J1	20
P4-16	P1-D5	26	SPL 3	P3-34	22
P4-17	P1-U2	26	SPL 4	P1-L3	22
P4-18	P1-U5	26	SPL 4	P1-L4	22
			SPL 4	P3-54	22

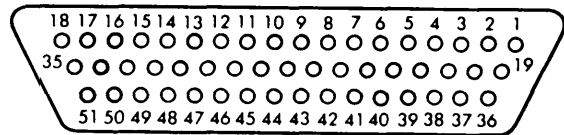

EL9LQ-1000-98



P4-MDMV51SSB

## 3-32. TPS CABLE ASSEMBLIES (cont)

3-32

## CABLE ASSEMBLY 13083693-29 HIRE LIST (cont)

FROM	TO	WIRE SIZE	FROM	TO	WIRE SIZE
SPL 5	STP1	22	SPL 18	P2-M1	20
SPL 5	STP3	22	SPL 18	SPL 19	20
SPL 5	P1-E2	24	SPL 19	SPL 18	20
SPL 6	STP2	24	SPL 19	P3-36	22
SPL 6	STP4	24	SPL 20	P2-J2	26
SPL 6	P3-23	22	SPL 20	SPL 21	20
SPL 7	P1-M4	20	SPL 20	P3-4	22
SPL 7	SPL 8	20	SPL 21	P2-b5	20
SPL 8	SPL 7	20	SPL 21	SPL 20	20
SPL 8	P2-J6	26	SPL 22	P1-N1	20
SPL 8	P3-3	22	SPL 22	SPL 23	20
SPL 9	P1-M5	20	SPL 23	SPL 22	20
SPL 9	SPL 10	20	SPL 23	P2-H2	26
SPL 10	P1-W3	26	SPL 23	P3-39	22
SPL 10	SPL 9	20	SPL 24	P1-L6	20
SPL 10	P3-2	22	SPL 24	P2-c1	20
SPL 11	P1-M3	20	SPL 24	P2-c2	20
SPL 11	SPL 12	20	SPL 25	P1-L5	20
SPL 12	P1-W2	26	SPL 25	P2-b1	20
SPL 12	SPL 11	20	SPL 25	SPL 26	20
SPL 12	P3-22	22	SPL 26	SPL 25	20
SPL 13	P1-M6	20	SPL 26	P2-b2	20
SPL 13	P1-N5	20	SPL 26	P2-H3	26
SPL 13	P2-K6	26	SPL 26	P3-20	22
SPL 13	P3-14	22	SPL 27	STP5	26
SPL 14	P1-M2	20	SPL 27	P3-27	26
SPL 14	SPL 15	20	SPL 27	P2-M2	26
SPL 15	SPL 14	20	STP1	SPL 5	26
SPL 15	P2-J5	26	STP2	SPL 6	26
SPL 15	P3-35	22	STP3	SPL 5	26
SPL 16	P2-b4	20	STP4	SPL 6	26
SPL 16	SPL 17	20	STP5	SPL 27	26
SPL 17	SPL 16	20	STP6	P1-E6	26
SPL 17	P2-J3	26	STP7	P3-12	26
SPL 17	P3-24	22			







CABLE ASSEMBLY 13083701 WIRE LIST

FROM	TO	WIRE SIZE	FROM	TO	WIRE SIZE	FROM	TO	WIRE SIZE
P1-A1	P3-100	24	P1-Y1	P4-14	24	P2-H2	P5-30	24
P1-D4	P2-E2	24	P1-Y2	P4-15	24	P2-H5	P2-c1	24
P1-H4	P5-31	24	P1-Y3	P4-16	24	P2-H5	P6-H	24
P1-L1	P1-Y6	24	P1-Y4	P4-17	24	P2-H6	P2-b1	24
P1-L1	P4-21	24	P1-Y5	P4-18	24	P2-H6	P6-G	24
P1-L2	P1-W1	24	P1-Y6	P1-L1	24	P2-J2	P4-65	24
P1-L2	P4-22	24	P1-Z1	P4-7	24	P2-J3	P2-N5	24
P1-N1	P3-62	24	P1-Z2	P4-8	24	P2-J4	P4-1	24
P1-N2	P3-63	24	P1-Z3	P4-9	24	P2-J5	P4-4	24
P1-N3	P3-64	24	P1-Z4	P4-10	24	P2-J6	P2-V6	24
P1-N4	P3-65	24	P1-Z5	P4-11	24	P2-J6	P5-28	24
P1-N5	P1-U4	24	P1-Z6	P4-13	24	P2-K1	SPL6	24
P1-N6	P1-U6	24	P1-a1	P3-31	24	P2-K2	P6-U	24
P1-U1	P4-58	24	P1-a2	P3-32	24	P2-K3	SPL5	24
P1-U2	P4-60	24	P1-a3	P3-4	24	P2-K4	P4-74	24
P1-U3	P4-61	24	P1-a4	P3-3	24	P2-K5	P4-70	24
P1-U4	P1-N5	24	P1-a5	P4-5	24	P2-K6	P6-R	24
P1-U4	SPL2	24	P1-a6	P4-6	24	P2-L1	P3-6	24
P1-U5	P4-63	24	P2-A4	P2-S6	24	P2-L2	P3-99	24
P1-U6	P1-N6	24	P2-A6	P3-25	24	P2-L3	STP4	24
P1-U6	SPL1	24	P2-B4	P2-T6	24	P2-L4	SPL3	24
P1-V1	P4-52	24	P2-B6	P3-26	24	P2-L5	SPL4	24
P1-V2	P4-53	24	P2-C4	P3-49	24	P2-L6	P3-16	24
P1-V3	P4-54	24	P2-C6	P3-27	24	P2-M1	P3-72	24
P1-V4	P4-55	24	P2-D4	P3-50	24	P2-M2	P3-2	24
P1-V5	P4-56	24	P2-D6	P2-H1	24	P2-M3	STP5	24
P1-V6	P4-57	24	P2-E2	P1-D4	24	P2-M4	P3-75	24
P1-W1	P1-L2	24	P2-E4	P3-51	24	P2-M5	P3-5	24
P1-W2	P4-35	24	P2-E6	P2-P6	24	P2-M6	P4-73	24
P1-W3	P4-36	24	P2-F4	P3-1	24	P2-N1	P4-66	24
P1-W4	P4-38	24	P2-F6	P2-R6	24	P2-N2	P4-72	24
P1-W5	P4-45	24	P2-G1	P3-98	24	P2-N3	P2-N4	24
P1-W6	P4-51	24	P2-G2	P2-V3	24	P2-N3	P4-2	24
P1-X1	P4-71	24	P2-G4	P5-4	24	P2-N4	P2-N3	24
P1-X2	P4-23	24	P2-G5	P5-25	24	P2-N5	P2-J3	24
P1-X3	P4-24	24	P2-G6	P5-27	24	P2-N5	P4-3	24
P1-X4	P4-25	24	P2-H1	P2-D6	24	P2-N6	P5-11	24
P1-X5	P4-26	24	P2-H1	P2-V5	24	P2-P6	P2-E6	24
P1-X6	P4-27	24	P2-H2	P2-V4	24	P2-R6	P2-F6	24

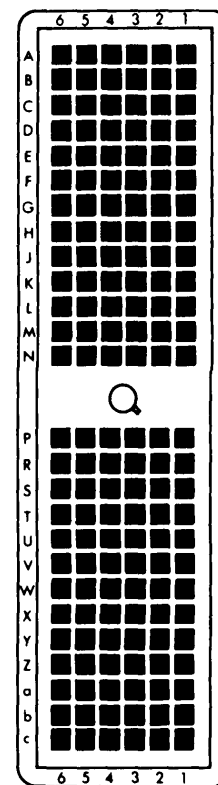

EL9LQ-1000-82A

P1 and P2 - DL1-156P

CABLE ASSEMBLY 13083701 WIRE LIST (cont)

FROM	TO	WIRE SIZE	FROM	TO	WIRE SIZE
P2-S6	P2-A4	24	P3-11	P6-h	24
P2-T6	P2-B4	24	P3-12	P6-g	24
P2-V3	P2-G2	24	P3-13	P2-Y4	24
P2-V4	P2-H2	24	P3-15	P6-C	24
P2-V4	P3-30	24	P3-16	P2-L6	24
P2-V5	P2-H1	24	P3-17	P6-P	24
P2-V5	P3-28	24	P3-18	P6-D	24
P2-V6	P2-J6	24	P3-19	P6-Y	24
P2-V6	P3-29	24	P3-20	P6-X	24
P2-W1	P3-40	24	P3-21	STP4	24
P2-W2	P3-41	24	P3-22	SPL6	24
P2-X1	P4-31	24	P3-23	P6-B	24
P2-X2	P4-48	24	P3-24	P6-A	24
P2-X3	P6-S	24	P3-25	P2-A6	24
P2-X4	P6-W	24	P3-26	P2-B6	24
P2-X5	P6-J	24	P3-27	P2-C6	24
P2-X6	P6-N	24	P3-28	P2-V5	24
P2-Y3	P3-9	24	P3-29	P2-V6	24
P2-Y4	P3-13	24	P3-30	P2-V4	24
P2-Y5	P3-55	24	P3-31	P1-a1	24
P2-Y6	P3-56	24	P3-32	P1-a2	24
P2-Z1	P5-10	24	P3-33	STP6	24
P2-Z2	P6-L	24	P3-34	P2-Z4	24
P2-Z3	P6-M	24	P3-35	P12	24
P2-Z4	P3-34	24	P3-38	P18	24
P2-a1	P3-70	24	P3-40	P2-W1	24
P2-a2	P3-71	24	P3-41	P2-W2	24
P2-b1	P2-H6	24	P3-49	P2-C4	24
P2-c1	P2-H5	24	P3-50	P2-D4	24
P3-1	P2-F4	24	P3-51	P2-E4	24
P3-2	P2-M2	24	P3-55	P2-Y5	24
P3-3	P1-a4	24	P3-56	P2-Y6	24
P3-4	P1-a3	24	P3-62	P1-N1	24
P3-5	P2-M5	24	P3-63	P1-N2	24
P3-6	P2-L1	24	P3-64	P1-N3	24
P3-7	SPL3	24	P3-65	P1-N4	24
P3-8	SPL4	24	P3-66	SPL2	24
P3-9	P2-Y3	24	P3-67	SPL1	24
P3-10	SPL5	24	P3-70	P2-a1	24

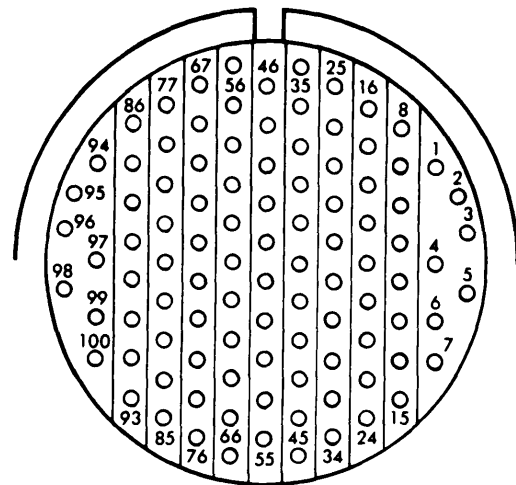

EL9LQ-1000-51

**P3-MS27467T23F35S**

CABLE ASSEMBLY 13083701 WIRE LIST (cont)

FROM	TO	WIRE SIZE	FROM	TO	WIRE SIZE
P3-71	P2-a2	24	P4-51	P1-W6	24
P3-72	P2-M1	24	P4-52	P1-V1	24
P3-73	P17	24	P4-53	P1-V2	24
P3-74	P11	24	P4-54	P1-V3	24
P3-75	P2-M4	24	P4-55	P1-V4	24
P3-98	P2-G1	24	P4-56	P1-V5	24
P3-99	P2-L2	24	P4-57	P1-V6	24
P3-100	P1-A1	24	P4-58	P1-U1	24
P4-1	P2-J4	24	P4-60	P1-U2	24
P4-2	P2-N3	24	P4-61	P1-U3	24
P4-3	P2-N5	24	P4-63	P1-U5	24
P4-4	P2-J5	24	P4-65	P2-J2	24
P4-5	P1-a5	24	P4-66	P2-N1	24
P4-6	P1-a6	24	P4-70	P2-K5	24
P4-7	P1-Z1	24	P4-71	P1-X1	24
P4-8	P1-Z2	24	P4-72	P2-N2	24
P4-9	P1-Z3	24	P4-73	P2-M6	24
P4-10	P1-Z4	24	P4-74	P2-K4	24
P4-11	P1-Z5	24			
P4-13	P1-Z6	24			
P4-14	P1-Y1	24			
P4-15	P1-Y2	24			
P4-16	P1-Y3	24			
P4-17	P1-Y4	24			
P4-18	P1-Y5	24			
P4-21	P1-L1	24			
P4-22	P1-L2	24			
P4-23	P1-X2	24			
P4-24	P1-X3	24			
P4-25	P1-X4	24			
P4-26	P1-X5	24			
P4-27	P1-X6	24			
P4-31	P2-X1	24			
P4-35	P1-W2	24			
P4-36	P1-W3	24			
P4-38	P1-W4	24			
P4-45	P1-W5	24			
P4-48	P2-X2	24			

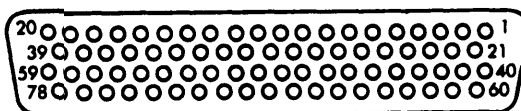

EL9LQ-1000-69

P4 - M24308/2-15F



3-32. TPS CABLE ASSEMBLIES (cont)

3-32

CABLE ASSEMBLY 13083701 WIRE LIST (cont)

FROM	TO	WIRE SIZE	FROM	TO	WIRE SIZE
P5-4	P2-G4	24	P6-d	P6-c	24
P5-6	STP1	24	P6-d	P6-e	24
P5-10	P2-Z1	24	P6-e	P6-d	24
P5-11	P2-N6	24	P6-e	STP12	24
P5-25	P2-G5	24	P6-g	P3-12	24
P5-27	P2-G6	24	P6-g	P9	24
P5-28	P2-J6	24	P6-h	P3-11	24
P5-30	P2-H2	24	P6-h	P13	24
P5-31	P1-H4	24	P6-i	STP8	24
P5-32	P10	24	P6-k	STP7	24
P6-A	P3-24	24	P6-m	P8	24
P6-B	P3-23	24			
P6-C	P3-15	24			
P6-D	P3-18	24			
P6-E	SPL4	24			
P6-F	SPL3	24			
P6-G	P2-H6	24			
P6-H	P2-H5	24			
P6-J	P2-X5	24			
P6-K	P6-b	24			
P6-K	SPL5	24			
P6-L	P2-Z2	24			
P6-M	P2-Z3	24			
P6-N	P2-X6	24			
P6-P	P3-17	24			
P6-R	P2-K6	24			
P6-S	P2-X3	24			
P6-T	P14	24			
P6-U	P2-K2	24			
P6-V	SPL6	24			
P6-W	P2-X4	24			
P6-X	P3-20	24			
P6-Y	P3-19	24			
P6-Z	P15	24			
P6-a	P16	24			
P6-b	P6-K	24			
P6-b	P6-c	24			
P6-c	P6-b	24			

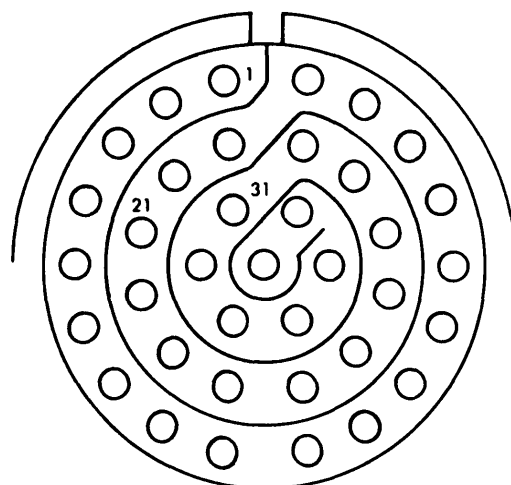

EL9LQ-1000-86

**P5-MS27467T15F35P**

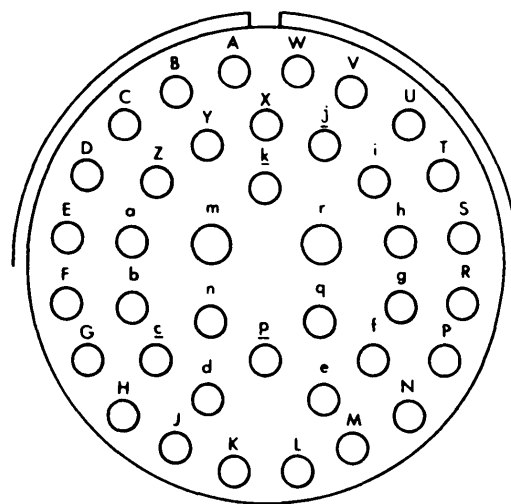

EL9LQ-1000-42A

**P6-MS27467T21F39S**

CABLE ASSEMBLY 13083701 WIRE LIST (cont)

FROM	TO	WIRE SIZE	FROM	TO	WIRE SIZE
P7-E	SPL 2	24	STP6	P3-33	24
P7-F	SPL1	24	STP6	STP5	24
P8	P6-m	24	STP7	P6-k	24
P9	P6-g	24	STP7	STP9	24
P10	P5-32	24	STP8	P6-i	24
P11	P3-74	24	STP9	STP7	24
P12	P3-35	24	STP9	STP10	24
P13	P6-h	24	STP10	STP9	24
P14	P6-T	24	STP11	STP12	24
P15	P6-Z	24	STP12	P6-e	24
P16	P6-a	24	STP12	STP11	24
P17	P3-73	24			
P18	P3-38	24			
SPL 1	P1-U6	24			
SPL 1	P3-67	24			
SPL 1	P7-F	24			
SPL 2	P1-U4	24			
SPL 2	P3-66	24			
SPL 2	P7-E	24			
SPL 3	P2-L 4	24			
SPL 3	P3-7	24			
SPL 3	P6-F	24			
SPL 4	P2-L 5	24			
SPL 4	P3-8	24			
SPL 4	P6-E	24			
SPL 5	P2-K3	24			
SPL 5	P3-10	24			
SPL 5	P6-K	24			
SPL 6	P2-K1	24			
SPL 6	P3-22	24			
SPL 6	P6-V	24			
STP1	P5-6	24			
STP2	STP3	24			
STP3	STP2	24			
STP3	STP4	24			
STP4	P2-L 3	24			
STP4	P3-21	24			
STP4	STP3	24			
STP5	P2-M3	24			
STP5	STP6	24			

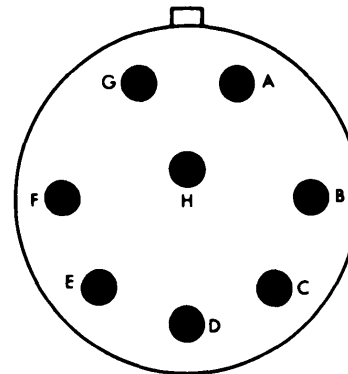

EL9LQ-1000-76

**P7-MS27467T13F8P**





CABLE ASSEMBLY 13083708 WIRE LIST

FROM	TO	WIRE SIZE	FROM	TO	WIRE SIZE
P1-A1	P1-N1	24	P1-T1	P3-C5	24
P1-A3	P1-N3	24	P1-T2	P3-D1	24
P1-A5	P1-M6	24	P1-T3	P3-D3	24
P1-B1	P1-N5	24	P1-T4	P3-D5	24
P1-C1	P1-L1	24	P1-T5	P3-E1	24
P1-C1	P2-26	24	P1-T6	P3-E3	24
P1-C3	P2-22	24	P2-20	P1-D1	24
P1-C5	P2-21	24	P2-21	P1-C5	24
P1-D1	P2-20	24	P2-22	P1-C3	24
P1-D3	P2-30	24	P2-23	P1-K2	24
P1-D5	P2-31	24	P2-24	P1-N5	24
P1-J2	P1-J3	24	P2-25	P1-M6	24
P1-J3	P1-J2	24	P2-26	P1-C1	24
P1-J3	P2-36	24	P2-27	P1-K6	24
P1-J4	P1-J5	24	P2-28	P1-N1	24
P1-J5	P1-J4	24	P2-29	P1-N3	24
P1-J5	P2-37	24	P2-30	P1-D3	24
P1-J6	P2-35	24	P2-31	P1-D5	24
P1-K1	P1-K2	24	P2-32	P1-N4	24
P1-K2	P1-K1	24	P2-33	P1-N2	24
P1-K2	P2-23	24	P2-34	P1-L6	24
P1-K5	P1-K6	24	P2-35	P1-J6	24
P1-K6	P1-K5	24	P2-36	P1-J3	24
P1-K6	P2-27	24	P2-37	P1-J5	24
P1-L1	P1-C1	24	P3-A2	P3-b5	24
P1-L6	P2-34	24	P3-B2	P3-b4	24
P1-M6	P1-A5	24	P3-C5	P1-T1	24
P1-M6	P2-25	24	P3-D1	P1-T2	24
P1-N1	P1-A1	24	P3-D3	P1-T3	24
P1-N1	P2-28	24	P3-D5	P1-T4	24
P1-N2	P2-33	24	P3-E1	P1-T5	24
P1-N3	P1-A3	24	P3-E3	P1-T6	24
P1-N3	P2-29	24	P3-E5	P1-S5	24
P1-N4	P2-32	24	P3-S5	P1-S1	24
P1-N5	P1-B1	24	P3-T1	P1-S2	24
P1-N5	P2-24	24	P3-T3	P1-S3	24
P1-S1	P3-S5	24	P3-b4	P3-B2	24
P1-S2	P3-T1	24	P3-b5	P3-A2	24
P1-S3	P3-T3	24			
P1-S5	P3-E5	24			

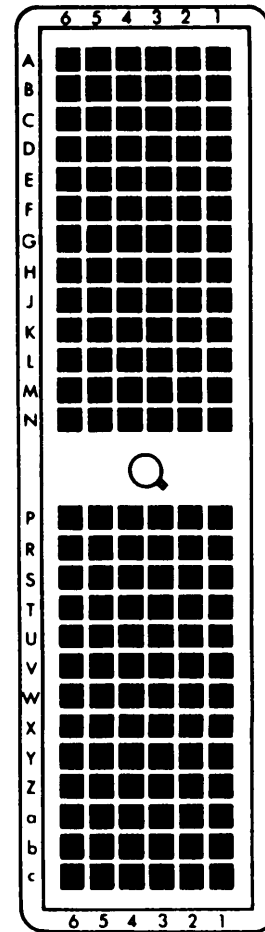

EL9LQ-1000-82A

P1 and P3 - DL1-156P

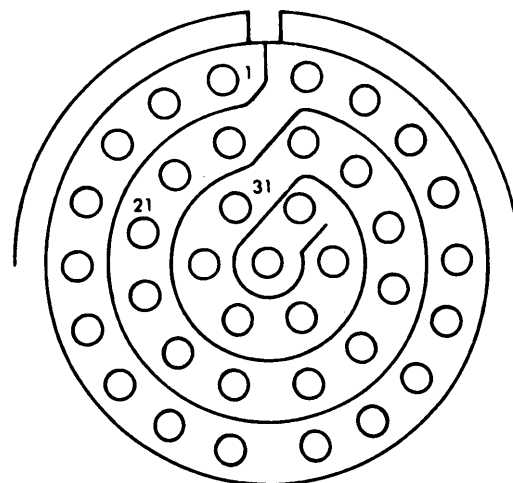

EL9LQ-1000-86

CABLE ASSEMBLY 13083728 WIRE LIST

FROM	TO	WIRE SIZE	FROM	TO	WIRE SIZE
C1-NEG	Q1-C	24	P1-N4	P1-U3	24
C1-POS	TB2-E18	24	P1-U1	P5-P	24
GND	SPL1	22	P1-U2	P5-S	24
P1-E2	SPL1	24	P1-U3	P1-N4	24
P1-E4	SPL1	22	P1-U3	P5-W	24
P1-F2	STP4	24	P1-U4	P5-B	24
P1-H2	P4-3	22	P1-U5	P3-b	24
P1-H3	P4-4	22	P1-U6	TB2-E7	24
P1-H4	P4-5	22	P1-V1	TB2-E2	24
P1-H5	P4-16	22	P1-V2	P1-V4	24
P1-J1	P1-W1	24	P1-V2	P5-R	24
P1-J1	P3-Z	24	P1-V4	P1-V2	24
P1-J2	P5-D	22	P1-V4	P5-j	24
P1-J3	P5-Z	22	P1-V5	TB2-E12	24
P1-J4	P5-A	22	P1-V6	P1-K3	24
P1-J5	P5-X	22	P1-V6	TB2-E5	24
P1-J6	P5-a	24	P1-W1	P1-J1	24
P1-K1	P4-29	24	P1-W4	TB2-E11	24
P1-K2	P4-28	24	P1-W5	P5-G	24
P1-K3	P1-V6	24	P1-W6	P5-H	24
P1-K5	P1-Y1	24	P1-X1	P4-40	24
P1-K6	P3-F	24	P1-X3	P4-17	24
P1-L1	P4-14	22	P1-X4	P5-N	24
P1-L2	P4-15	22	P1-X5	TB2-E8	24
P1-L3	P4-12	22	P1-X6	P4-24	24
P1-L4	P4-13	22	P1-Y1	P1-K5	24
P1-M2	P1-N1	24	P1-Y1	P4-26	24
P1-M3	P1-N2	24	P1-Y3	P4-18	24
P1-M4	P1-N3	24	P1-Y4	P4-35	24
P1-M5	P1-a2	24	P1-Y6	P4-41	24
P1-N1	P1-M2	24	P1-Z2	P4-10	24
P1-N1	P4-8	24	P1-Z4	P4-23	24
P1-N1 SHLD	STP1	SLV	P1-Z5	P5-T	24
P1-N2	P1-M3	24	P1-Z6	P5-L	24
P1-N2	P4-9	24	P1-a1	P3-g	24
P1-N2 SHLD	STP2	SLV	P1-a2	P1-M5	24
P1-N3	P1-M4	24	P1-a2	P4-21	24
P1-N3	P4-22	24	P1-a2 SHLD	STP4	SLV
P1-N3 SHLD	STP3	SLV			

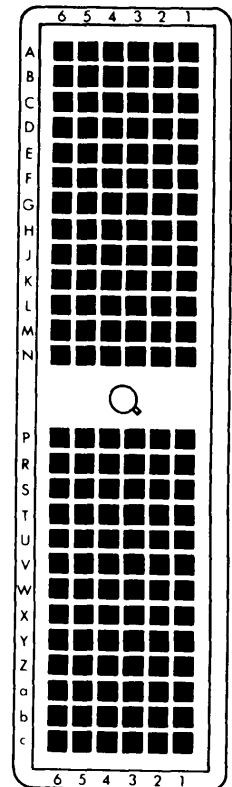

EL9LQ-1000-82A

P1 and P2 - DL1-156P

CABLE ASSEMBLY 13083728 WIRE LIST (cent)

FROM	TO	WIRE SIZE	FROM	TO	WIRE SIZE
P1-a3	P4-34	24	P2-L1	P3-P	24
P1-a4	P4-31	24	P2-L2	P3-R	24
P1-a5	P4-32	24	P2-L3	P3-S	24
P2-A2	P2-b5	24	P2-L4	P3-T	24
P2-A4	P2-E2	24	P2-L5	P3-U	24
P2-A4	P5-U	24	P2-L6	P3-V	24
P2-A6	P5-b	24	P2-M1	P3-G	24
P2-B2	P2-b6	24	P2-M2	P3-H	24
P2-B4	P5-V	24	P2-M3	P3-J	24
P2-B6	P5-c	24	P2-M4	P3-K	24
P2-C4	P5-e	24	P2-M5	P3-X	24
P2-C6	P5-E	24	P2-M6	P3-M	24
P2-D2	P2-a3	24	P2-N1	P3-A	24
P2-D4	P5-h	24	P2-N2	P3-B	24
P2-D6	P5-F	24	P2-N3	P3-C	24
P2-E2	P2-A4	24	P2-N4	P3-D	24
P2-E4	TB2-E1	24	P2-N5	P3-E	24
P2-E6	P4-11	24	P2-N6	P4-6	24
P2-F2	P4-33	24	P2-U2	P4-23	24
P2-F3	P4-34	24	P2-a3	P2-D2	24
P2-F4	P5-J	24	P2-b5	P2-A2	24
P2-F6	P5-M	24	P2-b6	P2-B2	24
P2-G3	P3-N	24	P3-A	P2-N1	24
P2-G4	P4-27	24	P3-B	P2-N2	24
P2-G5	P3-L	24	P3-C	P2-N3	24
P2-G6	P4-1	24	P3-D	P2-N4	24
P2-H1	P3-d	24	P3-E	P2-N5	24
P2-H2	P3-e	24	P3-F	P1-K6	24
P2-H3	P4-37	24	P3-G	P2-M1	24
P2-H4	P4-38	24	P3-H	P2-M2	24
P2-H5	P4-19	24	P3-J	P2-M3	24
P2-H6	P4-33	24	P3-K	P2-M4	24
P2-J3	P3-f	24	P3-L	P2-G5	24
P2-J4	P3-h	24	P3-M	P2-M6	24
P2-J5	P3-a	24	P3-N	P2-G3	24
P2-J6	P4-36	24	P3-P	P2-L1	24
P2-K1	P3-W	24	P3-R	P2-L2	24
P2-K2	P3-Y	24	P3-S	P2-L3	24
P2-K4	P5-C	24			
P2-K6	P3-c	24			

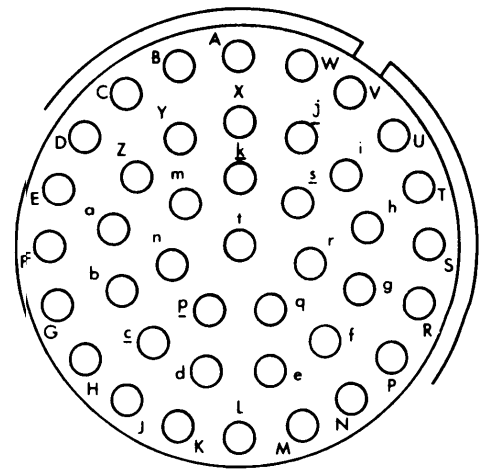

EL9LQ-1000-123

P3-MS3476W20-41PW



3-32. TPS CABLE ASSEMBLIES (cont)

3-32

CABLE ASSEMBLY 13083728 WIRE LIST (cont)

FROM	TO	WIRE SIZE	FROM	TO	WIRE SIZE
P3-T	P2-L4	24	P4-28	P1-K2	24
P3-U	P2-L5	24	P4-29	P1-K1	24
P3-V	P2-L6	24	P4-31	P1-a4	24
P3-W	P2-K1	24	P4-32	P1-a5	24
P3-X	P2-M5	24	P4-33	P2-F2	24
P3-Y	P2-K2	24	P4-33	P2-H6	24
P3-Z	P1-J1	24	P4-34	P1-a3	24
P3-a	P2-J5	24	P4-34	P2-F3	24
P3-b	P1-U5	24	P4-35	P1-Y4	24
P3-c	P2-K6	24	P4-36	P2-J6	24
P3-d	P2-H1	24	P4-37	P2-H3	24
P3-e	P2-H2	24	P4-38	P2-H4	24
P3-f	P2-J3	24	P4-40	P1-X1	24
P3-g	P1-a1	24	P4-41	P1-Y6	24
P3-h	P2-J4	24	P5-A	P1-J4	22
P4-1	P2-G6	24	P5-B	P1-U4	24
P4-3	P1-H2	22	P5-C	P2-K4	24
P4-4	P1-H3	22	P5-D	P1-J2	22
P4-5	P1-H4	22	P5-E	P2-C6	24
P4-6	P2-N6	24	P5-F	P2-D6	24
P4-8	P1-N1	24	P5-G	P1-W5	24
P4-9	P1-N2	24	P5-H	P1-W6	24
P4-10	P1-Z2	24	P5-J	P2-F4	24
P4-11	P2-E6	24	P5-K	TB2-E3	24
P4-12	P1-L3	22	P5-L	P1-Z6	24
P4-13	P1-L4	22	P5-M	P2-F6	24
P4-14	P1-L1	22	P5-N	P1-X4	24
P4-15	P1-L2	22	P5-P	P1-U1	24
P4-16	P1-H5	22	P5-R	P1-V2	24
P4-17	P1-X3	24	P5-R	P5-j	24
P4-18	P1-Y3	24	P5-S	P1-U2	24
P4-19	P2-H5	24	P5-T	P1-Z5	24
P4-21	P1-a2	24	P5-U	P2-A4	24
P4-22	P1-N3	24	P5-V	P2-B4	24
P4-23	P1-Z4	24	P5-W	P1-U3	24
P4-23	P2-U2	24	P5-X	P1-J5	22
P4-24	P1-X6	24	P5-Y	TB2-E14	24
P4-26	P1-Y1	24	P5-Z	P1-J3	22
P4-27	P2-G4	24			

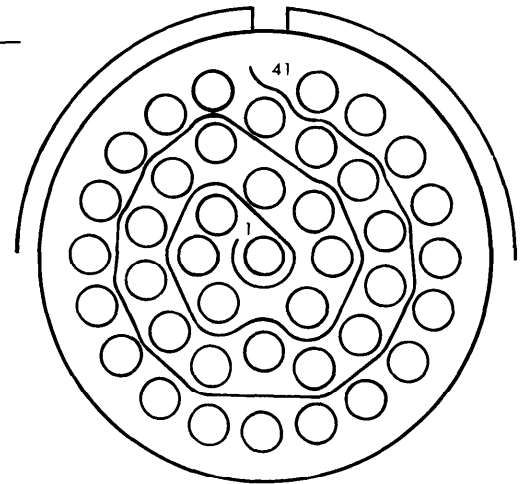

EL9LQ-1000-114A

P4 - M83723-75R20418

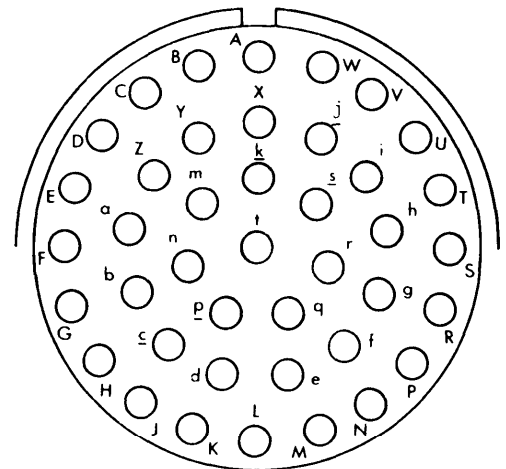

EL9LQ-1000-40A

P5-MS3476W20-41P

## 3-32. TPS CABLE ASSEMBLIES (cont)

3-32

## CABLE ASSEMBLY 13083728 WIRE LIST (cont)

FROM	TO	WIRE SIZE	FROM	TO	WIRE SIZE
P5-a	P1-J6	24	STP3	STP2	24
P5-b	P2-A6	24	STP3	STP4	24
P5-c	P2-B6	24	STP4	P1-F2	24
P5-d	TB2-E4	24	STP4	P1-a2 SHLD	SLV
P5-e	P2-C4	24	STP4	STP3	24
P5-f	TB2-E5	24	STP5	SPL1	SLV
P5-g	TB2-E9	24	STP5	TB2-E18 SHLD	SLV
P5-h	P2-D4	24	TB2-E1	P2-E4	24
P5-i	TB2-E17	24	TB2-E2	P1-V1	24
P5-j	P1-V4	24	TB2-E3	P5-K	24
P5-j	P5-R	24	TB2-E4	P5-d	24
P5-t	TB2-E18	24	TB2-E5	P1-V6	24
Q1-C	C1-NEG	24	TB2-E5	P5-f	24
SPL1	GND	22	TB2-E7	P1-U6	24
SPL1	P1-E2	24	TB2-E8	P1-X5	24
SPL1	P1-E4	22	TB2-E9	P5-g	24
SPL1	STP5	SLV	TB2-E11	P1-W4	24
STP1	P1-N1 SHLD	SLV	TB2-E12	P1-V5	24
STP1	STP2	24	TB2-E14	P5-Y	24
STP2	P1-N2 SHLD	SLV	TB2-E17	P5-i	24
STP2	STP1	24	TB2-E18	C1-POS	24
STP2	STP3	24	TB2-E18	P5-t	24
STP3	P1-N3 SHLD	SLV	TB2-E18 SHLD	STP5	SLV

CABLE ASSEMBLY 13083733 WIRE LIST

FROM	TO	WIRE SIZE	FROM	TO	WIRE SIZE
P1-H2	P1-c4	24	P1-S4	P1-Y1	24
P1-H3	P1-c5	24	P1-S5	P1-V6	24
P1-H4	P1-c6	24	P1-S6	P1-Y4	24
P1-K3	P1-N3	24	P1-T1	P1-Y5	24
P1-K4	P1-L5	24	P1-T2	P1-Y6	24
P1-K6	P2-K2	24	P1-T3	P1-Z1	24
P1-L1	P1-M5	24	P1-T4	P1-a5	24
P1-L2	P1-L4	24	P1-T5	P1-a6	24
P1-L3	P1-W5	24	P1-T6	P1-Z3	24
P1-L4	P1-L2	24	P1-U1	P4-D2	24
P1-L4	P4-D14	24	P1-U2	P4-D3	24
P1-L5	P1-K4	24	P1-U3	P4-D4	24
P1-L5	P4-D9	24	P1-U4	P4-D5	24
P1-L6	P1-M1	24	P1-U5	P4-D6	24
P1-M1	P1-L6	24	P1-U6	P4-D7	24
P1-M1	P4-B7	24	P1-V1	P1-P6	24
P1-M2	P1-M4	24	P1-V1	P4-C12	24
P1-M3	P1-V3	24	P1-V2	P4-C13	24
P1-M4	P1-M2	24	P1-V3	P1-M3	24
P1-M4	P4-A7	24	P1-V3	P4-C14	24
P1-M5	P1-L1	24	P1-V4	P1-N6	24
P1-M5	P4-D1	24	P1-V4	P4-C15	24
P1-M6	P1-V5	24	P1-V5	P1-M6	24
P1-N1	P1-N2	24	P1-V5	P4-C16	24
P1-N2	P4-B12	24	P1-V6	P1-S5	24
P1-N2	P1-N1	24	P1-V6	P1-c2	24
P1-N3	P1-K3	24	P1-W1	P4-C6	24
P1-N3	P4-D13	24	P1-W2	P4-C7	24
P1-N4	P1-N5	24	P1-W3	P4-C8	24
P1-N5	P1-N4	24	P1-W4	P4-C9	24
P1-N5	P4-B5	24	P1-W5	P1-L3	24
P1-N6	P1-V4	24	P1-W5	P4-C10	24
P1-P6	P1-V1	24	P1-W6	P4-C11	24
P1-R1	P2-K3	24	P1-X1	P1-S1	24
P1-R2	P2-J3	24	P1-X1	P4-B16	24
P1-R3	P2-J4	24	P1-X3	P1-c3	24
P1-R4	P2-M4	24	P1-X5	P4-C4	24
P1-R5	P2-A6	24	P1-X6	P4-C5	24
P1-S1	P1-X1	24	P1-Y1	P1-S4	24
P1-S2	P1-Z4	24	P1-Y1	P4-B10	24
P1-S3	P1-a1	24			

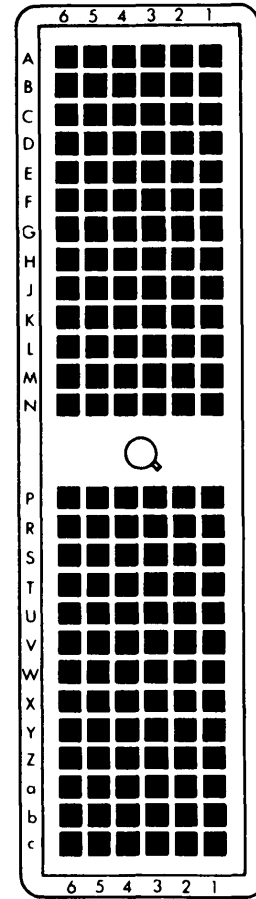

EL9LQ-1000-82A

P1 and P2 - DL1-156P

## CABLE ASSEMBLY 13083733 WIRE LIST (cont)

FROM	TO	WIRE SIZE	FROM	TO	WIRE SIZE
P1-Y2	P4-B11	24	P1-c3	P4-A12	24
P1-Y4	P1-S6	24	P1-c4	P1-H2	24
P1-Y4	P4-B13	24	P1-c5	P1-H3	24
P1-Y5	P1-T1	24	P1-c6	P1-H4	24
P1-Y5	P1-b2	24	P2-A2	P2-N1	24
P1-Y6	P1-T2	24	P2-A4	P4-C3	24
P1-Y6	P4-B15	24	P2-A6	P1-R5	24
P1-Z1	P1-T3	24	P2-A6	P4-A1	24
P1-Z1	P1-b1	24	P2-B2	P2-M3	24
P1-Z2	P4-B4	24	P2-B4	P4-A8	24
P1-Z3	P1-T6	24	P2-B6	P4-A2	24
P1-Z3	P1-b4	24	P2-C2	P2-K4	24
P1-Z4	P1-b5	24	P2-C4	P4-A9	24
P1-Z4	P1-S2	24	P2-C6	P4-A3	24
P1-Z6	P2-E2	24	P2-D2	P2-K5	24
P1-a1	P1-S3	24	P2-D4	P4-A10	24
P1-a1	P1-c1	24	P2-D6	P4-A4	24
P1-a2	P4-A14	24	P2-E2	P1-Z6	24
P1-a3	P4-A15	24	P2-E2	P4-B8	24
P1-a4	P4-A16	24	P2-E4	P4-A11	24
P1-a5	P1-b6	24	P2-E6	P4-A5	24
P1-a5	P1-T4	24	P2-F6	P4-A6	24
P1-a6	P1-T5	24	P2-G4	P4-C2	24
P1-a6	P1-b3	24	P2-G6	P4-C1	24
P1-b1	P1-Z1	24	P2-H1	P3-17	24
P1-b1	P4-B3	24	P2-H2	P3-18	24
P1-b2	P1-Y5	24	P2-J3	P1-R2	24
P1-b2	P4-B14	24	P2-J3	P3-19	24
P1-b3	P1-a6	24	P2-J4	P1-R3	24
P1-b3	P4-B9	24	P2-J4	P3-20	24
P1-b4	P1-Z3	24	P2-J5	P3-23	24
P1-b4	P4-D10	24	P2-J6	P3-24	24
P1-b5	P1-Z4	24	P2-K1	P3-11	24
P1-b5	P4-B6	24	P2-K2	P1-K6	24
P1-b6	P1-a5	24	P2-K2	P3-12	24
P1-b6	P4-B1	24	P2-K3	P1-R1	24
P1-c1	P1-a1	24	P2-K3	P3-13	24
P1-c1	P4-A13	24	P2-K4	P2-C2	24
P1-c2	P1-V6	24	P2-K4	P3-14	24
P1-c2	P4-D12	24	P2-K5	P2-D2	24
P1-c3	P1-X3	24			

CABLE ASSEMBLY 13083733 WIRE LIST (cont)

FROM	TO	WIRE SIZE	FROM	TO	WIRE SIZE
P2-K5	P3-15	24	P4-A1	P2-A6	24
P2-K6	P3-16	24	P4-A2	P2-B6	24
P2-L1	P3-5	24	P4-A3	P2-C6	24
P2-L2	P3-6	24	P4-A4	P2-D6	24
P2-L3	P3-7	24	P4-A5	P2-E6	24
P2-L4	P3-8	24	P4-A6	P2-F6	24
P2-L5	P3-9	24	P4-A7	P1-M4	24
P2-L6	P3-10	24	P4-A8	P2-B4	24
P2-M1	P4-D15	24	P4-A9	P2-C4	24
P2-M2	P4-D16	24	P4-A10	P2-D4	24
P2-M3	P2-B2	24	P4-A11	P2-E4	24
P2-M3	P3-1	24	P4-A12	P1-c3	24
P2-M4	P1-R4	24	P4-A13	P1-c1	24
P2-M4	P3-2	24	P4-A14	P1-a2	24
P2-M6	P3-4	24	P4-A15	P1-a3	24
P2-N1	P2-A2	24	P4-A16	P1-a4	24
P2-N1	P3-3	24	P4-B1	P1-b6	24
P2-N4	P4-B2	24	P4-B2	P2-N4	24
P3-1	P2-M3	24	P4-B3	P1-b1	24
P3-2	P2-M4	24	P4-B4	P1-Z2	24
P3-3	P2-N1	24	P4-B5	P1-N5	24
P3-3	P4-D8	24	P4-B6	P1-b5	24
P3-4	P2-M6	24	P4-B7	P1-M1	24
P3-5	P2-L1	24	P4-B8	P2-E2	24
P3-6	P2-L2	24	P4-B9	P1-b3	24
P3-7	P2-L3	24	P4-B10	P1-Y1	24
P3-8	P2-L4	24	P4-B11	P1-Y2	24
P3-9	P2-L5	24	P4-B12	P1-N2	24
P3-10	P2-L6	24	P4-B13	P1-Y4	24
P3-11	P2-K1	24	P4-B14	P1-b2	24
P3-12	P2-K2	24	P4-B15	P1-Y6	24
P3-13	P2-K3	24	P4-B16	P1-X1	24
P3-14	P2-K4	24	P4-C1	P2-G6	24
P3-15	P2-K5	24	P4-C2	P2-G4	24
P3-16	P2-K6	24	P4-C3	P2-A4	24
P3-17	P2-H1	24	P4-C4	P1-X5	24
P3-18	P2-H2	24	P4-C5	P1-X6	24
P3-19	P2-J3	24	P4-C6	P1-W1	24
P3-20	P2-J4	24	P4-C7	P1-W2	24
P3-23	P2-J5	24	P4-C8	P1-W3	24
P3-24	P2-J6	24			

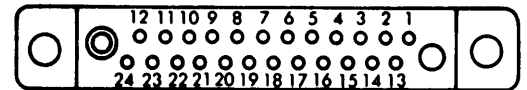

EL9LQ-1000-95

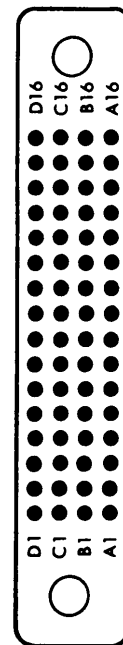

EL9LQ-1000-94A

P4 - MB4-064P-(702)



CABLE ASSEMBLY 13083733 WIRE LIST (cont)

FROM	TO	WIRE SIZE
P4-C9	P1-W4	24
P4-C10	P1-W5	24
P4-C11	P1-W6	24
P4-C12	P1-V1	24
P4-C13	P1-V2	24
P4-C14	P1-V3	24
P4-C15	P1-V4	24
P4-C16	P1-V5	24
P4-D1	P1-M5	24
P4-D2	P1-U1	24
P4-D3	P1-U2	24
P4-D4	P1-U3	24
P4-D5	P1-U4	24
P4-D6	P1-U5	24
P4-D7	P1-U6	24
P4-D8	P3-3	24
P4-D9	P1-L5	24
P4-D10	P1-b4	24
P4-D12	P1-c2	24
P4-D13	P1-N3	24
P4-D14	P1-L4	24
P4-D15	P2-M1	24
P4-D16	P2-M2	24

CABLE ASSEMBLY 13231064 WIRE LIST

FROM	TO	WIRE SIZE
E1	P1	COAX
E2	E3	24



CABLE ASSEMBLY 13231435 WIRE DIAGRAM

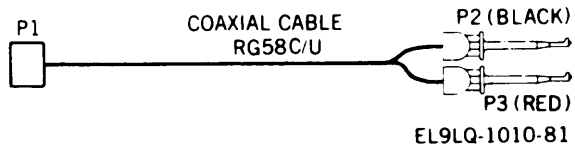

CABLE ASSEMBLY 13231464 WIRE LIST

FROM	TO	WIRE ID	WIRE SIZE	FROM	TO	WIRE ID	WIRE SIZE
GND	P1-U5	114	24	P1-P6	P1-W3	124	26
OPEN	P1 SHLD			P1-R1	P1-Y3	115	26
OPEN	P2 SHLD			P1-R2	P1-Y5	116	26
OPEN	P3 SHLD			P1-R4	P1-X3	118	26
P1 SHLD	OPEN			P1-R5	P2-K3	129	22
P1-E2	SPL5	62	24	P1-R6	P2-K5	132	22
P1-E4	SPL6	63	24	P1-S1	P1-a2	138	26
P1-E6	SPL3	60	24	P1-S2	P1-a1	139	26
P1-F2	SPL4	61	24	P1-S3	P2-N5	120	22
P1-H2	P3-87	55	22	P1-S4	P1-Y1	121	26
P1-H3	P3-4	55	22	P1-S5	P2-K1	149	24
P1-K6	P2-J3	98	24	P1-S6	P1-V2	125	26
P1-L1	P1-V6	131	26	P1-T3	P2-J5	119	22
P1-L2	P1-U6	136	26	P1-T4	P1-U2	126	26
P1-L3	P1-Z1	137	26	P1-T5	P1-Z5	143	26
P1-L4	P1-X1	117	26	P1-T6	P1-Z3	127	26
P1-M1	P2-Y2	123	22	P1-U1	P3-121	12	22
P1-M1	P3-1	11	22	P1-U2	P1-T4	126	26
P1-M2	P2-Y5	128	22	P1-U2	P3-43	16	22
P1-M2	P3-2	15	22	P1-U3	P3-48	56	22
P1-M3	P2-Y6	135	26	P1-U4	P3-71	32	22
P1-M3	P3-21	56	22	P1-U5	GND	114	24
P1-M4	P2-X1	130	22	P1-U6	P1-L2	136	26
P1-M4	P3-31	31	22	P1-U6	P3-7	52	22
P1-M5	P1-N6	140	26	P1-V1	P3-68	53	22
P1-M5	P3-52	57	22	P1-V2	P1-S6	125	26
P1-M6	P2-X5	133	26	P1-V2	P3-42	13	22
P1-M6	P3-50	52	22	P1-V3	P1-b2	148	24
P1-N1	P2-X6	134	26	P1-V4	P1-N5	142	26
P1-N1	P3-37	53	22	P1-V4	P3-61	27	22
P1-N2	P1-Z1	46	24	P1-V5	P3-108	99	24
P1-N2	P3-28	54	22	P1-V6	P1-L1	131	26
P1-N3	P1-Z2	47	24	P1-V6	P3-10	22	22
P1-N3	P3-78	54	22	P1-W1	P1-P5	122	26
P1-N5	P1-V4	142	26	P1-W1	P3-83	9	22
P1-N6	P1-M5	140	26	P1-W2	P3-119	10	22
P1-N6	P2-X2	141	26	P1-W3	P1-P6	124	26
P1-P5	P1-W1	122	26	P1-W3	P3-44	14	22
				P1-W4	P3-16	19	22
				P1-W5	P3-89	20	22
				P1-W6	P3-49	21	22
				P1-X1	P1-L4	117	26

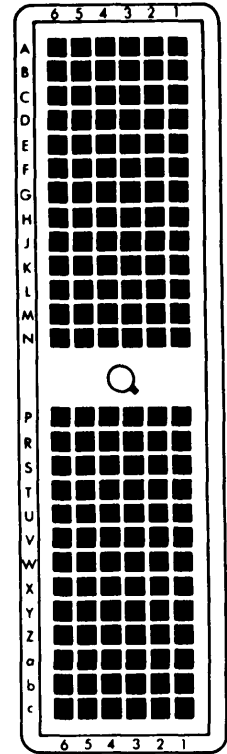

P1 and P2 - DL1-156P

CABLE ASSEMBLY 13231464 WIRE LIST (cont)

FROM	TO	WIRE ID	WIRE SIZE	FROM	TO	WIRE ID	WIRE SIZE
P1-X1	P3-14	3	24	P1-b5	P3-47	49	22
P1-X2	P3-88	3	24	P1-b6	P1-a6	144	26
P1-X3	P1-R4	118	26	P1-b6	P3-13	49	22
P1-X3	P3-33	4	24	P1-c1	P2-H3	147	24
P1-X4	P3-80	4	24	P1-c2	P1-a2	42	24
P1-X5	P3-29	28	22	P1-c2	P3-17	50	22
P1-X6	P3-72	29	22	P1-c3	P1-a3	41	24
P1-Y1	P1-S4	121	26	P1-c3	P3-90	48	22
P1-Y1	P3-27	7	24	P1-c4	P1-Z4	45	24
P1-Y2	P3-38	7	24	P1-c4	P3-40	51	22
P1-Y3	P1-R1	115	26	P1-c5	P2-H5	146	24
P1-Y3	P3-25	1	24	P1-c6	P1-Z6	43	24
P1-Y4	P3-103	1	24	P1-c6	P3-86	50	22
P1-Y5	P1-R2	116	26	P2 SHLD	OPEN		
P1-Y5	P3-19	2	24	P2-A2	P2-S3	150	24
P1-Y6	P3-91	2	24	P2-A2	P3-56	23	22
P1-Z1	P1-L3	137	26	P2-A6	P3-62	76	24
P1-Z1	P1-N2	46	24	P2-B2	P2-R5	110	24
P1-Z2	P1-N3	47	24	P2-B2	P3-96	24	22
P1-Z3	P1-T6	127	26	P2-B6	P3-66	77	24
P1-Z3	P3-23	17	22	P2-C6	P3-107	80	24
P1-Z4	P1-c4	45	24	P2-D2	P2-S1	111	24
P1-Z5	P1-T5	143	26	P2-D2	P3-58	25	22
P1-Z5	P3-12	18	22	P2-E2	P2-S2	112	24
P1-Z6	P1-c6	43	24	P2-E2	P3-94	26	22
P1-a1	P1-S2	139	26	P2-G1	P3-9	107	24
P1-a1	P1-b1	44	24	P2-G2	P3-6	108	24
P1-a2	P1-S1	138	26	P2-G3	P3-26	109	24
P1-a2	P1-c2	42	24	P2-G4	P3-24	103	24
P1-a3	P1-c3	41	24	P2-G5	P3-18	104	24
P1-a4	P1-b4	40	24	P2-G6	P3-15	105	24
P1-a5	P1-b5	38	24	P2-H1	P3-32	106	24
P1-a6	P1-b6	144	26	P2-H2	P3-122	37	26
P1-b1	P1-a1	44	24	P2-H3	P1-c1	147	24
P1-b1	P3-34	51	22	P2-H4	P1-b3	145	24
P1-b2	P1-V3	148	24	P2-H5	P1-c5	146	24
P1-b3	P2-H4	145	24	P2-H6	P3-36	113	26
P1-b4	P1-a4	40	24	P2-J1	P3-98	83	24
P1-b4	P3-22	48	22	P2-J2	P3-60	84	24
P1-b5	P1-a5	38	24	P2-J3	P1-K6	98	24

CABLE ASSEMBLY 13231464 WIRE LIST (cont)

FROM	TO	WIRE ID	WIRE SIZE	FROM	TO	WIRE ID	WIRE SIZE
P2-J3	P3-104	97	24	P2-R4	P3-59	72	24
P2-J4	P3-112	78	24	P2-R5	P2-B2	110	24
P2-J5	P1-T3	119	22	P2-S1	P2-D2	111	24
P2-J5	P3-11	5	24	P2-S2	P2-E2	112	24
P2-J6	P3-92	5	24	P2-S3	P2-A2	150	24
P2-K1	P1-S5	149	24	P2-S4	P3-97	73	24
P2-K1	P3-20	8	24	P2-U2	SPL1	58	24
P2-K2	P3-51	8	24	P2-V2	SPL2	59	24
P2-K3	P1-R5	129	22	P2-X1	P1-M4	130	22
P2-K3	P3-30	30	22	P2-X2	P1-N6	141	26
P2-K4	P3-79	57	22	P2-X3	P3-67	81	24
P2-K5	P1-R6	132	22	P2-X4	P3-105	82	24
P2-K5	P3-35	33	22	P2-X5	P1-M6	133	26
P2-K6	P3-39	34	22	P2-X6	P1-N1	134	26
P2-L1	P3-75	85	24	P2-Y2	P1-M1	123	22
P2-L2	P3-113	86	24	P2-Y3	P3-69	74	24
P2-L3	P3-115	87	24	P2-Y4	P3-106	75	24
P2-L4	P3-111	88	24	P2-Y5	P1-M2	128	22
P2-L5	P3-73	89	24	P2-Y6	P1-M3	135	26
P2-L6	P3-110	90	24	P3 SHLD	OPEN		
P2-M1	P3-65	91	24	P3-1	P1-M1	11	22
P2-M2	P3-99	92	24	P3-2	P1-M2	15	22
P2-M3	P3-100	93	24	P3-3	P3-82	35	26
P2-M4	P3-117	94	24	P3-4	P1-H3	55	22
P2-M5	P3-102	95	24	P3-6	P2-G2	108	24
P2-M6	P3-101	96	24	P3-7	P1-U6	52	22
P2-N1	P3-120	101	24	P3-8	P2-N5	6	24
P2-N2	P3-76	102	24	P3-9	P2-G1	107	24
P2-N3	P3-74	100	24	P3-10	P1-V6	22	22
P2-N4	P3-114	79	24	P3-11	P2-J5	5	24
P2-N5	P1-S3	120	22	P3-12	P1-Z5	18	22
P2-N5	P3-8	6	24	P3-13	P1-b6	49	22
P2-N6	P3-77	6	24	P3-14	P1-X1	3	24
P2-P1	P3-54	64	24	P3-15	P2-G6	105	24
P2-P2	P3-55	65	24	P3-16	P1-W4	19	22
P2-P3	P3-53	66	24	P3-17	P1-c2	50	22
P2-P4	P3-95	67	24	P3-18	P2-G5	104	24
P2-P5	P3-93	68	24	P3-19	P1-Y5	2	24
P2-R1	P3-57	69	24	P3-20	P2-K1	8	24
P2-R2	P3-70	70	24	P3-21	P1-M3	56	22
P2-R3	P3-109	71	24	P3-22	P1-b4	48	22

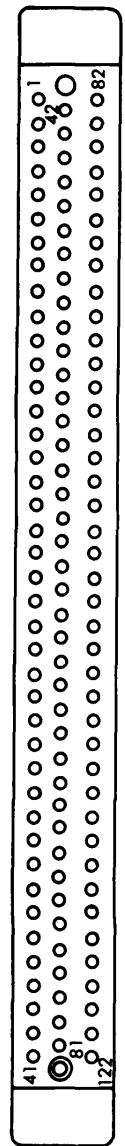

EL9LQ-1000-97

P3-WGA122SAC

## CABLE ASSEMBLY 13231464 WIRE LIST (cont)

FROM	TO	WIRE ID	WIRE SIZE	FROM	TO	WIRE ID	WIRE SIZE
P3-23	P1-Z3	17	22	P3-69	P2-Y3	74	24
P3-24	P2-G4	103	24	P3-70	P2-R2	70	24
P3-25	P1-Y3	1	24	P3-71	P1-U4	32	22
P3-26	P2-G3	109	24	P3-72	P1-X6	29	22
P3-27	P1-Y1	7	24	P3-73	P2-L5	89	24
P3-28	P1-N2	54	22	P3-74	P2-N3	100	24
P3-29	P1-X5	28	22	P3-75	P2-L1	85	24
P3-30	P2-K3	30	22	P3-76	P2-N2	102	24
P3-31	P1-M4	31	22	P3-77	P2-N6	6	24
P3-32	P2-H1	106	24	P3-78	P1-N3	54	22
P3-33	P1-X3	4	24	P3-79	P2-K4	57	22
P3-34	P1-b1	51	22	P3-80	P1-X4	4	24
P3-35	P2-K5	33	22	P3-82	P3-3	35	26
P3-36	P2-H6	113	26	P3-82	P3-122	36	26
P3-37	P1-N1	53	22	P3-83	P1-W1	9	22
P3-38	P1-Y2	7	24	P3-86	P1-c6	50	22
P3-39	P2-K6	34	22	P3-87	P1-H2	55	22
P3-40	P1-c4	51	22	P3-88	P1-X2	3	24
P3-42	P1-V2	13	22	P3-89	P1-W5	20	22
P3-43	P1-U2	16	22	P3-90	P1-c3	48	22
P3-44	P1-W3	14	22	P3-91	P1-Y6	2	24
P3-47	P1-b5	49	22	P3-92	P2-J6	5	24
P3-48	P1-U3	56	22	P3-93	P2-P5	68	24
P3-49	P1-W6	21	22	P3-94	P2-E2	26	22
P3-50	P1-M6	52	22	P3-95	P2-P4	67	24
P3-51	P2-K2	8	24	P3-96	P2-B2	24	22
P3-52	P1-M5	57	22	P3-97	P2-S4	73	24
P3-53	P2-P3	66	24	P3-98	P2-J1	83	24
P3-54	P2-P1	64	24	P3-99	P2-M2	92	24
P3-55	P2-P2	65	24	P3-100	P2-M3	93	24
P3-56	P2-A2	23	22	P3-101	P2-M6	96	24
P3-57	P2-R1	69	24	P3-102	P2-M5	95	24
P3-58	P2-D2	25	22	P3-103	P1-Y4	1	24
P3-59	P2-R4	72	24	P3-104	P2-J3	97	24
P3-60	P2-J2	84	24	P3-105	P2-X4	82	24
P3-61	P1-V4	27	22	P3-106	P2-Y4	75	24
P3-62	P2-A6	76	24	P3-107	P2-C6	80	24
P3-65	P2-M1	91	24	P3-108	P1-V5	99	24
P3-66	P2-B6	77	24	P3-109	P2-R3	71	24
P3-67	P2-X3	81	24	P3-110	P2-L6	90	24
P3-68	P1-V1	53	22	P3-111	P2-L4	88	24

CABLE ASSEMBLY 13231464 WIRE LIST (cont)

FROM	TO	WIRE ID	WIRE SIZE	FROM	TO	WIRE ID	WIRE SIZE
P3-112	P2-J4	78	24	SPL5	P1-E2	62	24
P3-113	P2-L2	86	24	SPL5	STP12		
P3-114	P2-N4	79	24	SPL5	STP13		
P3-115	P2-L3	87	24	SPL5	STP16		
P3-117	P2-M4	94	24	SPL5	STP21		
P3-119	P1-W2	10	22	SPL5	STP22		
P3-120	P2-N1	101	24	SPL5	STP27		
P3-121	P1-U1	12	22	SPL5	STP32		
P3-122	P2-H2	37	26	SPL6	P1-E4	63	24
P3-122	P3-82	36	26	SPL6	STP11		
SPL1	P2-U2	58	24	SPL6	STP15		
SPL1	STP5			SPL6	STP31		
SPL1	STP6			SPL6	STP38		
SPL1	STP8			SPL6	STP39		
SPL1	STP30			SPL6	STP40		
SPL1	STP33			SPL6	STP41		
SPL1	STP34			STP1	SPL3		
SPL2	P2-V2	59	24	STP2	SPL3		
SPL2	STP23			STP3	SPL3		
SPL2	STP24			STP4	SPL3		
SPL2	STP25			STP5	SPL1		
SPL2	STP26			STP6	SPL1		
SPL2	STP35			STP7	SPL3		
SPL2	STP36			STP8	SPL1		
SPL2	STP37			STP9	SPL4		
SPL3	P1-E6	60	24	STP10	SPL4		
SPL3	STP1			STP11	SPL6		
SPL3	STP2			STP12	SPL5		
SPL3	STP3			STP13	SPL5		
SPL3	STP4			STP14	SPL4		
SPL3	STP7			STP15	SPL6		
SPL3	STP17			STP16	SPL5		
SPL3	STP18			STP17	SPL3		
SPL4	P1 SHLD			STP18	SPL3		
SPL4	P1-F2	61	24	STP19	SPL4		
SPL4	STP9			STP20	SPL4		
SPL4	STP10			STP21	SPL5		
SPL4	STP14			STP22	SPL5		
SPL4	STP19			STP23	SPL2		
SPL4	STP20			STP24	SPL2		
SPL4	STP28			STP25	SPL2		
SPL4	STP29						





---

3-32. TPS CABLE ASSEMBLIES (cont)3-32

---

CABLE ASSEMBLY 13231464 WIRE LIST (cont)

---

FROM	TO	WIRE ID	WIRE SIZE
------	----	------------	--------------

---

STP26	SPL2		
STP27	SPL5		
STP28	SPL4		
STP29	SPL4		
STP30	SPL1		
STP31	SPL6		
STP32	SPL5		
STP33	SPL1		
STP34	SPL1		
STP35	SPL2		
STP36	SPL2		
STP37	SPL2		
STP38	SPL6		
STP39	SPL6		
STP40	SPL6		
STP41	SPL6		

---

CABLE ASSEMBLY 13231470 WIRE LIST

FROM	TO	WIRE ID	WIRE SIZE	FROM	TO	WIRE ID	WIRE SIZE
P1-A1	SPL2	1	24	P2-J1	P5-5	47	24
P1-A2	SPL3	3	24	P2-J2	SPL20	48	24
P1-A3	SPL4	5	24	P2-J3	SPL72	183	24
P1-A4	PI-X1	7	24	P2-J4	SPL73	185	24
P1-A5	SPL5	8	24	P2-J5	SPL22	250	24
P1-B1	P1-X2	10	24	P2-J6	SPL23	251	24
P1-B2	SPL6	11	24	P2-K1	SPL13	34	24
P1-B3	SPL7	13	24	P2-K2	SPL12	29	24
P1-B4	SPL8	15	24	P2-K3	P6-e	55	24
P1-B5	SPL9	17	24	P2-K4	SPL11	27	24
P1-B6	SPL10	19	24	P2-K5	SPL24	252	24
P1-J1	SPL2	230	24	P2-K6	SPL25	253	24
P1-J2	SPL3	231	24	P2-L1	SPL26	254	24
P1-J3	SPL4	232	24	P2-L2	SPL28	256	24
P1-J4	SPL9	237	24	P2-L3	SPL29	257	24
P1-J5	SPL10	238	24	P2-L4	SPL30	258	24
P1-W1	P6-Z	21	24	P2-L5	SPL31	259	24
P1-W2	SPL5	233	24	P2-L6	P5-1	31	24
P1-W3	P6-C	22	24	P2-L6	SPL1	45	24
P1-W4	SPL6	234	24	P2-M1	P6-k	70	24
P1-X1	P1-A4	7	24	P2-M2	SPL32	71	24
P1-X2	P1-B1	10	24	P2-M3	SPL33	74	24
P2-A2	P6-b	23	24	P2-M4	SPL34	262	24
P2-A4	P4-107	24	24	P2-M5	SPL35	263	24
P2-A5	SPL69	158	24	P2-M6	SPL27	255	24
P2-A6	P6-g	25	24	P2-N1	SPL36	264	24
P2-B2	SPL11	26	24	P2-N2	SPL37	265	24
P2-B4	SPL12	28	24	P2-N3	SPL38	266	24
P2-B6	P5-1	30	24	P2-N4	SPL39	267	24
P2-B6	SPL1	44	24	P2-N5	SPL8	16	24
P2-C2	P6-L	32	24	P2-N6	SPL7	14	24
P2-C4	SPL13	33	24	P2-P5	SPL40	268	24
P2-C6	P6-u	35	24	P2-P5	P4-93	87	24
P2-D2	P6-X	36	24	P2-P6	SPL41	269	24
P2-D4	P6-v	37	24	P2-R1	SPL42	270	24
P2-D6	P6-p	38	24	P2-R2	SPL43	271	24
P2-F2	SPL14	242	24	P2-R3	SPL44	272	24
P2-F5	SPL14	39	24	P2-R4	SPL45	273	24
P2-H2	SPL15	243	24	P2-R5	SPL46	274	24
P2-H3	SPL16	223	24	P2-R6	SPL47	275	24
P2-H4	SPL17	227	24	P2-S1	SPL48	276	24
P2-H5	SPL18	225	24	P2-S2	SPL49	277	24
P2-H6	SPL19	229	24	P2-S3	SPL50	278	24

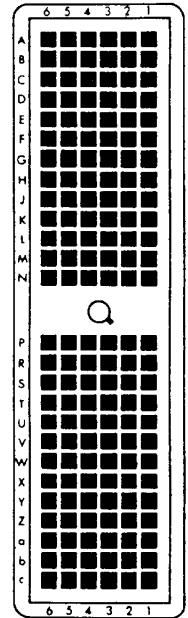

EL9LG-1000-82A

P1, P2, and P3-DL1-156

## 3-32. TPS CABLE ASSEMBLIES (cont)

3-32

## CABLE ASSEMBLY 13231470 WIRE LIST

FROM	TO	WIRE ID	WIRE SIZE	FROM	TO	WIRE ID	WIRE SIZE
P2-S4	SPL51	279	24	P2-a1	SPL22	51	24
P2-S5	SPL52	280	24	P2-a2	SPL23	53	24
P2-S6	SPL53	281	24	P2-a3	SPL36	78	24
P2-T1	SPL54	282	24	P2-a4	SPL37	80	24
P2-T2	SPL55	283	24	P2-a6	SPL68	156	24
P2-T3	SPL56	284	24	P2-b1	P6-N	159	24
P2-T4	SPL57	285	24	P2-b2	SPL21	249	24
P2-T5	SPL58	286	24	P2-b3	P6-f	160	24
P2-T6	SPL59	287	24	P2-b4	P6-R	161	24
P2-U1	P4-115	118	24	P2-b5	SPL68	296	24
P2-U2	P4-3	119	24	P2-b6	SPL69	297	24
P2-U3	SPL56	112	24	P2-c5	SPL70	298	24
P2-U4	SPL57	114	24	P2-c6	SPL71	299	24
P2-U5	P4-27	121	24	P3-A2	SPL60	288	24
P2-U6	P4-38	122	24	P3-A4	P4-36	167	24
P2-V1	P4-56	123	24	P3-A6	SPL70	162	24
P2-V2	P4-69	124	24	P3-B2	SPL74	302	24
P2-V3	P4-35	125	24	P3-B4	P5-84	174	24
P2-V4	P4-9	126	24	P3-B6	SPL71	164	24
P2-V5	SPL24	56	24	P3-C2	SPL75	303	24
P2-V6	SPL25	58	24	P3-C4	P4-120	171	24
P2-W1	SPL60	127	24	P3-C6	P5-13	172	24
P2-W2	SPL61	129	24	P3-D2	SPL61	289	24
P2-W3	SPL62	131	24	P3-D4	P5-8	173	24
P2-W4	SPL15	41	24	P3-D6	P5-22	175	24
P2-W5	SPL30	66	24	P3-E2	SPL62	290	24
P2-W6	SPL31	68	24	P3-E4	P4-15	176	24
P2-X1	SPL63	136	24	P3-E6	P4-122	178	24
P2-X2	P3-S6	138	24	P3-F4	P4-16	176	24
P2-X3	P3-T6	139	24	P3-F6	P4-17	167	24
P2-X4	P6-U	140	24	P3-G2	SPL34	75	24
P2-Y1	SPL33	73	24	P3-G3	SPL35	77	24
P2-Y2	SPL20	248	24	P3-G4	SPL27	62	24
P2-Y3	SPL32	72	24	P3-G5	SPL26	60	24
P2-Y5	SPL64	144	24	P3-H1	P4-127	179	24
P2-Y6	SPL65	146	24	P3-H2	SPL28	63	24
P2-Z1	SPL66	148	24	P3-H3	SPL29	65	24
P2-Z2	SPL67	150	24	P3-H4	SPL72	182	24
P2-Z3	P6-G	152	24	P3-H5	SPL73	184	24
P2-Z4	P6-S	153	24	P3-J1	SPL44	92	24
P2-Z5	P4-72	154	24	P3-J2	SPL45	94	24
P2-Z6	P4-94	155	24	P3-J3	SPL52	106	24

Change 18 3-560.9

CABLE ASSEMBLY 13231470 WIRE LIST

WIRE FROM	WIRE TO	ID	SIZE	FROM	TO	WIRE ID	WIRE SIZE
P3-J4	SPL53	108	24	P3-Y2	P5-48	208	24
P3-J5	SPL74	168	24	P3-Y3	P5-49	209	24
P3-J6	SPL75	170	24	P3-Y4	P5-59	210	24
P3-K1	SPL40	86	24	P3-Y5	P5-61	211	24
P3-K2	SPL41	88	24	P3-Y6	P5-71	212	24
P3-K3	SPL46	95	24	P3-Z1	P6-m	213	24
P3-K4	SPL47	97	24	P3-Z2	P5-9	214	24
P3-K5	SPL42	89	24	P3-Z3	P5-17	215	24
P3-K6	SPL43	91	24	P3-Z4	P5-26	216	24
P3-L1	P5-37	186	24	P3-Z5	P5-27	217	24
P3-L2	P5-25	187	24	P3-Z6	P5-36	218	24
P3-L3	P4-125	188	24	P3-a1	P5-55	219	24
P3-L4	P4-110	188	24	P3-a2	P5-47	220	24
P3-L5	P4-111	189	24	P3-b4	SPL66	294	24
P3-L6	P4-61	189	24	P3-b5	SPL67	295	24
P3-M1	SPL39	84	24	P4-1	SPL53	107	24
P3-M2	SPL38	82	24	P4-3	P2-U2	119	24
P3-M3	SPL48	98	24	P4-9	P2-V4	126	24
P3-M4	SPL49	100	24	P4-10	SPL28	64	24
P3-M5	SPL54	109	24				
P3-M6	SPL55	111	24				
P3-N1	SPL58	115	24				
P3-N2	SPL59	117	24				
P3-N5	SPL50	102	24				
P3-N6	SPL51	105	24				
P3-S2	P5-6	191	24				
P3-S6	P2-X2	138	24				
P3-T6	P2-X3	139	24				
P3-V4	SPL64	292	24				
P3-V5	SPL65	293	24				
P3-V6	SPL63	291	24				
P3-W1	P5-116	196	24				
P3-W2	P5-122	197	24				
P3-W3	P5-124	198	24				
P3-W4	P5-125	199	24				
P3-W5	P6-J	200	24				
P3-X1	P5-83	201	24				
P3-X2	P5-94	202	24				
P3-X3	P5-95	203	24				
P3-X4	P5-96	204	24				
P3-X5	P5-106	205	24				
P3-X6	P5-115	206	24				
P3-Y1	P5-38	207	24				

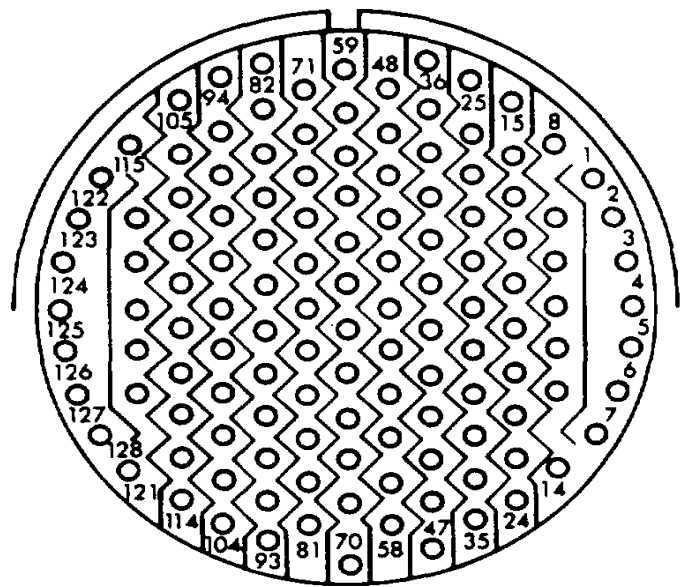

EL9LQ-1000-2

P4-MS27467T25F35S

CABLE ASSEMBLY 13231470 WIRE LIST

FROM	TO	WIRE ID	WIRE SIZE	FROM	TO	WIRE ID	WIRE SIZE
P4-11	SPL29	64	24	P4-125	P3-L3	188	24
P4-14	SPL45	93	24	P4-127	P3-H1	179	24
P4-15	P3-E4	176	24	P5-1	SPL1	43	24
P4-16	P3-F4	176	24	P5-2	SPL2	2	24
P4-17	P3-F6	167	24	P5-5	P2-J1	47	24
P4-24	SPL42	90	24	P5-6	P3-S2	191	24
P4-27	P2-U5	121	24	P5-8	P3-D4	173	24
P4-35	P2-V3	125	24	P5-9	P3-Z2	214	24
P4-36	P3-A4	167	24	P5-13	P3-C6	172	24
P4-37	SPL52	107	24	P5-14	SPL57	113	24
P4-38	P2-U6	122	24	P5-17	P3-Z3	215	24
P4-47	SPL43	90	24	P5-22	P3-D6	175	24
P4-50	SPL44	93	24	P5-25	P3-L2	187	24
P4-56	P2-V1	123	24	P5-26	P3-Z4	216	24
P4-61	P3-L6	189	24	P5-27	P3-Z5	217	24
P4-69	P2-V2	124	24	P5-33	SPL56	113	24
P4-72	P2-Z5	154	24				
P4-81	SPL49	101	24				
P4-82	SPL35	76	24				
P4-83	SPL54	110	24				
P4-92	SPL48	99	24				
P4-93	SPL40	87	24				
P4-94	P2-Z6	155	24				
P4-95	SPL59	116	24				
P4-96	SPL68	157	24				
P4-102	SPL50	103	24				
P4-103	SPL51	104	24				
P4-104	SPL46	96	24				
P4-105	SPL58	116	24				
P4-106	SPL27	61	24				
P4-107	P2-A4	24	24				
P4-109	SPL55	110	24				
P4-110	P3-L4	188	24				
P4-111	P3-L5	189	24				
P4-114	SPL41	87	24				
P4-115	P2-U1	118	24				
P4-116	SPL69	157	24				
P4-117	SPL34	76	24				
P4-120	P3-C4	171	24				
P4-121	SPL47	96	24				
P4-122	P3-E6	178	24				
P4-123	SPL26	61	24				

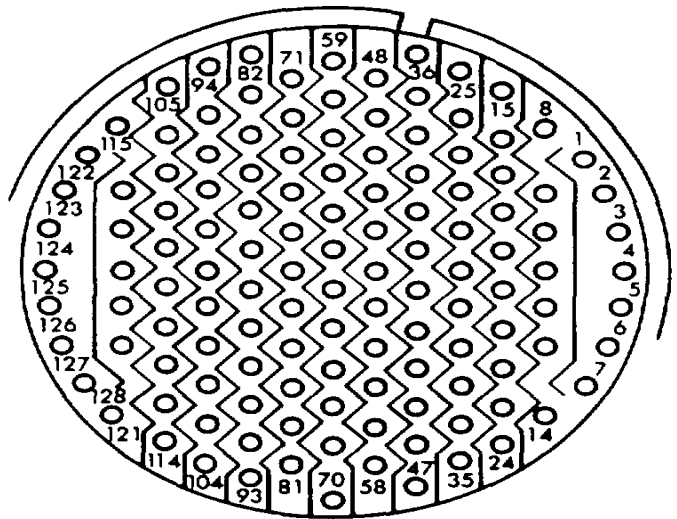

EL9LQ-1000-124

P5-MS27467T25F35SA

CABLE ASSEMBLY 13231470 WIRE LIST

FROM	TO	WIRE ID	WIRE SIZE	FROM	TO	WIRE ID	WIRE SIZE
P5-34	SPL15	42	24	P6-DD	SPL67	151	24
P5-35	SPL60	128	24	P6-EE	SPL16	244	24
P5-36	P3-Z6	218	24	P6-FF	SPL72	300	24
P5-37	P3-L1	186	24	P6-G	P2-Z3	152	24
P5-38	P3-Y1	207	24	P6-H	SPL37	81	24
P5-47	P3-a2	220	24	P6-J	P3-W5	200	24
P5-48	P3-Y2	208	24	P6-JJ	SPL18	246	24
P5-49	P3-Y3	209	24	P6-K	SPL13	241	24
P5-55	P3-a1	219	24	P6-L	P2-C2	32	24
P5-57	SPL25	59	24	P6-LL	SPL17	245	24
P5-59	P3-Y4	210	24	P6-M	SPL11	239	24
P5-61	P3-Y5	211	24	P6-N	P2-b1	159	24
P5-68	SPL61	130	24	P6-P	SPL21	50	24
P5-69	SPL24	57	24	P6-R	P2-b4	161	24
P5-70	SPL62	132	24	P6-S	P2-Z4	153	24
P5-71	P3-Y6	212	24				
P5-73	SPL74	169	24				
P5-82	SPL75	169	24				
P5-83	P3-X1	201	24				
P5-84	P3-B4	174	24				
P5-93	SPL70	163	24				
P5-94	P3-X2	202	24				
P5-95	P3-X3	203	24				
P5-96	P3-X4	204	24				
P5-103	SPL31	69	24				
P5-104	SPL71	165	24				
P5-105	SPL22	52	24				
P5-106	P3-X5	205	24				
P5-107	SPL38	83	24				
P5-113	SPL30	67	24				
P5-115	P3-X6	206	24				
P5-116	P3-W1	196	24				
P5-117	SPL39	85	24				
P5-122	P3-W2	197	24				
P5-123	SPL36	79	24				
P5-124	P3-W3	198	24				
P5-125	P3-W4	199	24				
P6-A	SPL32	260	24				
P6-AA	SPL66	149	24				
P6-B	SPL14	40	24				
P6-C	P1-W3	22	24				
P6-D	SPL33	261	24				
P6-D	P2-Y1	73	24				

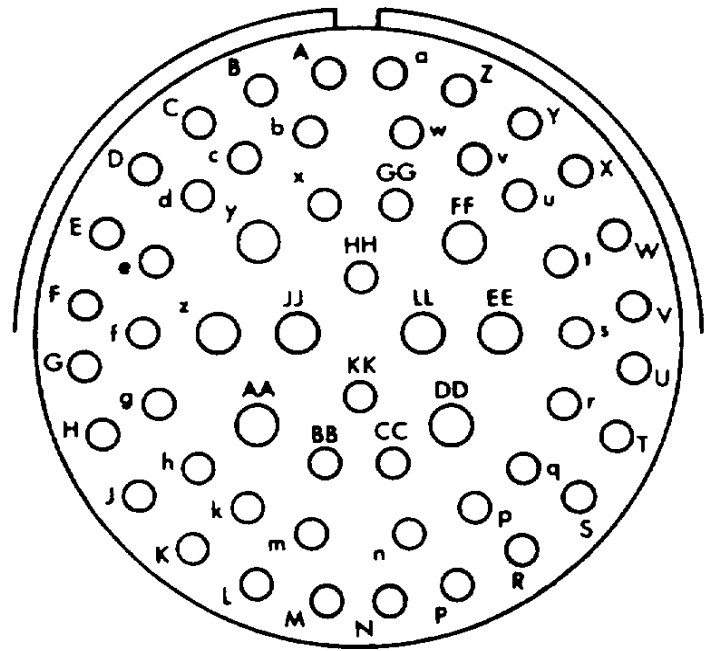

EL9LQ-1000-96

P6-MS2746725F4S

## 3-32. TPS CABLE ASSEMBLIES (cont)

3-32

## CABLE ASSEMBLY 13231470 WIRE LIST

FROM	TO	WIRE ID	WIRE SIZE	FROM	TO	WIRE ID	WIRE SIZE
P6-T	SPL3	4	24	SPL5	P1-A5	8	24
P6-U	P2-X4	140	24	SPL5	P6-Y	9	24
P6-V	SPL65	147	24	SPL5	P1-W2	233	24
P6-W	SPL64	145	24	SPL6	P1-W4	234	24
P6-X	P2-D2	36	24	SPL6	P1-B2	11	24
P6-Y	SPL5	9	24	SPL6	P6-n	12	24
P6-Z	P1-W1	21	24	SPL7	P6-c	235	24
P6-a	SPL8	236	24	SPL7	P1-B3	13	24
P6-b	P2-A2	23	24	SPL7	P2-N6	14	24
P6-c	SPL7	235	24	SPL8	P6-a	236	24
P6-e	P2-K3	55	24	SPL8	P1-B4	15	24
P6-f	P2-b3	160	24	SPL8	P2-N5	16	24
P6-g	P2-A6	25	24	SPL9	P1-J4	237	24
P6-h	SPL23	54	24	SPL9	P1-B5	17	24
P6-k	P2-M1	70	24	SPL9	P6-s	18	24
P6-m	P3-Z1	213	24	SPL10	P1-J5	238	24
P6-n	SPL6	12	24	SPL10	P1-B6	19	24
P6-p	P2-D6	38	24	SPL10	P6-r	20	24
P6-q	SPL12	240	24	SPL11	P6-M	239	24
P6-r	SPL10	20	24	SPL11	P2-B2	26	24
P6-s	SPL9	18	24	SPL11	P2-K4	27	24
P6-t	SPL63	137	24	SPL12	P6-q	240	24
P6-u	P2-C6	35	24	SPL12	P2-B4	28	24
P6-v	P2-D4	37	24	SPL12	P2-K2	29	24
P6-w	SPL4	6	24	SPL13	P6-K	241	24
P6-y	SPL73	301	24	SPL13	P2-C4	33	24
P6-z	SPL19	247	24	SPL13	P2-K1	34	24
P7-A	SPL16	222	24	SPL14	P2-F2	242	24
P7-E	SPL17	226	24	SPL14	P2-F5	39	24
P7-J	SPL18	224	24	SPL14	P6-B	40	24
P7-N	SPL19	228	24	SPL15	P2-H2	243	24
SPL1	P5-1	43	24	SPL15	P2-W4	41	24
SPL1	P2-B6	44	24	SPL15	P5-34	42	24
SPL1	P2-L6	45	24	SPL16	P6-EE	244	24
SPL2	P5-2	2	24	SPL16	P7-A	222	24
SPL2	P1-J1	230	24	SPL16	P2-H3	223	24
SPL2	P1-A1	1	24	SPL17	P6-LL	245	24
SPL3	P1-J2	231	24	SPL17	P7-E	226	24
SPL3	P1-A2	3	24	SPL17	P2-H4	227	24
SPL3	P6-T	4	24	SPL18	P6-JJ	246	24
SPL4	P1-J3	232	24	SPL18	P7-J	224	24
SPL4	P1-A3	5	24	SPL18	P2-H5	225	24
SPL4	P6-w	6	24	SPL19	P6-z	247	24

Change 18 3-560.13



## CABLE ASSEMBLY 13231470 WIRE LIST

FROM	TO	WIRE ID	WIRE SIZE	FROM	TO	WIRE ID	WIRE SIZE
SPL19	P7-N	228	24	SPL33	P2-M3	74	24
SPL19	P2-H6	229	24	SPL34	P2-M4	262	24
SPL20	P2-Y2	248	24	SPL34	P3-G2	75	24
SPL20	P2-J2	48	24	SPL34	P4-117	76	24
SPL20	SPL21	49	24	SPL35	P2-M5	263	24
SPL21	P2-b2	249	24	SPL35	P4-82	76	24
SPL21	SPL20	49	24	SPL35	P3-G3	77	24
SPL21	P6-P	50	24	SPL36	P2-N1	264	24
SPL22	P2-J5	250	24	SPL36	P2-a3.	78	24
SPL22	P2-a1	51	24	SPL36	P5-123	79	24
SPL22	P5-105	52	24	SPL37	P2-N2	265	24
SPL23	P2-J6	251	24	SPL37	P2-a4	80	24
SPL23	P2-a2	53	24	SPL37	P6-H	81	24
SPL23	P6-h	54	24	SPL38	P2-N3	266	24
SPL24	P2-K5	252	24	SPL38	P3-M2	82	24
SPL24	P2-V5	56	24	SPL38	P5-107	83	24
SPL24	P5-69	57	24	SPL39	P2-N4	267	24
SPL25	P2-K6	253	24	SPL39	P3-M1	84	24
SPL25	P2-V6	58	24	SPL39	P5-117	85	24
SPL25	P5-57	59	24	SPL40	P2-P5	268	24
SPL26	P2-L1	254	24	SPL40	P3-K1	86	24
SPL26	P3-G5	60	24	SPL40	P4-93	87	24
SPL26	P4-123	61	24	SPL41	P2-P6	269	24
SPL27	P2-M6	255	24	SPL41	P4-114	87	24
SPL27	P4-106	61	24	SPL41	P3-K2	88	24
SPL27	P3-G4	62	24	SPL42	P2-R1	270	24
SPL28	P2-L2	256	24	SPL42	P3-K5	89	24
SPL28	P3-H2	63	24	SPL42	P4-24	90	24
SPL28	P4-10	64	24	SPL43	P2-R2	271	24
SPL29	P2-L3	257	24	SPL43	P4-47	90	24
SPL29	P4-11	64	24	SPL43	P3-K6	91	24
SPL29	P3-H3	65	24	SPL44	P2-R3	272	24
SPL30	P2-L4	258	24	SPL44	P3-J1	92	24
SPL30	P2-W5	66	24	SPL44	P4-50	93	24
SPL30	P5-113	67	24	SPL45	P2-R4	273	24
SPL31	P2-L5	259	24	SPL45	P4-14	93	24
SPL31	P2-W6	68	24	SPL45	P3-J2	94	24
SPL31	P5-103	69	24	SPL46	P2-R5	274	24
SPL32	P6-A	260	24	SPL46	P3-K3	95	24
SPL32	P2-M2	71	24	SPL46	P4-104	96	24
SPL32	P2-Y3	72	24	SPL47	P2-R6	275	24
SPL33	P6-D	261	24	SPL47	P4-121	96	24
SPL33	P2-Y1	73	24	SPL47	P3-K4	97	24

## 3-32. TPS CABLE ASSEMBLIES (cont)

3-32

## CABLE ASSEMBLY 13231470 WIRE LIST

FROM	TO	WIRE ID	WIRE SIZE	FROM	TO	WIRE ID	WIRE SIZE
SPL48	P2-S1	276	24	SPL62	P2-W3	131	24
SPL48	P3-M3	98	24	SPL62	P5-70	132	24
SPL48	P4-92	99	24	SPL63	P3-V6	291	24
SPL49	P2-S2	277	24	SPL63	P2-X1	136	24
SPL49	P3-M4	100	24	SPL63	P6-t	137	24
SPL49	P4-81	101	24	SPL64	P3-V4	292	24
SPL50	P2-S3	278	24	SPL64	P2-Y5	144	24
SPL50	P3-N5	102	24	SPL64	P6-W	145	24
SPL50	P4-102	103	24	SPL65	P3-V5	293	24
SPL51	P2-S4	279	24	SPL65	P2-Y6	146	24
SPL51	P4-103	104	24	SPL65	P6-V	147	24
SPL51	P3-N6	105	24	SPL66	P3-B4	294	24
SPL52	P2-S5	280	24	SPL66	P2-Z1	148	24
SPL53	P3-J4	108	24	SPL66	P6-AA	149	24
SPL54	P2-T1	282	24	SPL67	P3-b5	295	24
SPL54	P3-M5	109	24	SPL67	P2-Z2	150	24
SPL54	P4-83	110	24	SPL67	P6-DD	151	24
SPL52	P3-J3	106	24	SPL68	P2-b5	296	24
SPL52	P4-37	107	24	SPL68	P2-a6	156	24
SPL53	P2-S6	281	24	SPL68	P4-96	157	24
SPL53	P4-1	107	24	SPL69	P2-b6	297	24
SPL55	P2-T2	283	24	SPL69	P4-116	157	24
SPL55	P4-109	110	24	SPL69	P2-A5	158	24
SPL55	P3-M6	111	24	SPL70	P2-c5	298	24
SPL56	P2-T3	284	24	SPL70	P3-A6	162	24
SPL56	P2-U3	112	24	SPL70	P5-93	163	24
SPL56	P5-33	113	24	SPL71	P2-c6	299	24
SPL57	P2-T4	285	24	SPL71	P3-B6	164	24
SPL57	P5-14	113	24	SPL71	P5-104	165	24
SPL57	P2-U4	114	24	SPL72	P6-FF	300	24
SPL58	P2-T5	286	24	SPL72	P3-H4	182	24
SPL58	P3-N1	115	24	SPL72	P2-J3	183	24
SPL58	P4-105	116	24	SPL73	P6-y	301	24
SPL59	P2-T6	287	24	SPL73	P3-H5	184	24
SPL59	P4-95	116	24	SPL73	P2-J4	185	24
SPL59	P3-N2	117	24	SPL74	P3-B2	302	24
SPL60	P3-A2	288	24	SPL74	P3-J5	168	24
SPL60	P2-W1	127	24	SPL74	P5-73	169	24
SPL60	P5-35	128	24	SPL75	P3-C2	303	24
SPL61	P3-D2	289	24	SPL75	P5-82	169	24
SPL61	P2-W2	129	24	SPL75	P3-J6	170	24
SPL61	P5-68	130	24				
SPL62	P3-E2	290	24				

\*U GOVERNMENT PRINTING OFFICE: 1996 - 775-025/40263

Change 18 3-560.14.1/(3-560.14.2 blank)

CABLE ASSEMBLY 13231473 WIRE LIST

FROM	TO	WIRE ID	WIRE SIZE	FROM	TO	WIRE ID	WIRE SIZE
P1-A1	P1-N1	37	24				
P1-B1	P1-N4	39	24				
P1-B3	SPL11	22	24				
P1-B5	P2-4	26	24				
P1-C1	P1-L1	27	24				
P1-C1	P2-8	28	24				
P1-C3	P1-L4	29	24				
P1-C5	P2-5	25	24				
P1-D5	SPL9	17	24				
P1-H2	SPL7	14	24				
P1-H3	SPL3	6	24				
P1-J1	P3-N	35	24				
P1-J2	P3-P	32	24				
P1-L1	P1-C1	27	24				
P1-L2	SPL1	1	24				
P1-L3	SPL1	2	24				
P1-L4	P1-C3	29	24				
P1-L4	P1-L5	30	24				
P1-L5	P1-L4	30	24				
P1-L5	P2-9	31	24				
P1-M1	SPL5	10	24				
P1-M2	SPL5	9	24				
P1-M5	P3-A	33	24				
P1-M6	P3-B	34	24				
P1-N1	P1-A1	37	24				
P1-N1	P2-6	36	24				
P1-N2	SPL2	4	24				
P1-N3	SPL6	12	24				
P1-N4	P1-B1	39	24				
P1-N4	P2-7	38	24				
P1-N5	SPL10	20	24				
P1-N6	SPL9	18	24				
P2-1	SPL4	8	20				
P2-2	SPL8	16	20				
P2-3	SPL12	24	20				
P2-4	P1-B5	26	24				
P2-5	P1-C5	25	24				
P2-6	P1-N1	36	24				
P2-7	P1-N4	38	24				
P2-8	P1-C1	28	24				
P2-9	P1-L5	31	24				

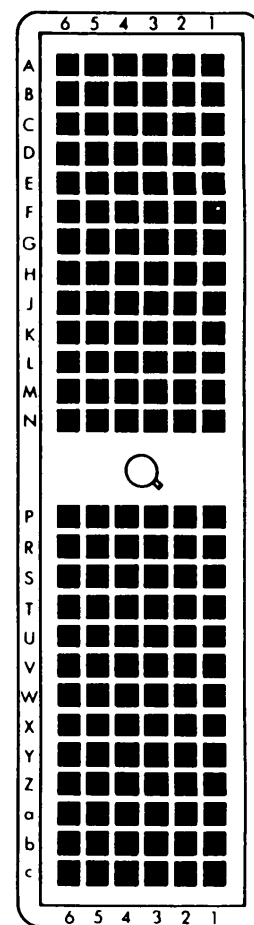

EL9LQ-1000-82A

P1-DL1-156P

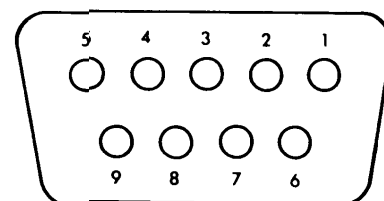

EL9LQ-1000-10

P2-M24308/2-1F

CABLE ASSEMBLY 13231473 WIRE LIST (cont)

FROM	TO	WIRE ID	WIRE SIZE	FROM	TO	WIRE ID	WIRE SIZE
P3-A	P1-M5	33	24				
P3-B	P1-M6	34	24				
P3-N	P1-J1	35	24				
P3-P	P1-J2	32	24				
SPL 1	P1-L2	1	24				
SPL 1	P1-L3	2	24				
SPL 1	SPL 2	3	24				
SPL 2	P1-N2	4	24				
SPL 2	SPL 1	3	24				
SPL 2	SPL 3	5	24				
SPL 3	P1-H3	6	24				
SPL 3	SPL 2	5	24				
SPL 3	SPL 4	7	16				
SPL 4	P2-1	8	20				
SPL 4	SPL 3	7	16				
SPL 5	P1-M1	10	24				
SPL 5	P1-M2	9	24				
SPL 5	SPL 6	11	24				
SPL 6	P1-N3	12	24				
SPL 6	SPL 5	11	24				
SPL 6	SPL 7	13	24				
SPL 7	P1-H2	14	24				
SPL 7	SPL 6	13	24				
SPL 7	SPL 8	15	16				
SPL 8	P2-2	16	20				
SPL 8	SPL 7	15	16				
SPL 9	P1-D5	17	24				
SPL 9	P1-N6	18	24				
SPL 9	SPL 10	19	24				
SPL 10	P1-N5	20	24				
SPL 10	SPL 11	21	24				
SPL 10	SPL 9	19	24				
SPL 11	P1-B3	22	24				
SPL 11	SPL 10	21	24				
SPL 11	SPL 12	23	16				
SPL 12	P2-3	24	20				
SPL 12	SPL 11	23	16				

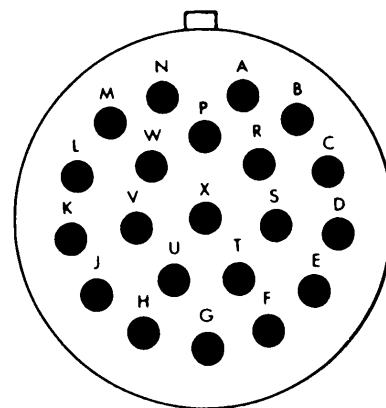

EL9LQ-1000-90

PT06SE-22-21P (SR) 

CABLE ASSEMBLY 13231512 WIRE LIST

FROM	TO	WIRE ID	WIRE SIZE	FROM	TO	WIRE ID	WIRE SIZE
P1-A1	P3-1	1	24	P1-N5	SPL 28	52	24
P1-A2	SPL 14	270	24	P1-N6	P1-M1	37	24
P1-A3	P1-K4	2	24	P1-N6	P2-a1	38	24
P1-A4	SPL 15	272	24	P1-R1	P3-71	146	24
P1-A5	P1-V2	4	24	P1-R5	P2-J4	65	24
P1-B4	SPL 8	260	24	P1-R6	P2-J1	67	24
P1-B6	SPL 12	266	24	P1-S3	P3-83	147	24
P1-C2	SPL 13	268	24	P1-S4	P3-102	148	24
P1-E2	P2-b2	7	24	P1-S5	P3-112	149	24
P1-E4	P8-J	251	20	P1-S6	P3-111	150	24
P1-F3	P3-12	152	24	P1-T1	P5-64	80	24
P1-F5	P3-25	151	24	P1-T2	P3-13	81	24
P1-H2	SPL 8	8	24	P1-T3	P3-24	82	24
P1-H5	SPL 12	11	24	P1-T4	P3-14	83	24
P1-H6	P3-73	12	24	P1-T5	P3-19	84	24
P1-J1	SPL 13	13	24	P1-U1	P3-120	87	24
P1-J2	SPL 21	100	24	P1-U2	P5-27	88	24
P1-J3	SPL 14	15	24	P1-U3	P3-62	89	24
P1-J4	SPL 15	16	24	P1-U4	P3-110	90	24
P1-K1	P1-K2	19	24	P1-U5	P5-76	92	24
P1-K2	P1-K1	19	24	P1-U6	P5-65	91	24
P1-K2	P2-Z3	20	24	P1-V1	P3-20	86	24
P1-K3	P1-W1	22	24	P1-V2	P1-A5	4	24
P1-K4	P1-A3	2	24	P1-V2	P2-F3	5	24
P1-K4	P3-90	3	24	P1-V3	P3-101	93	24
P1-L1	P2-U2	26	24	P1-V4	P7-C4	236	24
P1-L2	P2-U4	28	24	P1-V5	P7-C6	238	24
P1-L3	P2-G3	30	24	P1-V6	P3-119	96	24
P1-L4	P2-G4	32	24	P1-W1	P1-K3	22	24
P1-L5	P1-L6	34	24	P1-W1	P3-17	23	24
P1-L6	P1-L5	34	24	P1-W2	P3-43	97	24
P1-L6	P2-Z2	35	24	P1-W3	P4-n	98	24
P1-M1	P1-N6	37	24	P1-W4	P4-C	99	24
P1-M2	P1-M3	40	24	P1-W5	P3-84	85	24
P1-M3	M1-M2	40	24	P1-W6	P3-22	71	24
P1-M3	P2-a2	41	24	P1-X1	P4-h	101	24
P1-M4	SPL 25	43	24	P1-X2	P3-94	102	24
P1-M5	SPL 26	46	24	P1-X3	P3-50	103	24
P1-M6	SPL 27	49	24	P1-X4	P3-74	104	24
P1-N2	P2-c5	55	24	P1-X5	P3-85	105	24
P1-N3	P2-c4	56	24	P1-X6	P3-28	106	24

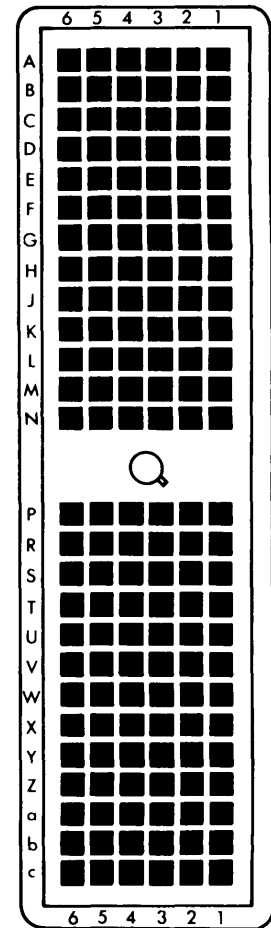

EL9LQ-1000-82A

P1 - DL1-156P

CABLE ASSEMBLY 13231512 WIRE LIST (cont)

FROM	TO	WIRE ID	WIRE SIZE	FROM	TO	WIRE ID	WIRE SIZE
P1-Y1	P3-16	107	24	P2-D6	P3-56	161	24
P1-Y2	P3-26	108	24	P2-E2	P3-98	187	24
P1-Y3	P3-36	109	24	P2-E4	P3-96	162	24
P1-Y4	P3-87	110	24	P2-E6	P3-37	163	24
P1-Y5	P4-v	111	24	P2-F2	P1-Z2	114	24
P1-Y6	P4-w	112	24	P2-F2	P4-X	115	24
P1-Z1	P4-t	113	24	P2-F3	P1-V2	5	24
P1-Z2	P2-F2	114	24	P2-F3	P3-108	6	24
P1-Z3	P3-59	116	24	P2-F4	P3-15	164	24
P1-Z4	P3-34	117	24	P2-F6	P3-11	165	24
P1-Z5	P3-88	118	24	P2-G1	SPL 26	47	24
P1-Z6	P3-23	119	24	P2-G2	SPL 27	50	24
P1-a1	P1-b3	120	24	P2-G3	P1-L 3	30	24
P1-a2	SPL 7	253	24	P2-G3	P3-52	31	24
P1-a3	P4-U	121	24	P2-G4	P1-L 4	32	24
P1-a4	P4-V	122	24	P2-G4	P3-41	3	24
P1-a5	P4-W	123	24	P2-G5	SPL 11	231	24
P1-a6	P4-s	124	24	P2-G6	P3-76	166	24
P1-b1	P2-W1	125	24	P2-H1	P3-65	167	24
P1-b2	P2-W2	127	24	P2-H2	P3-53	168	24
P1-b3	P1-a1	120	24	P2-H3	P3-46	69	24
P1-b4	SPL 22	129	24	P2-H4	P3-58	70	24
P1-b5	P2-X2	131	24	P2-H5	SPL 28	53	24
P1-b5	P3-93	61	24	P2-H6	SPL 25	44	24
P1-b6	P2-X3	133	24	P2-J1	P1-R6	67	24
P1-c1	P2-S1	252	24	P2-J1	P3-103	68	24
P1-c2	P2-X4	135	24	P2-J2	P2-c1	169	24
P1-c3	P2-X5	137	24	P2-J3	P3-81	172	24
P1-c4	SPL 23	139	24	P2-J4	P1-R5	65	24
P1-c5	P2-W4	141	24	P2-J4	P3-92	66	24
P1-c6	SPL 24	143	24	P2-J5	P3-113	173	24
P2-A2	P3-86	153	24	P2-J6	P3-32	174	24
P2-A4	P4-u	154	24	P2-K1	P4-P	175	24
P2-A6	P3-63	155	24	P2-K2	P4-R	176	24
P2-B4	P3-10	156	24	P2-K3	P4-S	177	24
P2-B6	P3-75	157	24	P2-K4	P4-T	178	24
P2-C2	SPL 22	130	24	P2-K5	P3-68	179	24
P2-C4	P3-99	158	24	P2-K6	P3-79	180	24
P2-C6	P3-38	159	24	P2-L1	P2-S2	240	24
P2-D2	P3-39	186	24	P2-L2	P2-S3	241	24
P2-D4	P3-95	160	24	P2-L3	P2-S4	242	24

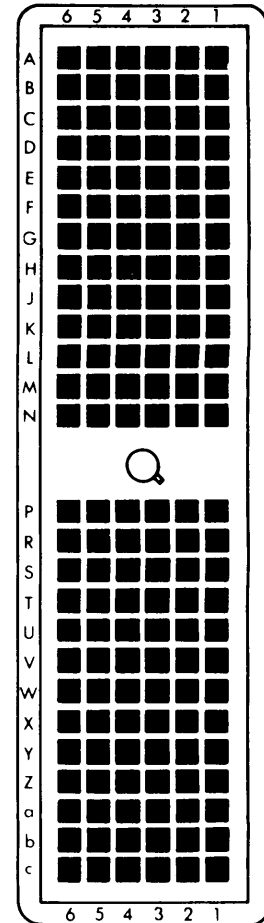

EL9LG-1000-82A

P2-DL1-156P

## 3-32. TPS CABLE ASSEMBLIES (cont)

3-32

## CABLE ASSEMBLY 13231512 WIRE LIST (cont)

FROM	TO	WIRE ID	WIRE SIZE	FROM	TO	WIRE ID	WIRE SIZE
P2-L4	P3-45	181	24	P2-V6	P3-21	183	24
P2-L5	P2-T2	243	24	P2-W1	P1-b1	125	24
P2-L6	SPL19	280	24	P2-W1	P4-k	126	24
P2-M1	P2-P1	244	24	P2-W2	P1-b2	127	24
P2-M2	P2-P2	245	24	P2-W2	P4-m	128	24
P2-M3	P3-107	60	24	P2-W3	SPL24	144	24
P2-M4	P3-118	62	24	P2-W4	P1-c5	141	24
P2-M5	P3-116	64	24	P2-W4	P4-G	142	24
P2-M6	P3-100	188	24	P2-W5	SPL23	140	24
P2-N1	P5-26	189	24	P2-X1	P3-72	59	24
P2-N2	P7-G2	57	24	P2-X2	P1-b5	131	24
P2-N3	P3-33	72	24	P2-X2	P4-q	132	24
P2-N4	P3-57	190	24	P2-X3	P1-b6	133	24
P2-N5	P7-G3	58	24	P2-X3	P4-r	134	24
P2-N6	SPL22	284	18	P2-X4	P1-c2	135	24
P2-P1	P2-M1	244	24	P2-X4	P4-A	136	24
P2-P2	P2-M2	245	24	P2-X5	P1-c3	137	24
P2-P3	P3-69	73	24	P2-X5	P4-B	138	24
P2-P4	P3-91	74	24	P2-X6	P5-24	192	24
P2-P5	P3-80	75	24	P2-Y6	P3-82	63	24
P2-P6	P4-E	191	24	P2-Z1	P2-b6	196	24
P2-R1	P3-117	76	24	P2-Z2	P1-L6	35	24
P2-R2	P3-106	77	24	P2-Z2	P4-L	36	24
P2-R3	SPL7	254	24	P2-Z3	P1-K2	20	24
P2-R4	SPL19	78	24	P2-Z3	P4-M	21	24
P2-R5	P4-Y	79	24	P2-Z4	P2-a3	193	24
P2-S1	P1-c1	252	24	P2-a1	P1-N6	38	24
P2-S1	P8-F	233	20	P2-a1	P4-H	39	24
P2-S2	P2-L1	240	24	P2-a2	P1-M3	41	24
P2-S3	P2-L2	241	24	P2-a2	P4-J	42	24
P2-S4	P2-L3	242	24	P2-a3	P2-Z4	193	24
P2-S6	P2-U6	184	24	P2-a3	P2-b4	194	24
P2-T2	P2-L5	243	24	P2-a4	P2-U4	29	24
P2-T6	P3-44	182	24	P2-a5	P2-U2	27	24
P2-U2	P1-L1	26	24	P2-b1	P2-V2	185	24
P2-U2	P2-a5	27	24	P2-b2	P1-E2	7	24
P2-U4	P1-L2	28	24	P2-b4	P2-a3	194	24
P2-U4	P1-a4	29	24	P2-b4	P4-N	195	24
P2-U6	P2-S6	184	24	P2-b5	P2-b6	197	24
P2-V2	P2-b1	185	24	P2-b5	P4-K	198	24
P2-V4	SPL11	230	24				

3-32. TPS CABLE ASSEMBLIES (cont)

CABLE ASSEMBLY 13231512 WIRE LIST (cont)

FROM	TO	WIRE ID	WIRE SIZE
P2-b6	P2-Z1	196	24
P2-b6	P2-b5	197	24
P2-c1	P2-J2	169	24
P2-c1	P2-c2	170	24
P2-c2	P2-c1	170	24
P2-c2	P3-109	171	24
P2-c4	P1-N3	56	24
P2-c5	P1-N2	55	24
P3-1	P1-A1	1	24
P3-8	SPL21	282	24
P3-9	SPL11	229	24
P3-10	P2-B4	156	24
P3-11	P2-F6	165	24
P3-12	P1-F3	152	24
P3-13	P1-T2	81	24
P3-14	P1-T4	83	24
P3-15	P2-F4	164	24
P3-16	P1-Y1	107	24
P3-17	P1-W1	23	24
P3-18	SPL20	281	24
P3-19	P1-T5	84	24
P3-20	P1-V1	86	24
P3-21	P2-V6	183	24
P3-22	P1-W6	71	24
P3-23	P1-Z6	119	24
P3-24	P1-T3	82	24
P3-25	P1-F5	151	24
P3-26	P1-Y2	108	24
P3-28	P1-X6	106	24
P3-29	SPL8	259	24
P3-30	SPL16	273	24
P3-31	SPL17	275	24
P3-32	P2-J6	174	24
P3-33	P2-N3	72	24
P3-34	P1-Z4	117	24
P3-35	P8-D	234	24
P3-36	P1-Y3	109	24
P3-37	P2-E6	163	24
P3-38	P2-C6	159	24
P3-39	P2-D2	186	24
P3-40	SPL12	265	24
P3-41	P2-G4	33	24
P3-42	SPL25	45	24

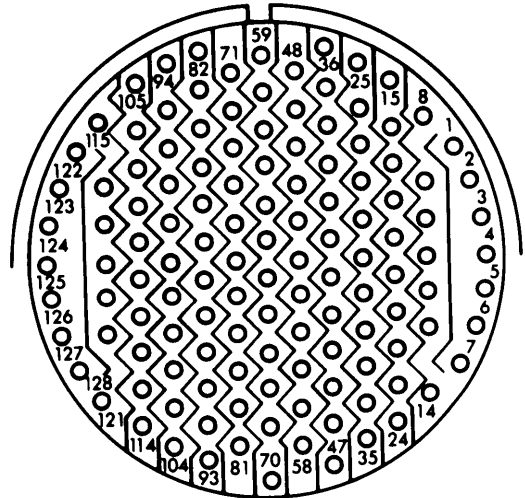

EL9LQ-1000-2

P3-MS27467T25F35S



## 3-32. TPS CABLE ASSEMBLIES (cont)

3-32

## CABLE ASSEMBLY 13231512 WIRE LIST (cont)

FROM	TO	WIRE ID	WIRE SIZE
P3-43	P1-W2	97	24
P3-44	P2-T6	182	24
P3-45	P2-L4	181	24
P3-46	P2-H3	69	24
P3-47	P8-E	235	24
P3-50	P1-X3	103	24
P3-51	SPL18	277	24
P3-52	P2-G3	31	24
P3-53	P2-H2	168	24
P3-54	SPL28	54	24
P3-56	P2-D6	161	24
P3-57	P2-N4	190	24
P3-58	P2-H4	70	24
P3-59	P1-Z3	116	24
P3-61	SPL15	271	24
P3-62	P1-U3	89	24
P3-63	P2-A6	155	24
P3-64	SPL13	267	24
P3-65	P2-H1	167	24
P3-66	SPL26	48	24
P3-68	P2-K5	179	24
P3-69	P2-P3	73	24
P3-71	P1-R1	146	24
P3-72	P2-X1	59	24
P3-73	P1-H6	12	24
P3-74	P1-X4	104	24
P3-75	P2-B6	157	24
P3-76	P2-G6	166	24
P3-77	SPL27	51	24
P3-78	SPL9	261	24
P3-79	P2-K6	180	24
P3-80	P2-P5	75	24
P3-81	P2-J3	172	24
P3-82	P2-Y6	63	24
P3-83	P1-S3	147	24
P3-84	P1-W5	85	24
P3-85	P1-X5	105	24
P3-86	P2-A2	153	24
P3-87	P1-Y4	110	24
P3-88	P1-Z5	118	24
P3-89	SPL10	263	24

CABLE ASSEMBLY 13231512 WIRE LIST (cont)

FROM	TO	WIRE ID	WIRE SIZE
P3-90	P1-K4	3	24
P3-91	P2-P4	74	24
P3-92	P2-J4	66	24
P3-93	P1-b5	61	24
P3-94	P1-X2	102	24
P3-95	P2-D4	160	24
P3-96	P2-E4	162	24
P3-97	SPL 14	269	24
P3-98	P2-E2	187	24
P3-99	P2-C4	158	24
P3-100	P2-M6	188	24
P3-101	P1-V3	93	24
P3-102	P1-S4	148	24
P3-103	P2-J1	68	24
P3-106	P2-R2	77	24
P3-107	P2-M3	60	24
P3-108	P2-F3	6	24
P3-109	P2-c2	171	24
P3-110	P1-U4	90	24
P3-111	P1-S6	150	24
P3-112	P1-S5	149	24
P3-113	P2-J5	173	24
P3-116	P2-M5	64	24
P3-117	P2-R1	76	24
P3-118	P2-M4	62	24
P3-119	P1-V6	96	24
P3-120	P1-U1	87	24
P4-A	P2-X4	136	24
P4-B	P2-X5	138	24
P4-C	P1-W4	99	24
P4-D	SPL 24	287	20
P4-E	P2-P6	191	24
P4-F	SPL 23	286	20
P4-G	P2-W4	142	24
P4-H	P2-a1	39	24
P4-J	P2-a2	42	24
P4-K	P2-b5	198	24
P4-L	P2-Z2	36	24
P4-M	P2-Z3	21	24
P4-N	P2-b4	195	24
P4-P	P2-K1	175	24

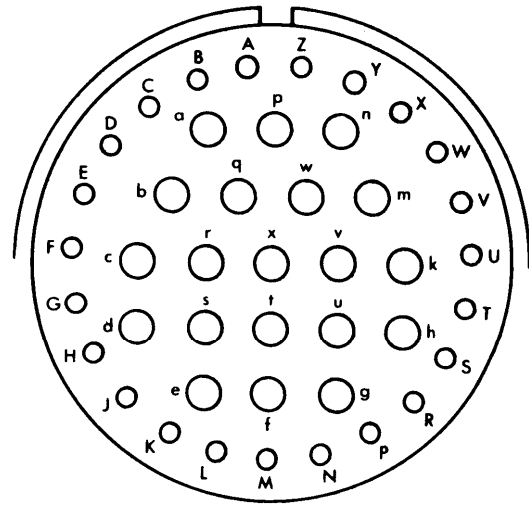

EL9LQ-1000-73

P4-MS24767T25F43S

ABLE ASSEMBLY 13231512 WIRE LIST (cont)

FROM	TO	WIRE ID	WIRE SIZE
P4-R	P2-K2	176	24
P4-S	P2-K3	177	24
P4-T	P2-K4	178	24
P4-U	P1-a3	121	24
P4-V	P1-a4	122	24
P4-W	P1-a5	123	24
P4-X	P2-F2	115	24
P4-Y	P2-R5	79	24
P4-a	SPL 1	201	18
P4-b	SPL 3	211	18
P4-c	SPL 5	220	18
P4-d	SPL 2	208	18
P4-e	SPL 4	217	18
P4-f	SPL 6	226	18
P4-g	SPL 7	255	18
P4-h	P1-X1	101	24
P4-k	P2-W1	126	24
P4-m	P2-W2	128	24
P4-n	P1-W3	98	24
P4-p	SPL 22	285	18
P4-q	P2-X2	132	24
P4-r	P2-X3	134	24
P4-s	P1-a6	124	24
P4-t	P1-Z1	113	24
P4-u	P2-A4	154	24
P4-v	P1-Y5	111	24
P4-w	P1-Y6	112	24
P4-x	SPL 19	279	18
P5-24	P2-X6	192	24
P5-26	P2-N1	189	24
P5-27	P1-U2	88	24
P5-64	P1-T1	80	24
P5-65	P1-U6	92	24
P5-76	P1-U5	91	24
P6-A	SPL 1	202	
P6-B	SPL 1	203	
P6-E	SPL 3	212	
P6-F	SPL 3	213	
P6-J	SPL 5	221	
P6-K	SPL 5	222	
P6-N	SPL 7	256	

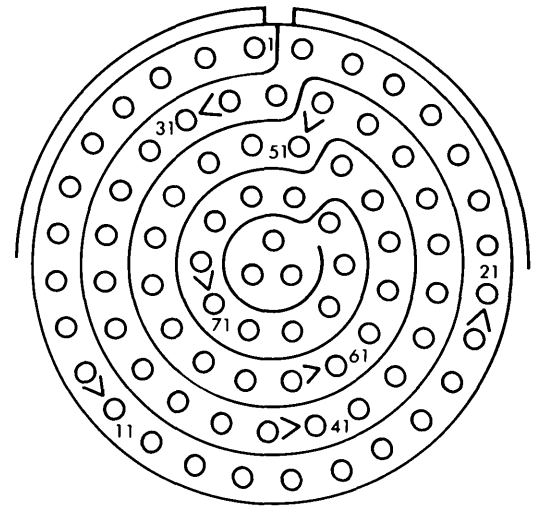

EL9LQ-1000-87

**P5-MS24767T21F35S**

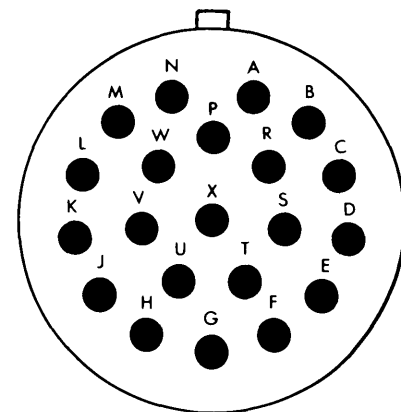

EL9LQ-1000-90

**P6 - PT06SE-22-21P (SR)**

3-32. TPS CABLE ASSEMBLIES (cont)

CABLE ASSEMBLY 13231512 WIRE LIST (cont)

FROM	TO	WIRE ID	WIRE SIZE	FROM	TO	WIRE ID	WIRE SIZE
P6-P	SPL7	257		P7-b1	P7-H2	246	24
P7-A1	SPL16	274	24	P7-b3	P7-H4	247	24
P7-A2	SPL17	276	24	P7-b5	P7-H5	248	24
P7-A3	SPL18	278	24	P7-c1	P7-H6	249	24
P7-A4	SPL20	94	24	P7-c3	P7-J1	250	24
P7-A5	SPL9	262	24	P8-A	P7-C4	237	24
P7-A6	SPL10	264	24	P8-B	P7-C6	239	24
P7-B1	SPL21	283	24	P8-C	P7-Z6	232	20
P7-C4	P1-V4	236	24	P8-D	P3-35	234	24
P7-C4	P8-A	237	24	P8-E	P3-47	235	24
P7-C5	SPL2	205	24	P8-F	P2-S1	233	20
P7-C6	P1-V5	238	24	P8-G	SPL1	204	20
P7-C6	P8-B	239	24	P8-H	SPL7	258	20
P7-D1	SPL3	209	24	P8-J	P1-E4	251	20
P7-D2	SPL4	214	24	SPL1	P4-a	201	18
P7-D3	SPL4	215	24	SPL1	P6-A	202	
P7-D4	SPL5	218	24	SPL1	P6-B	203	
P7-D5	SPL6	223	24	SPL1	P7-G4	199	24
P7-D6	SPL6	224	24	SPL1	P7-W2	200	24
P7-G2	P2-N2	57	24	SPL1	P8-G	204	20
P7-G3	P2-N5	58	24	SPL2	P4-d	208	18
P7-G4	SPL1	199	24	SPL2	P7-C5	205	24
P7-G5	SPL2	206	24	SPL2	P7-G5	206	24
P7-H2	P7-b1	246	24	SPL2	P7-W4	207	24
P7-H4	P7-b3	247	24	SPL3	P4-b	211	18
P7-H5	P7-b5	248	24	SPL3	P6-E	212	
P7-H6	P7-c1	249	24	SPL3	P6-F	213	
P7-J1	P7-c3	250	24	SPL3	P7-D1	209	24
P7-J2	SPL9	9	24	SPL3	P7-W6	210	24
P7-J3	SPL10	10	24	SPL4	P4-e	217	18
P7-J4	SPL16	18	24	SPL4	P7-D2	214	24
P7-J5	SPL17	24	24	SPL4	P7-D3	215	24
P7-J6	SPL18	25	24	SPL4	P7-X2	216	24
P7-K1	SPL20	95	24	SPL5	P4-c	220	18
P7-W2	SPL1	200	24	SPL5	P6-J	221	
P7-W4	SPL2	207	24	SPL5	P6-K	222	
P7-W6	SPL3	210	24	SPL5	P7-D4	218	24
P7-X2	SPL4	216	24	SPL5	P7-X4	219	24
P7-X4	SPL5	219	24	SPL6	P4-f	226	18
P7-Z4	SPL6	225	24	SPL6	P7-D5	223	24
P7-Z6	P8-C	232	20	SPL6	P7-D6	224	24

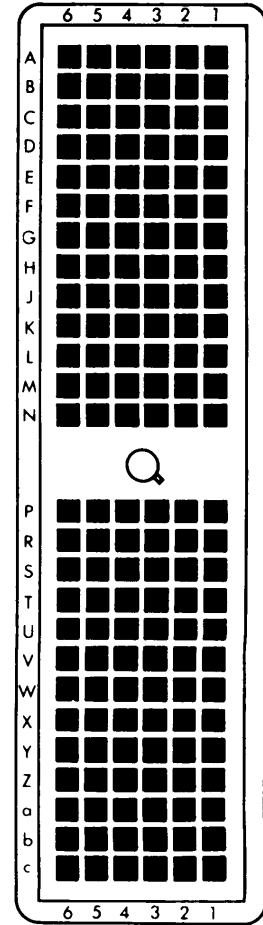

EL9LQ-1000-82A

**P7 - DL1-156P**

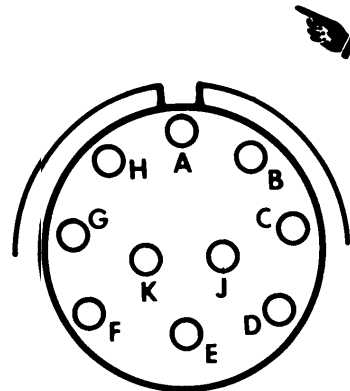

## CABLE ASSEMBLY 13231512 WIRE LIST (cont)

FROM	TO	WIRE ID	WIRE SIZE	FROM	TO	WIRE ID	WIRE SIZE
SPL6	P7-Z4	225	24	SPL19	P2-R4	78	24
SPL7	P1-a2	253	24	SPL19	P4-x	279	18
SPL7	P2-R3	254	24	SPL20	P3-18	281	24
SPL7	P4-g	255	18	SPL20	P7-A4	94	24
SPL7	P6-N	256		SPL20	P7-K1	95	24
SPL7	P6-P	257		SPL21	P1-J2	100	24
SPL7	P8-H	258	20	SPL21	P3-8	282	24
SPL8	P1-B4	260	24	SPL21	P7-B1	283	24
SPL8	P1-H2	8	24	SPL22	P1-b4	129	24
SPL8	P3-29	259	24	SPL22	P2-C2	130	24
SPL9	P3-78	261	24	SPL22	P2-N6	284	18
SPL9	P7-A5	262	24	SPL22	P4-p	285	18
SPL9	P7-J2	9	24	SPL23	P1-c4	139	24
SPL10	P3-89	263	24	SPL23	P2-W5	140	24
SPL10	P7-A6	264	24	SPL23	P4-F	286	20
SPL10	P7-J3	10	24	SPL24	P1-c6	143	24
SPL11	P2-G5	231	24	SPL24	P2-W3	144	24
SPL11	P2-V4	230	24	SPL24	P4-D	287	20
SPL11	P3-9	229	24	SPL25	P1-M4	43	24
SPL12	P1-B6	266	24	SPL25	P2-H6	44	24
SPL12	P1-H5	11	24	SPL25	P3-42	45	24
SPL12	P3-40	265	24	SPL26	P1-M5	46	24
SPL13	P1-C2	268	24	SPL26	P2-G1	47	24
SPL13	P1-J1	13	24	SPL26	P3-66	48	24
SPL13	P3-64	267	24	SPL27	P1-M6	49	24
SPL14	P1-A2	270	24	SPL27	P2-G2	50	24
SPL14	P1-J3	15	24	SPL27	P3-77	51	24
SPL14	P3-97	269	24	SPL28	P1-N5	52	24
SPL15	P1-A4	272	24	SPL28	P2-H5	53	24
SPL15	P1-J4	16	24	SPL28	P3-54	54	24
SPL15	P3-61	271	24				
SPL16	P3-30	273	24				
SPL16	P7-A1	274	24				
SPL16	P7-J4	18	24				
SPL17	P3-31	275	24				
SPL17	P7-A2	276	24				
SPL17	P7-J5	24	24				
SPL18	P3-51	277	24				
SPL18	P7-A3	278	24				
SPL18	P7-J6	25	24				
SPL19	P2-L6	280	24				

CABLE ASSEMBLY 13231598 WIRE LIST

FROM	TO	WIRE ID	WIRE SIZE
P1-21	P2-E	1	22
P1-J2	P2-F	2	22
P1-J3	P3-4	3	22
P1-J4	P3-11	4	22
P2-E	P1-J1	1	22
P2-F	P1-J2	2	22
P3-4	P1-J3	3	22
P3-11	P1-J4	4	22

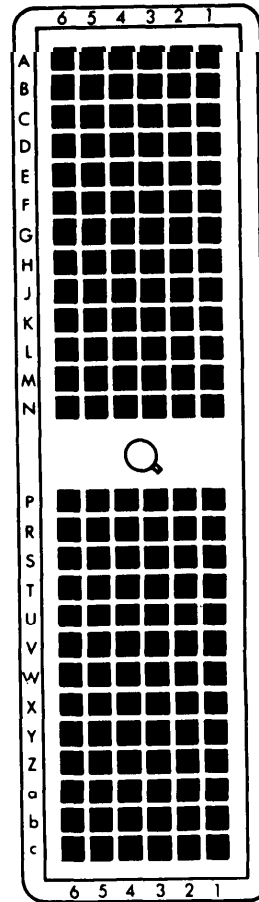

EL9LQ-1000-82A

P1 - DL1-156P

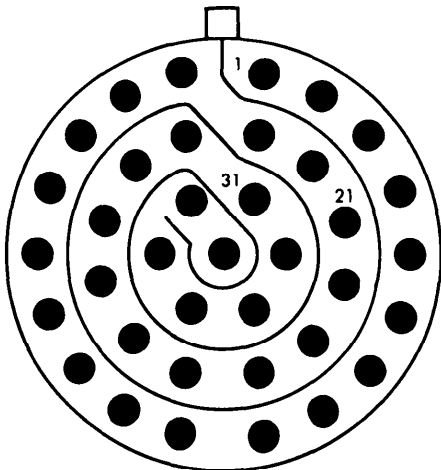

EL9LQ-1000-86

P3 - MS27467T15F35P

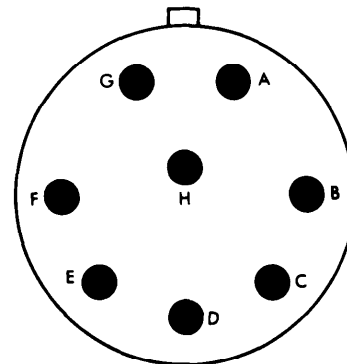

EL9LQ-1000-76

P2-MS27467T13F8P

CABLE ASSEMBLY 13231655 WIRE LIST

FROM	TO	WIRE ID	WIRE SIZE	FROM	TO	WIRE ID	WIRE SIZE
C1-1	P8-A		26	P2-N6	P3-20	42	26
C1-1	SPL 10		22	P2-S5	P8-C	78	22
C1-2	P8-C		26	P2-T1	P8-D	79	22
C2-1	P8-A		26	P2-T3	SPL 10	77	22
C2-1	SPL 10		26	P2-T5	SPL 9	70	22
C2-2	P8-D		26	P2-V2	STP4		20
J1-A	P2-E2	54	20	P3-1	SPL 6		26
J1-B	P2-C2	55	20	P3-2	STP3	81	26
J1-D	P2-D2	56	20	P3-3	P1-H4	15	26
P1-A1	P4-3	2	26	P3-4	P1-B1	16	26
P1-A3	STP1	7	22	P3-5	P1-a2	17	26
P1-A5	P3-17	26	26	P3-6	P1-a1	18	26
P1-B1	P3-4	16	26	P3-7	P1-D1	19	26
P1-B3	P3-15	24	26	P3-8	P2-N4	39	26
P1-B5	P3-18	27	26	P3-9	P2-N5	40	26
P1-C3	P4-9	6	26	P3-10	P1-E3	20	26
P1-C5	P4-7	5	26	P3-11	P2-M1	41	26
P1-D1	P3-7	19	26	P3-12	P1-U1	21	26
P1-D5	P4-1	1	26	P3-13	P1-U2	22	26
P1-E1	P4-6	4	26	P3-14	P1-U5	23	26
P1-E3	P3-10	20	26	P3-15	P1-B3	24	26
P1-F1	P4-5	3	26	P3-16	P1-M3	25	26
P1-H4	P3-3	15	26	P3-17	P1-A5	26	26
P1-M2	P3-19	28	26	P3-18	P1-B5	27	26
P1-M3	P3-16	25	26				
P1-U1	P3-12	21	26				
P1-U2	P3-13	22	26				
P1-U3	P3-24	29	26				
P1-U4	P3-25	30	26				
P1-U5	P3-14	23	26				
P1-a1	P3-6	18	26				
P1-a2	P3-5	17	26				
P2-A2	SPL 5	50	20				
P2-B2	SPL 4	46	20				
P2-C2	J1-B	55	20				
P2-D1	SPL 5	51	22				
P2-D2	J1-D	56	20				
P2-D3	SPL 4	47	22				
P2-E2	J1-A	54	20				
P2-K1	P3-23	43	26				
P2-M1	P3-11	41	26				
P2-N4	P3-8	39	26				
P2-N5	P3-9	40	26				

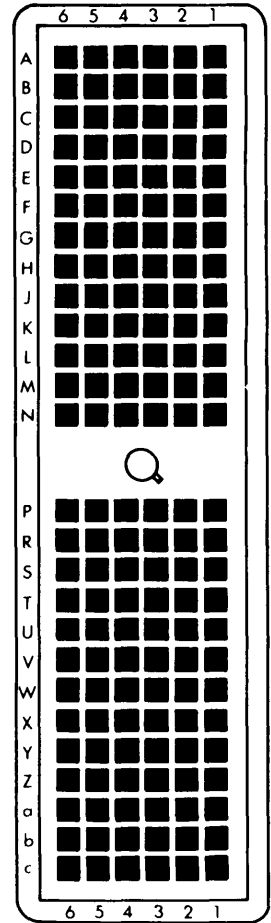

EL9LQ-1000-82A

P1 and P2-DL1-156P

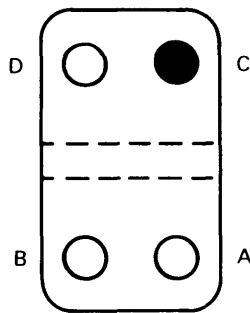

EL9LQ-1000-143

J1-SM-C-773505-2

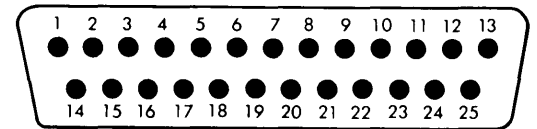

EL9LQ-1000-106

P3-MDM-25PHO411K

CABLE ASSEMBLY 13231655 WIRE LIST (cont)

FROM	TO	WIRE ID	WIRE SIZE	FROM	TO	WIRE ID	WIRE SIZE
P3-19	P1-M2	28	26	SPL 5	P3-22	83	26
P3-20	P2-N6	42	26	SPL 6	P3-1		26
P3-21	SPL 4	82	26	SPL 6	P5	44	COAX
P3-22	SPL 5	83	26	SPL 7	P9-A	65	16
P3-23	P2-K1	43	26	SPL 7	P9-B	66	16
P3-24	P1-U3	29	26	SPL 7	P9-C	67	16
P3-25	P1-U4	30	26	SPL 7	P9-D	68	16
P4-1	P1-D5	1	26	SPL 7	SPL 9	69	16
P4-2	SPL 2		26	SPL 8	P9-E	71	16
P4-3	P1-A1	2	26	SPL 8	P9-F	72	26
P4-4	SPL 3	80	26	SPL 8	P9-G	73	16
P4-5	P1-F1	3	26	SPL 8	P9-H	74	16
P4-6	P1-E1	4	26	SPL 8	SPL 10	75	16
P4-7	P1-C5	5	26	SPL 9	P2-T5	70	22
P4-8	STP2		26	SPL 9	P8-B	84	20
P4-9	P1-C3	6	26	SPL 9	SPL 7	69	16
P5	SPL 6	44	COAX	SPL 10	C1-1		22
P6	SPL 2	8	COAX	SPL 10	C2-1		22
P7	SPL 3	13	COAX	SPL 10	P2-T3	77	22
P8-A	C1-1		26	SPL 10	P8-A	85	22
P8-A	C2-1		26	SPL 10	SPL 8	75	16
P8-B	SPL 9	84	20	STP1	P1-A3	7	22
P8-C	C1-2		26	STP1	STP2		26
P8-C	P2-S5	78	22	STP2	P4-8		26
P8-D	C2-2		26	STP2	STP1		26
P8-D	P2-T1	79	22	STP3	P3-2	81	26
P9-A	SPL 7	65	16	STP4	P2-V2		20
P9-B	SPL 7	66	16				
P9-C	SPL 7	67	16				
P9-D	SPL 7	68	16				
P9-E	SPL 8	71	16				
P9-F	SPL 8	72	26				
P9-G	SPL 8	73	16				
P9-H	SPL 8	74	16				
SPL 2	P4-2		26				
SPL 2	P6	8	COAX				
SPL 3	P4-4	80	26				
SPL 3	P7	13	COAX				
SPL 4	P2-B2	46	20				
SPL 4	P2-D3	47	22				
SPL 4	P3-21	82	26				
P8-A	SPL 10	85	22				
SPL 5	P2-A2	50	20				
SPL 5	P2-D1	51	22				

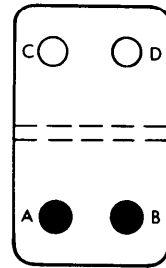

EL9LQ-1000-62A  
P8-SM-C-773505-4

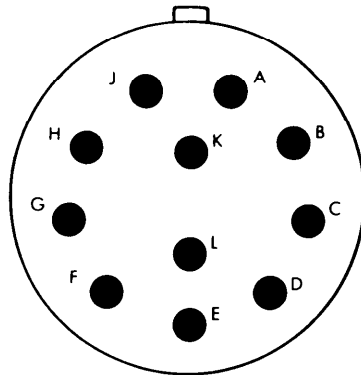

EL9LQ-1000-48  
P9-MS3476F18-11P

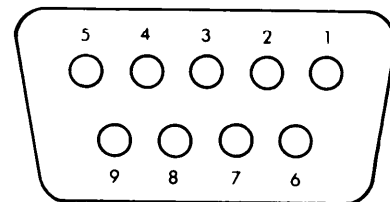

EL9LQ-1000-107  
P4-MDM-9SH041K



CABLE ASSEMBLY 13082831-509 WIRE LIST

FROM	TO	WIRE ID	WIRE SIZE	FROM	TO	WIRE ID	WIRE SIZE
P1-A1	P1-b5	1	24	P1-F6	P9-124	35	24
P1-A2	P3-P3	2	24	P1-G1	P9-106	35	24
P1-A3	P3-P4	3	24	P1-G2	P5-95	36	24
P1-A4	P1-L6	4	24	P1-G3	P5-106	36	24
P1-A5	P1-M1	5	24	P1-G4	P5-105	37	24
P1-A6	P3-P5	6	24	P1-G5	P5-97	37	24
P1-B1	P5-35	7	24	P1-G6	P7-8	38	24
P1-B2	P8-37	8	24	P1-G6	P13-8	363	26
P1-B3	P3-R1	9	24	P1-H1	SPL5	176	24
P1-B4	P8-58	10	24	P1-H2	P7-11	39	SHLD
P1-B5	P2-N3	11	24	P1-H2	P13-11	365	26
P1-B6	P8-93	12	24	P1-H3	SPL5	177	24
P1-C1	P8-103	13	24	P1-H4	P7-4	40	24
P1-C2	P2-N4	14	24	P1-H4	P13-4	367	26
P1-C3	P2-M4	16	24	P1-H5	P7-20	41	24
P1-C4	P5-122	18	24	P1-H5	P13-20	368	26
P1-C5	P5-116	18	24	P1-H6	P7-25	42	24
P1-C6	P8-23	20	24	P1-H6	P13-25	369	26
P1-D1	P8-33	20	24	P1-J1	P10-106	43	24
P1-D2	P8-25	22	24	P1-J2	P10-94	43	24
P1-D3	P8-108	22	24	P1-J3	P7-33	45	24
P1-D4	P8-79	23	24	P1-J3	P13-33	370	26
P1-D5	P8-81	23	24	P1-J4	P7-17	46	24
P1-D6	P8-96	24	24	P1-J4	P13-19	374	26
P1-E1	P8-116	24	24	P1-J6	P3-H5	141	24
P1-E2	P8-122	25	24	P1-J6	P10-118	47	26
P1-E3	P8-107	25	24	P1-K1	P7-28	64	24
P1-E4	P9-24	26	24	P1-K1	P13-28	366	26
P1-E5	P9-19	26	24	P1-K2	P8-6	65	24
P1-E6	P2-G5	28	24	P1-K3	P8-19	65	24
P1-E6	P9-93	29	24	P1-K4	P3-J6	66	24
P1-F1	P2-G6	30	24	P1-K4	P8-20	67	24
P1-F1	P9-90	29	24	P1-K5	P3-K1	68	24
P1-F2	P9-94	31	24	P1-K5	P8-11	67	24
P1-F3	P9-109	31	24	P1-K6	P3-a1	69	24
P1-F4	P3-X5	33	24	P1-K6	P10-11	75	24
P1-F4	P9-113	32	24	P1-L1	P3-a2	70	24
P1-F5	P3-X6	34	24	P1-L1	P10-34	75	24
P1-F5	P9-114	32	24	P1-L2	P2-F3	71	24
				P1-L2	P10-19	76	24
				P1-L3	P2-H1	72	24

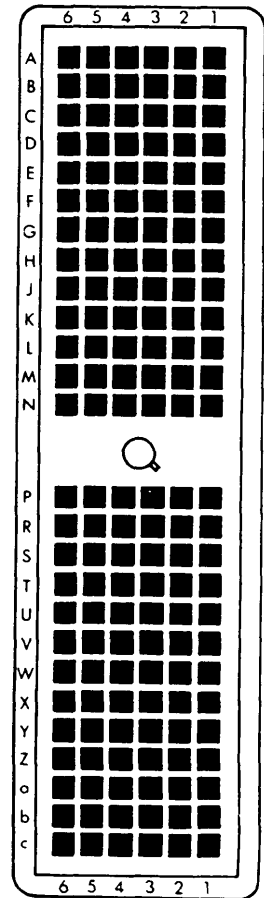

EL9LQ-1000-82A

P1-13081528-1

## CABLE ASSEMBLY 13082831-509 WIRE LIST (cont)

FROM	TO	WIRE ID	WIRE SIZE	FROM	TO	WIRE ID	WIRE SIZE
P1-L3	P10-58	76	24	P1-S6	P8-14	104	24
P1-L4	P3-Z5	73	24	P1-STP1	P5 OPEN	18	SHLD
P1-L4	P10-21	77	24	P1-STP1	SPL1	18	SHLD
P1-L5	P3-Z6	74	24	P1-STP2	P8 OPEN	20	SHLD
P1-L5	P10-12	77	24	P1-STP2	SPL2	20	SHLD
P1-L6	P1-A4	4	24	P1-STP3	P8 OPEN	22	SHLD
P1-L6	P10-79	78	24	P1-STP3	SPL2	22	SHLD
P1-M1	P1-A5	5	24	P1-STP4	P8 OPEN	23	SHLD
P1-M1	P10-3	78	24	P1-STP4	SPL2	23	SHLD
P1-M2	P8-106	79	24	P1-STP5	P8 OPEN	24	SHLD
P1-M3	P8-115	79	24	P1-STP5	SPL2	24	SHLD
P1-M4	P9-126	80	24	P1-STP6	P8 OPEN	25	SHLD
P1-M5	P9-119	80	24	P1-STP6	SPL2	25	SHLD
P1-M6	P3-W1	82	24	P1-STP7	P9 OPEN	26	SHLD
P1-M6	P8-3	83	24	P1-STP7	SPL4	26	SHLD
P1-N1	P3-W2	84	24	P1-STP8	P9 OPEN	29	SHLD
P1-N1	P8-4	83	24	P1-STP8	SPL4	29	SHLD
P1-N2	P2-Y1	85	24	P1-STP9	P9 OPEN	31	SHLD
P1-N3	P2-Y2	86	24	P1-STP9	SPL4	31	SHLD
P1-N4	P10-14	87	24	P1-STP10	P9 OPEN	32	SHLD
P1-N5	P10-44	87	24	P1-STP10	SPL	32	SHLD
P1-N6	P10-47	88	24	P1-STP11	P9 OPEN	35	SHLD
P1-P1	P10-5	88	24	P1-STP11	SPL4	35	SHLD
P1-P2	P10-56	89	24	P1-STP12	P5 OPEN	36	SHLD
P1-P3	P10-22	89	24	P1-STP12	SPL1	36	SHLD
P1-P4	P10-115	90	24	P1-STP13	P5 OPEN	37	SHLD
P1-P5	P10-110	90	24	P1-STP13	SPL1	37	SHLD
P1-P6	P3-J5	91	24	P1-STP14	P10 OPEN	43	SHLD
P1-R1	P9-81	92	24	P1-STP14	SPL5	43	SHLD
P1-R2	P2-Y3	93	24	P1-STP15	P8 OPEN	65	SHLD
P1-R3	P10-102	94	24	P1-STP15	SPL2	65	SHLD
P1-R4	P9-110	96	24	P1-STP16	P8 OPEN	67	SHLD
P1-R4	P10-33	95	24	P1-STP16	SPL3	67	SHLD
P1-R5	P10-122	97	24	P1-STP17	P10 OPEN	75	SHLD
P1-R6	P3-K4	395	24	P1-STP17	SPL5	75	SHLD
P1-R6	P10-113	98	24	P1-STP18	P10 OPEN	76	SHLD
P1-S1	P2-Y4	99	24	P1-STP18	SPL5	76	SHLD
P1-S2	P5-85	100	24	P1-STP19	P10 OPEN	77	SHLD
P1-S3	P5-82	101	24	P1-STP19	SPL5	77	SHLD
P1-S4	P10-107	102	24	P1-STP20	P10 OPEN	78	SHLD
P1-S5	P3-K3	103	24	P1-STP20	SPL5	78	SHLD

## 3-32. TPS CABLE ASSEMBLIES (cont)

3-32

## CABLE ASSEMBLY 13082831-509 WIRE LIST (cont)

FROM	TO	WIRE ID	WIRE SIZE	FROM	TO	WIRE ID	WIRE SIZE
P1-STP21	P8 OPEN	79	SHLD	P1-U3	P2-X1	118	24
P1-STP21	SPL3	79	SHLD	P1-U4	P8-30	119	24
P1-STP22	P9 OPEN	80	SHLD	P1-U5	P8-42	119	24
P1-STP22	SPL4	80	SHLD	P1-U6	P2-Z4	120	24
P1-STP23	P8 OPEN	83	SHLD	P1-U6	P8-8	121	24
P1-STP23	SPL3	83	SHLD	P1-V1	P2-Z5	122	24
P1-STP24	P10 OPEN	87	SHLD	P1-V1	P8-16	123	24
P1-STP24	SPL5	87	SHLD	P1-V2	P9-63	140	24
P1-STP25	P10 OPEN	88	SHLD	P1-V3	P2-Y5	125	24
P1-STP25	SPL5	88	SHLD	P1-V4	P9-64	140	24
P1-STP26	P10 OPEN	89	SHLD	P1-V5	P10-29	127	24
P1-STP26	SPL5	89	SHLD	P1-V6	P8-5	104	24
P1-STP27	P10 OPEN	90	SHLD	P1-W1	P3-X1	128	24
P1-STP27	SPL5	90	SHLD	P1-W1	P5-11	129	24
P1-STP28	P8 OPEN	104	SHLD	P1-W2	P8-92	130	26
P1-STP28	SPL3	104	SHLD	P1-W2	P8-104	131	26
P1-STP29	P9-OPEN	140	24	P1-W3	P3-K5	136	24
P1-STP29	SPL4	139	24	P1-W3	P10-120	132	24
P1-STP30	P8 OPEN	119	SHLD	P1-W4	P8-80	133	24
P1-STP30	SPL3	119	SHLD	P1-W5	P8-111	134	24
P1-STP31	P5 OPEN	137	SHLD	P1-W6	P8-118	135	24
P1-STP31	SPL1	137	SHLD	P1-X1	P5-18	137	24
P1-STP32	P5 OPEN	138	SHLD	P1-X2	P5-27	138	24
P1-STP32	SPL1	138	SHLD	P1-X3	P5-38	138	24
P1-STP33	SPL4	140	SHLD	P1-X4	P3-W5	381	24
P1-STP33	P9 OPEN	140	SHLD	P1-X4	P5-17	382	24
P1-STP34	P9 OPEN	175	SHLD	P1-X5	P3-W6	381	24
P1-STP34	SPL4	175	SHLD	P1-X5	P5-8	382	24
P1-STP64	SPL13	382	24	P1-X6	P8-18	142	24
P1-STP64	P5-OPEN	382	24	P1-Y1	P8-10	143	24
P1-T1	P7-14	106	26	P1-Y2	P2-X4	144	24
P1-T1	P13-18	373	26	P1-Y3	P5-1	145	24
P1-T2	P5-71	108	24	P1-Y4	P5-16	147	24
P1-T2	P9-127	107	24	P1-Y4	P5-28	146	24
P1-T3	P7-16	109	26	P1-Y5	P5-26	148	24
P1-T3	P13-16	372	26	P1-Y6	P5-23	150	24
P1-T4	P5-126	110	24	P1-Y6	P5-39	149	24
P1-T5	P2-W4	111	24	P1-Z2	P5-15	153	24
P1-T6	P2-Z1	112	24	P1-Z3	P9-76	139	24
P1-T6	P8-22	113	24				
P1-U1	P2-Z2	114	24				
P1-U1	P8-45	115	24				
P1-U2	P2-W6	117	24				

CABLE ASSEMBLY 13082831-509 WIRE LIST (cont)

FROM	TO	WIRE ID	WIRE SIZE	FROM	TO	WIRE ID	WIRE SIZE
P1-Z4	P5-25	137	24	P2-F5	P5-124	196	24
P1-Z5	P3-W4	156	24	P2-F6	P5-91	340	24
P1-Z5	P5-21	57	24	P2-F6	P5-90	197	24
P1-Z6	P9-77	139	24	P2-G5	P1-E6	28	24
P1-a1	P3-W3	160	24	P2-G6	P1-F1	30	24
P1-a2	P5-36	161	24	P2-H1	P1-L3	72	24
P1-a3	P2-Z3	162	24	P2-H2	P10-45	205	24
P1-a4	P2-a6	163	24	P2-H3	P7-21	198	26
P1-a5	P9-18	164	24	P2-H3	P13-46	359	26
P1-a5	P9-96	165	24	P2-H4	P7-26	199	26
P1-a6	P2-a5	166	24	P2-H4	P13-48	360	26
P1-b1	P8-127	167	24	P2-H5	P7-9	200	26
P1-b2	P10-97	168	24	P2-H5	P13-50	361	26
P1-b2	P10-99	169	24	P2-H6	P7-23	201	26
P1-b3	P3-E6	170	24	P2-H6	P13-51	362	26
P1-b3	P8-1	171	24	P2-J1	P6-B	202	24
P1-b4	P10-89	172	26	P2-J2	P10-25	203	24
P1-b4	P10-112	173	26	P2-J3	P10-35	203	24
P1-b5	P1-A1	1	24	P2-J4	P10-32	204	24
P1-b5	P5-12	174	24	P2-J5	P10-1	204	24
P1-b6	P9-95	175	24	P2-J6	P10-46	205	24
P1-c1	P9-80	175	24	P2-K1	P5-119	207	24
P1-c2	P2-X5	250	24	P2-K1	P5-128	206	24
P1-c3	P10-100	178	24	P2-K2	P5-102	392	24
P1-c4	P2-Y6	180	24	P2-K2	P5-103	208	24
P1-c4	P10-119	179	24	P2-K3	P8-128	210	26
P2-A2	P2-L1	181	24	P2-K4	P8-21	215	24
P2-A4	P2-L2	183	24	P2-K5	P8-12	215	24
P2-A6	P2-L3	185	24	P2-K6	P6-A	216	24
P2-B2	P9-5	187	24	P2-L1	P2-A2	181	24
P2-B4	P9-12	188	24	P2-L1	P5-127	182	24
P2-B6	P9-14	189	24	P2-L2	P2-A4	183	24
P2-C2	P9-20	190	24	P2-L2	P5-13	184	24
P2-C4	P9-44	191	24	P2-L3	P2-A6	185	24
P2-C6	P9-46	192	24	P2-L3	P5-99	186	24
P2-D2	P9-82	193	24	P2-L4	P3-Z3	218	24
P2-D4	P5-113	209	24	P2-L4	P5-33	217	24
P2-D6	P9-123	195	24	P2-L5	P3-Z4	220	24
P2-E2	P5-109	124	24	P2-L5	P5-6	219	24
P2-E2	P5-74	126	24	P2-L6	P7-3	221	24
P2-F2	SPL7	262	24	P2-L6	P13-3	364	26
P2-F3	P1-L2	71	24				

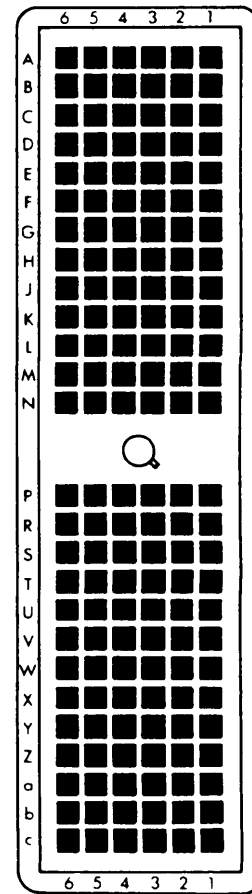

EL9LQ-1000-82A

P2 and P3-DL1-156P

## 3-32. TPS CABLE ASSEMBLIES (cont)

3-32

## CABLE ASSEMBLY 13082831 -509 WIRE LIST (cont)

FROM	TO	WIRE ID	WIRE SIZE	FROM	TO	WIRE ID	WIRE SIZE
P2-M1	P3-Y3	223	24	P2-STP39	P10 OPEN	230	SHLD
P2-M1	P5-123	222	24	P2-STP39	SPL6	230	SHLD
P2-M2	P5-100	350	24	P2-STP40	P9 OPEN	240	SHLD
P2-M2	SPL9	351	24	P2-STP40	SPL7	240	SHLD
P2-M3	P5-112	224	24	P2-STP41	P9 OPEN	241	SHLD
P2-M4	P1-C3	16	24	P2-STP41	SPL7	241	SHLD
P2-M4	P5-58	17	24	P2-STP42	P9 OPEN	249	SHLD
P2-M5	P5-46	225	24	P2-STP42	SPL7	249	SHLD
P2-M6	P7-1	226	26	P2-STP43	P5 OPEN	260	SHLD
P2-M6	P13-35	371	26	P2-STP43	SPL7	260	SHLD
P2-N1	P3-b4	227	24	P2-STP44	P8 OPEN	261	SHLD
P2-N2	P3-b5	228	24	P2-STP44	SPL7	261	SHLD
P2-N3	P1-B5	11	24	P2-T1	P2-V5	244	24
P2-N3	P5-118	229	24	P2-T2	P2-V6	245	24
P2-N4	P1-C2	14	24	P2-T3	P2-W1	246	24
P2-N4	P5-24	15	24	P2-T4	P2-W2	247	24
P2-N5	P10-8	230	24	P2-T5	P2-W3	248	24
P2-N6	P10-16	230	24	P2-T6	P9-13	249	24
P2-P5	P10-24	232	24	P2-U1	P3-P2	242	24
P2-P6	P2-V4	233	24	P2-U2	P2-S6	243	24
P2-R1	P2-U3	234	24	P2-U3	P2-R1	234	24
P2-R2	P2-U4	235	24	P2-U4	P2-R2	235	24
P2-R3	P2-U5	236	24	P2-U5	P2-R3	236	24
P2-R4	P2-U6	237	24	P2-U6	P2-R4	237	24
P2-R5	P2-V1	238	24	P2-V1	P2-R5	238	24
P2-R6	P2-V2	239	24	P2-V2	P2-R6	239	24
P2-S1	P9-47	240	24	P2-V3	P9-92	194	24
P2-S2	P9-57	240	24	P2-V4	P2-P6	233	24
P2-S3	P9-22	241	24	P2-V5	P2-T1	244	24
P2-S4	P9-70	241	24	P2-V6	P2-T2	245	24
P2-S5	P9-7	249	24	P2-W1	P2-T3	246	24
P2-S6	P2-U2	243	24	P2-W2	P2-T4	247	24
P2-STP35	P10 OPEN	203	SHLD	P2-W3	P2-T5	248	24
P2-STP35	SPL6	203	SHLD	P2-W4	P1-T5	111	24
P2-STP36	P10 OPEN	204	SHLD	P2-W5	P2-c6	116	24
P2-STP36	SPL6	204	SHLD	P2-W6	P1-U2	117	24
P2-STP37	P10 OPEN	205	SHLD	P2-X1	P1-U3	118	24
P2-STP37	SPL6	205	SHLD	P2-X2	P3-V5	152	24
P2-STP38	P8 OPEN	215	SHLD	P2-X4	P1-Y2	144	24
P2-STP38	SPL6	215	SHLD	P2-X5	P1-c2	250	24
				P2-X6	P7-29	393	26

CABLE ASSEMBLY 13082831-509 WIRE LIST (cont)

FROM	TO	WIRE ID	WIRE SIZE	FROM	TO	WIRE ID	WIRE SIZE
P2-X6	P13-29	375	26	P3-B6	P2-c1	259	24
P2-Y1	P1-N2	85	24	P3-C2	P7-24	274	26
P2-Y2	P1-N3	86	24	P3-C2	P13-40	356	26
P2-Y3	P1-R2	93	24	P3-C4	P10-2	275	24
P2-Y4	P1-S1	99	24	P3-C6	P10-4	276	24
P2-Y5	P1-V3	125	24	P3-D2	P7-10	277	26
P2-Y6	P1-c4	180	24	P3-D2	P13-42	357	26
P2-Z1	P1-T6	112	24	P3-D4	P10-6	278	24
P2-Z2	P1-U1	114	24	P3-D6	P10-9	279	24
P2-Z3	P1-a3	162	24	P3-E2	P7-27	280	26
P2-Z4	P1-U6	120	24	P3-E2	P13-44	358	26
P2-Z5	P1-V1	122	24	P3-E4	P10-13	281	24
P2-Z6	P5-47	263	24	P3-E6	P1-b3	170	24
P2-a1	P5-107	264	24	P3-F2	SPL8	324	24
P2-a2	P5-115	265	24	P3-F4	P9-103	151	24
P2-a3	P5-125	266	24	P3-F6	P12-6	282	26
P2-a4	P8-9	267	24	P3-G1	P8-57	283	24
P2-a5	P1-a6	166	24	P3-G2	P8-101	284	24
P2-a5	P8-17	268	24	P3-G3	P8-119	285	24
P2-a6	P1-a4	163	24	P3-G4	P8-124	286	24
P2-b1	P5-117	251	24	P3-G5	P8-126	287	24
P2-b2	P5-67	252	22	P3-H1	P9-79	288	24
P2-b2	P5-68	253	22	P3-H2	P9-128	289	24
P2-b3	P10-23	254	24	P3-H3	P10-7	290	24
P2-b4	P5-111	255	24	P3-H4	P10-10	291	24
P2-b5	P5-110	256	24	P3-H5	P1-J6	141	24
P2-b6	P9-56	257	24	P3-H6	P10-103	384	26
P2-c1	P3-B6	259	24	P3-J3	SPL11	377	24
P2-c1	P8-24	258	24	P3-J4	SPL12	377	24
P2-c2	P5-14	260	24	P3-J5	P1-P6	91	24
P2-c3	P5-7	260	24	P3-J6	P1-K4	66	24
P2-c4	P8-47	261	24	P3-K1	P1-K5	68	24
P2-c5	P8-44	261	24	P3-K2	P3-T2	296	24
P2-c6	P2-W5	116	24	P3-K3	P1-S5	103	24
P3 OPEN	P9 STP58	377	SHLD	P3-K4	P1-R6	395	24
P3-A2	P7-5	269	26	P3-K5	P1-W3	136	24
P3-A2	P13-36	354	26	P3-K6	P11-22	296	26
P3-A4	P9-121	270	24	P3-L1	P11-25	297	26
P3-A6	P9-122	271	24	P3-L2	P12-27	298	26
P3-B2	P7-6	272	26	P3-L3	P8-56	299	24
P3-B2	P13-38	355	26	P3-L4	P8-90	300	24
P3-B4	P9-125	273	24	P3-L5	P8-95	301	24
				P3-L6	P8-117	302	24

## 3-32. TPS CABLE ASSEMBLIES (cont)

3-32

## CABLE ASSEMBLY 13082831-509 WIRE LIST (cont)

FROM	TO	WIRE ID	WIRE SIZE	FROM	TO	WIRE ID	WIRE SIZE
P3-M1	P8-123	303	24	P3-STP49	P8 OPEN	320	SHLD
P3-M2	P9-21	304	24	P3-STP49	SPL8	320	SHLD
P3-M3	P9-102	305	24	P3-STP50	P5 OPEN	323	SHLD
P3-M4	P9-104	306	24	P3-STP50	SPL8	323	SHLD
P3-M5	P9-107	307	24	P3-STP62	SPL8	381	SHLD
P3-M6	P9-108	308	24	P3-STP63	P9 OPEN	389	SHLD
P3-N1	P9-111	309	24	P3-STP63	SPL8	389	SHLD
P3-N2	P9-112	310	24	P3-T2	P3-K2	296	24
P3-N3	P9-115	311	24	P3-T6	P8-125	327	24
P3-N4	P9-116	312	24	P3-U2	P8-70	154	24
P3-N5	P9-117	313	24	P3-U2	P8-102	155	24
P3-N6	P9-118	314	24	P3-V3	P9-105	389	24
P3-P1	P8-114	315	24	P3-V2	P8-91	158	24
P3-P2	P2-U1	242	24	P3-V2	P8-112	159	24
P3-P3	P1-A2	2	24	P3-V4	P9-91	389	24
P3-P3	P10-57	316	24	P3-V5	P2-X2	152	24
P3-P4	P1-A3	3	24	P3-V6	P3-X2	330	24
P3-P4	P10-126	316	24	P3-V6	P5-4	331	24
P3-P5	P1-A6	6	24	P3-W1	P1-M6	82	24
P3-P5	P10-109	317	24	P3-W2	P1-N1	84	24
P3-P6	P8-46	318	24	P3-W3	P1-a1	160	24
P3-R1	P1-B3	9	24	P3-W4	P1-Z5	156	24
P3-R1	P10-124	317	24	P3-W5	P1-X4	382	24
P3-R2	P8-35	319	24	P3-W6	P1-X5	381	24
P3-R3	P8-7	319	24	P3-X1	P1-W1	128	24
P3-R4	P8-105	320	24	P3-X2	P3-V6	330	24
P3-R5	P8-94	320	24	P3-X3	P5-120	332	24
P3-R6	P5-86	321	24	P3-X4	P5-81	333	24
P3-R6	P5-87	322	24	P3-X5	P1-F4	33	24
P3-S1	P8-113	315	24	P3-X6	P1-F5	34	24
P3-S2	P5-84	323	24	P3-Y1	P10-62	19	24
P3-S3	P5-83	323	24	P3-Y2	P10-63	21	24
P3-S4	P8-34	325	24	P3-Y3	P2-M1	223	24
P3-S6	P8-121	326	24	P3-Y4	P5-94	335	24
P3-STP45	P8 OPEN	315	SHLD	P3-Y5	P5-96	334	24
P3-STP45	SPL8	315	SHLD	P3-Y6	P5-69	336	24
P3-STP46	P10 OPEN	316	SHLD	P3-Y6	P5-70	337	24
P3-STP46	SPL8	316	SHLD	P3-Z1	P5-79	338	24
P3-STP47	P10 OPEN	317	SHLD	P3-Z1	P5-80	339	24
P3-STP47	SPL8	317	SHLD	P3-Z2	P5-81	340	24
P3-STP48	P8 OPEN	319	SHLD	P3-Z2	P5-93	341	24
P3-STP48	SPL8	319	SHLD	P3-Z3	P2-L4	218	24
				P3-Z4	P2-L5	220	24
				P3-Z5	P1-L4	73	24

CABLE ASSEMBLY 13082831-509 WIRE LIST (cont)

FROM	TO	WIRE ID	WIRE SIZE
P3-Z6	P1-L5	74	24
P3-a1	P1-K6	69	24
P3-a2	P1-L1	70	24
P3-b4	P2-N1	227	24
P3-b5	P2-N2	228	24
P4-A7	P9-17	342	24
P4-A8	P9-1	342	24
P4-B4	P4-STP51	342	SHLD
P4-B7	SPL10	349	24
P4-B8	P4-STP52	343	SHLD
P4-C7	P9-8	343	24
P4-C8	P9-6	343	24
P4-D7	P9-45	344	24
P4-D8	P9-34	344	24
P4-E4	P4-STP53	344	SHLD
P4-F7	P9-50	345	24
P4-F8	P9-61	345	24
P4-H7	P9-3	346	24
P4-H8	P9-11	346	24
P4-K3	P9-32	347	24
P4-K4	P9-35	347	24
P4-L3	SPL11	378	24
P4-L4	SPL12	378	24
P4-M3	P9-23	348	24
P4-M4	P9-33	348	24
P4-STP51	P4-B4	342	SHLD
P4-STP51	P9 OPEN	342	SHLD
P4-STP52	P4-B8	343	SHLD
P4-STP52	P9-OPEN	343	SHLD
P4-STP53	P4-E4	344	SHLD
P4-STP53	P9 OPEN	344	SHLD
P4-STP54	P9 OPEN	345	SHLD
P4-STP54	SPL10	345	SHLD
P4-STP55	P9 OPEN	346	SHLD
P4-STP55	SPL10	346	SHLD
P4-STP56	P9 OPEN	347	SHLD
P4-STP56	SPL10	347	SHLD
P4-STP57	P9 OPEN	348	SHLD
P4-STP57	SPL10	348	SHLD
P4-STP59	SPL14	378	SHLD
P4-STP60	SPL10	378	SHLD

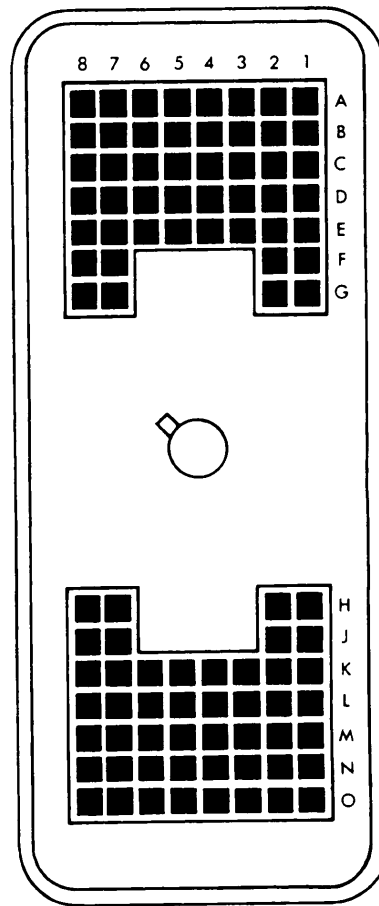

EL9LQ-1000-85 A

P4-DL2-96P



CABLE ASSEMBLY 13082831-509 WIRE LIST (cont)

FROM	TO	WIRE ID	WIRE SIZE
P5 OPEN	P1-STP1	18	SHLD
P5 OPEN	P1-STP12	36	SHLD
P5 OPEN	P1-STP13	37	SHLD
P5 OPEN	P1-STP31	137	SHLD
P5 OPEN	P1-STP32	138	SHLD
P5 OPEN	P2-STP43	260	SHLD
P5 OPEN	P3-STP50	323	SHLD
P5 OPEN	P1-STP64	382	24
P5-1	P1-Y3	145	24
P5-2	P1-Z5	157	24
P5-4	P3-V6	331	24
P5-6	P2-L5	219	24
P5-7	P2-c3	260	24
P5-8	P1-X5	383	24
P5-11	P1-W1	129	24
P5-12	P1-b5	174	24
P5-13	P2-L2	184	24
P5-14	P2-c2	260	24
P5-15	P1-Z2	153	24
P5-16	P1-Y4	147	24
P5-17	P1-X4	382	24
P5-18	P1-X1	137	24
P5-23	P1-Y6	150	24
P5-24	P2-N4	15	24
P5-25	P1-Z4	137	24
P5-26	P1-Y5	148	24
P5-27	P1-X2	138	24
P5-28	P1-Y4	146	24
P5-33	P2-L4	217	24
P5-35	P1-B1	7	24
P5-36	P1-a2	161	24
P5-38	P1-X3	138	24
P5-39	P1-Y6	149	24
P5-46	P2-M5	225	24
P5-47	P2-Z6	263	24
P5-58	P2-M4	17	24
P5-67	P2-b2	252	22
P5-68	P2-b2	253	22
P5-69	P3-Y6	336	24
P5-70	P3-Y6	337	24
P5-71	P1-T2	108	24

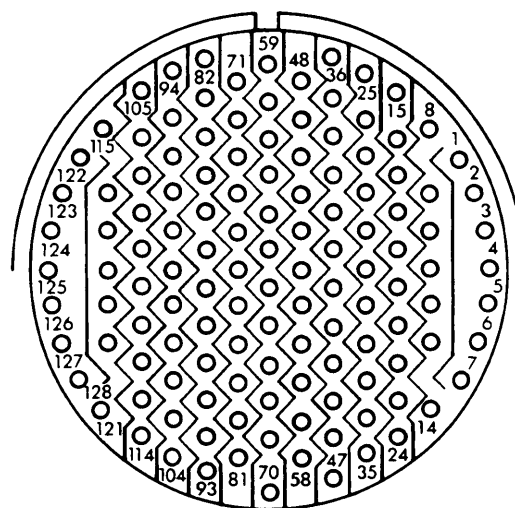

EL9LQ-1000-2

P5-MS27467T25F35S

## 3-32. TPS CABLE ASSEMBLIES (cont)

3-32

## CABLE ASSEMBLY 13082831-509 WIRE LIST (cont)

FROM	TO	WIRE ID	WIRE SIZE
P5-74	P2-E2	126	24
P5-79	P3-Z1	338	24
P5-80	P3-Z1	339	24
P5-81	P3-X4	333	24
P5-81	P3-Z2	340	24
P5-82	P1-S3	101	24
P5-83	P3-S3	323	24
P5-84	P3-S2	323	24
P5-85	P1-S2	100	24
P5-86	P3-R6	321	24
P5-87	P3-R6	322	24
P5-90	P2-F6	197	24
P5-91	P2-F6	340	24
P5-93	P3-Z2	341	24
P5-94	P3-Y4	335	24
P5-95	P1-G2	36	24
P5-96	P3-Y5	334	24
P5-97	P1-G5	37	24
P5-99	P2-L3	186	24
P5-100	P2-M2	350	24
P5-102	P2-K2	392	24
P5-103	P2-K2	208	24
P5-105	P1-G4	37	24
P5-106	P1-G3	36	24
P5-107	P2-a1	264	24
P5-109	P2-E2	124	24
P5-110	P2-b5	256	24
P5-111	P2-b4	255	24
P5-112	P2-M3	224	24
P5-113	P2-D4	209	24
P5-115	P2-a2	265	24
P5-116	P1-C5	18	24
P5-117	P2-b1	251	24
P5-118	P2-N3	229	24
P5-119	P2-K1	207	24
P5-120	P3-X3	332	24
P5-122	P1-C4	18	24
P5-123	P2-M1	222	24
P5-124	P2-F5	196	24
P5-125	P2-a3	266	24
P5-126	P1-T4	110	24
P5-127	P2-L1	182	24
P5-128	P2-K1	206	24

CABLE ASSEMBLY 13082831-509 WIRE LIST (cont)

FROM	TO	WIRE ID	WIRE SIZE
P6-A	P2-K6	216	24
P6-B	P2-J1	202	24
P7-1	P2-M6	226	26
P7-3	P2-L6	221	24
P7-4	P1-H4	40	24
P7-5	P3-A2	269	26
P7-6	P3-B2	272	24
P7-7	SPL9	353	26
P7-8	P1-G6	38	24
P7-9	P2-H5	200	26
P7-10	P3-D2	277	26
P7-11	P1-H2	39	SHLD
P7-13	SPL9	354	26
P7-14	P1-T1	106	26
P7-16	P1-T3	109	26
P7-17	P1-J4	46	24
P7-20	P1-H5	41	24
P7-21	P2-H3	198	26
P7-23	P2-H6	201	26
P7-24	P3-C2	274	26
P7-25	P1-H6	42	24
P7-26	P2-H4	199	26
P7-27	P3-E2	280	26
P7-28	P1-K1	64	24
P7-29	P2-X6	393	26
P7-33	P1-J3	45	24
P8 OPEN	P1-STP2	20	SHLD
P8 OPEN	P1-STP3	22	SHLD
P8 OPEN	P1-STP4	23	SHLD
P8 OPEN	P1-STP5	24	SHLD
P8 OPEN	P1-STP6	25	SHLD
P8 OPEN	P1-STP15	65	SHLD
P8 OPEN	P1-STP16	67	SHLD
P8 OPEN	P1-STP21	79	SHLD
P8 OPEN	P1-STP23	83	SHLD
P8 OPEN	P1-STP28	104	SHLD
P8 OPEN	P1-STP30	119	SHLD
P8 OPEN	P2-STP38	215	SHLD
P8 OPEN	P2-STP44	261	SHLD
P8 OPEN	P3-STP45	315	SHLD
P8 OPEN	P3-STP48	319	SHLD
P8 OPEN	P3-STP49	320	SHLD

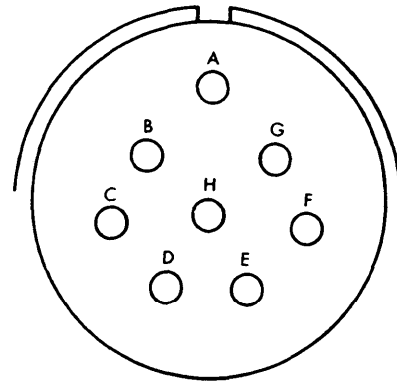

EL9LQ-1000-19

**P6-MS27467T17F8S**

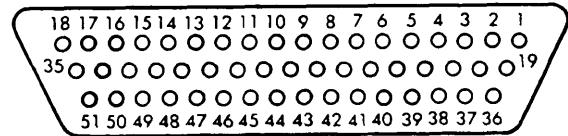

EL9LQ-1000-98

**P7 - MDM-51SSB**

CABLE ASSEMBLY 13082831-509 WIRE LIST (cont)

FROM	TO	WIRE ID	WIRE SIZE
P8-1	P1-b3	171	24
P8-2	P8-120	212	26
P8-2	P8-128	211	26
P8-3	P1-M6	83	24
P8-4	P1-N1	83	24
P8-5	P1-V6	04	24
P8-6	P1-K2	65	24
P8-7	P3-R3	19	24
P8-8	P1-U6	121	24
P8-9	P2-a4	267	24
P8-10	P1-Y1	143	24
P8-11	P1-K5	67	24
P8-12	P2-K5	215	24
P8-14	P1-S6	104	24
P8-16	P1-V1	123	24
P8-17	P2-a5	268	24
P8-18	P1-X6	142	24
P8-19	P1-K3	65	24
P8-20	P1-K4	67	24
P8-21	P2-K4	215	24
P8-22	P1-T6	113	24
P8-23	P1-C6	20	24
P8-24	P2-c1	258	24
P8-25	P1-D2	22	24
P8-30	P1-U4	119	24
P8-33	P1-D1	20	24
P8-34	P3-S4	325	24
P8-35	P3-R2	319	24
P8-37	P1-B2	8	24
P8-42	P1-U5	119	24
P8-44	P2-c5	261	24
P8-45	P1-U1	115	24
P8-46	P3-P6	318	24
P8-47	P2-c4	261	24
P8-56	P3-L3	299	24
P8-57	P3-G1	283	24
P8-58	P1-B4	10	24
P8-70	P3-U2	154	24
P8-79	P1-D4	23	24
P8-80	P1-W4	133	24
P8-81	P1-D5	23	24

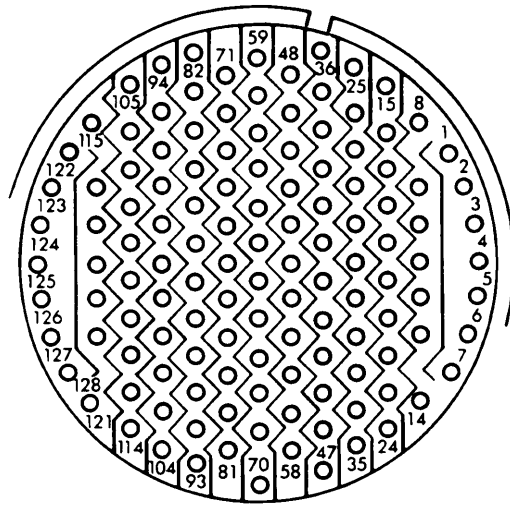

EL9LQ-1000-124

P8 - MS27467T25F35SA

3-32. TPS CABLE ASSEMBLIES (cont)

3-32

CABLE ASSEMBLY 13082831-509 WIRE LIST (cont)

FROM	TO	WIRE ID	WIRE SIZE
P8-90	P3-L4	300	24
P8-91	P3-V2	158	24
P8-92	P1-W2	130	26
P8-93	P1-B6	12	24
P8-94	P3-R5	320	24
P8-95	P3-L5	301	24
P8-96	P1-D6	24	24
P8-101	P3-G2	284	24
P8-102	P3-U2	155	24
P8-103	P1-C1	13	24
P8-104	P1-W2	131	26
P8-105	P3-R4	320	24
P8-106	P1-M2	79	24
P8-107	P1-E3	25	24
P8-108	P1-D3	22	24
P8-109	P8-110	214	26
P8-110	P8-109	214	26
P8-110	P8-120	213	26
P8-111	P1-W5	134	24
P8-112	P3-V2	159	24
P8-113	P3-S1	315	24
P8-114	P3-P1	315	24
P8-115	P1-M3	79	24
P8-116	P1-E1	24	24
P8-117	P3-L6	302	24
P8-118	P1-W6	135	24
P8-119	P3-G3	285	24
P8-120	P8-2	212	26
P8-120	P8-110	213	26
P8-121	P3-S6	326	24
P8-122	P1-E2	25	24
P8-123	P3-M1	303	24
P8-124	P3-G4	286	24
P8-125	P3-T6	327	24
P8-126	P3-G5	287	24
P8-127	P1-b1	167	24
P8-128	P2-K3	210	26
P8-128	P8-2	211	26
P9 OPEN	P1-STP7	26	SHLD
P9 OPEN	P1-STP8	29	SHLD
P9 OPEN	P1-STP9	31	SHLD

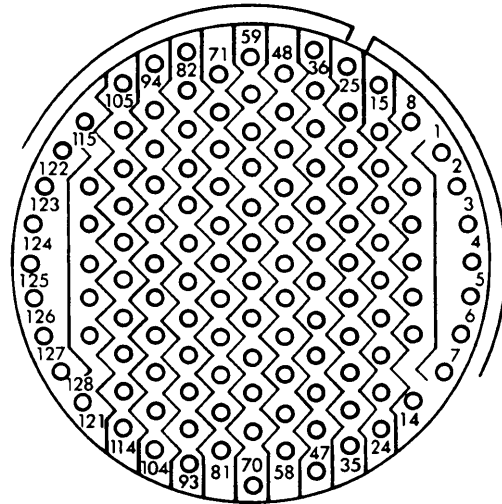

CABLE ASSEMBLY 13082831-509 WIRE LIST (cont)

FROM	TO	WIRE ID	WIRE SIZE	FROM	TO	WIRE ID	WIRE SIZE
P9 OPEN	P1-STP10	32	SHLD	P9-47	P2-S1	240	24
P9 OPEN	P1-STP11	35	SHLD	P9-50	P4-F7	345	24
P9 OPEN	P1-STP22	80	SHLD	P9-56	P2-b6	257	24
P9 OPEN	P1-STP29	140	24	P9-57	P2-S2	240	24
P9 OPEN	P1-STP34	175	SHLD	P9-58	SPL12	380	24
P9 OPEN	P2-STP40	240	SHLD	P9-61	P4-F8	345	24
P9 OPEN	P2-STP41	241	SHLD	P9-63	P1-V2	140	24
P9 OPEN	P2-STP42	249	SHLD	P9-64	P1-V4	140	24
P9 OPEN	P3-STP63	389	SHLD	P9-70	P2-S4	241	24
P9 OPEN	P4-STP51	342	SHLD	P9-76	P1-Z3	139	24
P9 OPEN	P4-STP52	343	SHLD	P9-77	P1-Z6	139	24
P9 OPEN	P4-STP53	344	SHLD	P9-79	P3-H1	288	24
P9 OPEN	P4-STP54	345	SHLD	P9-80	P1-c1	175	24
P9 OPEN	P4-STP55	346	SHLD	P9-81	P1-R1	92	24
P9 OPEN	P4-STP56	347	SHLD	P9-82	P2-D2	193	24
P9 OPEN	P4-STP57	348	SHLD	P9-90	P1-F1	29	24
P9-1	P4-A8	342	24	P9-91	P3-V4	389	24
P9-3	P4-H7	346	24	P9-92	P2-V3	194	24
P9-5	P2-B2	187	24	P9-93	P1-E6	29	24
P9-6	P4-C8	343	24	P9-94	P1-F2	31	24
P9-7	P2-S5	249	24	P9-95	P1-b6	175	24
P9-8	P4-C7	343	24	P9-96	P1-a5	165	24
P9-11	P4-H8	346	24	P9-102	P3-M3	305	24
P9-12	P2-B4	188	24	P9-103	P3-F4	151	24
P9-13	P2-T6	249	24	P9-104	P3-M4	306	24
P9-14	P2-B6	189	24	P9-105	P3-V3	389	24
P9-17	P4-A7	342	24	P9-106	P1-G1	35	24
P9-18	P1-a5	164	24	P9-107	P3-M5	307	24
P9-19	P1-E5	26	24	P9-108	P3-M6	308	24
P9-20	P2-C2	190	24	P9-109	P1-F3	31	24
P9-21	P3-M2	304	24	P9-110	P1-R4	96	24
P9-22	P2-S3	241	24	P9-111	P3-N1	309	24
P9-23	P4-M3	348	24	P9-112	P3-N2	310	24
P9-24	P1-E4	26	24	P9-113	P1-F4	32	24
P9-32	P4-K3	347	24	P9-114	P1-F5	32	24
P9-33	P4-M4	348	24	P9-115	P3-N3	311	24
P9-34	P4-D8	344	24	P9-116	P3-N4	312	24
P9-35	P4-K4	347	24	P9-117	P3-N5	313	24
P9-44	P2-C4	191	24	P9-118	P3-N6	314	24
P9-45	P4-D7	344	24	P9-119	P1-M5	80	24
P9-46	P2-C6	192	24	P9-120	SPL11	379	24
				P9-121	P3-A4	270	24
				P9-122	P3-A6	271	24
				P9-123	P2-D6	195	24
				P9-124	P1-F6	35	24

3-32. TPS CABLE ASSEMBLIES (cont)

3-32

CABLE ASSEMBLY 13082831-509 WIRE LIST (cont)

FROM	TO	WIRE ID	WIRE SIZE
P9-125	P3-B4	273	24
P9-126	P1-M4	80	24
P9-127	P1-T2	107	24
P9-128	P3-H2	289	24
P9-STP58	P3 OPEN	377	SHLD
P9-STP58	SPL14	377	SHLD
P10 OPEN	P1-STP14	43	SHLD
P10 OPEN	P1-STP17	75	SHLD
P10 OPEN	P1-STP18	76	SHLD
P10 OPEN	P1-STP19	77	SHLD
P10 OPEN	P1-STP20	78	SHLD
P10 OPEN	P1-STP24	87	SHLD
P10 OPEN	P1-STP25	88	SHLD
P10 OPEN	P1-STP26	89	SHLD
P10 OPEN	P1-STP27	90	SHLD
P10 OPEN	P2-STP35	203	SHLD
P10 OPEN	P2-STP36	204	SHLD
P10 OPEN	P2-STP37	205	SHLD
P10 OPEN	P2-STP39	230	SHLD
P10 OPEN	P3-STP46	316	SHLD
P10 OPEN	P3-STP47	317	SHLD
P10-1	P2-J5	204	24
P10-2	P3-C4	275	24
P10-3	P1-M1	78	24
P10-4	P3-C6	276	24
P10-5	P1-P1	88	24
P10-6	P3-D4	278	24
P10-7	P3-H3	290	24
P10-8	P2-N5	230	24
P10-9	P3-D6	279	24
P10-10	P3-H4	291	24
P10-11	P1-K6	75	24
P10-12	P1-L5	77	24
P10-13	P3-E4	281	24
P10-14	P1-N4	87	24
P10-16	P2-N6	230	24
P10-19	P1-L2	76	24
P10-20	P10-90	51	26
P10-20	P10-98	50	26

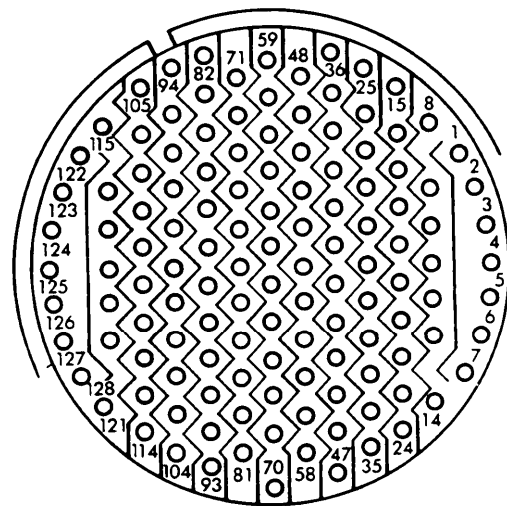

EL9LQ-1000-126

P10-MS24767T25F35SC

CABLE ASSEMBLY 13082831-509 WIRE LIST (cont)

FROM	TO	WIRE ID	WIRE SIZE	FROM	TO	WIRE ID	WIRE SIZE
P10-21	P1-L4	77	24	P10-101	P10-104	388	26
P10-22	P1-P3	89	24	P10-101	P10-128	387	26
P10-23	P2-b3	254	24	P10-102	P1-R3	94	24
P10-24	P2-P5	232	24	P10-103	P3-H6	384	26
P10-25	P2-J2	203	24	P10-103	P10-80	383	26
P10-29	P1-V5	127	24	P10-104	P10-91	390	26
P10-32	P2-J4	204	24	P10-104	P10-101	388	26
P10-33	P1-R4	95	24	P10-105	P10-93	60	26
P10-34	P1-L1	75	24	P10-105	P10-96	59	26
P10-35	P2-J3	203	24	P10-106	P1-J1	43	24
P10-44	P1-N5	87	24	P10-107	P1-S4	102	24
P10-45	P2-H2	205	24	P10-109	P3-P5	317	24
P10-46	P2-J6	205	24	P10-110	P1-P5	90	24
P10-47	P1-N6	88	24	P10-111	P10-93	61	26
P10-56	P1-P2	89	24	P10-111	P10-95	62	26
P10-57	P3-P3	316	24	P10-112	P1-b4	173	26
P10-58	P1-L3	76	24	P10-113	P1-R6	98	24
P10-62	P3-Y1	19	24	P10-113	P10-114	386	26
P10-63	P3-Y2	21	24	P10-114	P10-70	385	26
P10-70	P10-114	385	26	P10-114	P10-113	386	26
P10-79	P1-L6	78	24	P10-115	P1-P4	90	24
P10-80	P10-103	383	26	P10-116	P10-81	56	26
P10-81	P10-116	56	26	P10-116	P10-127	57	26
P10-81	P10-123	55	26	P10-117	P10-121	53	26
P10-89	P1-b4	172	26	P10-117	P10-123	54	26
P10-90	P10-20	51	26	P10-118	P1-J6	47	26
P10-90	P10-121	52	26	P10-118	P10-125	48	26
P10-91	P10-104	390	26	P10-119	P1-c4	179	24
P10-91	P10-120	391	26	P10-120	P1-W3	132	24
P10-92	P10-95	63	26	P10-120	P10-91	391	26
P10-93	P10-105	60	26	P10-121	P10-90	52	26
P10-93	P10-111	61	26	P10-121	P10-117	53	26
P10-94	P1-J2	43	24	P10-122	P1-R5	97	24
P10-95	P10-92	63	26	P10-123	P10-81	55	26
P10-95	P10-111	62	26	P10-123	P10-117	54	26
P10-96	P10-105	59	26	P10-124	P3-R1	317	24
P10-96	P10-127	58	26	P10-125	P10-98	49	26
P10-97	P1-b2	168	24	P10-125	P10-118	48	26
P10-98	P10-20	50	26	P10-126	P3-P4	316	24
P10-98	P10-125	49	26	P10-127	P10-96	58	26
P10-99	P1-b2	169	24	P10-127	P10-116	57	26
P10-100	P1-c3	178	24				



3-32. TPS CABLE ASSEMBLIES (cont)

3-32

CABLE ASSEMBLY 13082831-509 WIRE LIST (cont)

FROM	TO	WIRE ID	WIRE SIZE
P10-128	P10-101	387	26
P11-22	P3-K6	296	26
P11-25	P3-L1	297	26
P12-6	P3-F6	282	26
P12-27	P3-L2	298	26
P13-3	P2-L6	364	26
P13-4	P1-H4	367	26
P13-7	SPL9	354	26
P13-8	P1-G6	363	26
P13-11	P1-H2	365	26
P13-16	P1-T3	372	26
P13-18	P1-T1	373	26
P13-19	P1-J4	374	26
P13-20	P1-H5	368	26
P13-25	P1-H6	369	26
P13-28	P1-K1	366	26
P13-29	P2-X6	375	26
P13-33	P1-J3	370	26
P13-35	P2-M6	371	26
P13-36	P3-A2	354	26
P13-38	P3-B2	355	26
P13-40	P3-C2	356	26
P13-42	P3-D2	357	26
P13-44	P3-E2	358	26
P13-46	P2-H3	359	26
P13-48	P2-H4	360	26
P13-50	P2-H5	361	26
P13-51	P2-H6	362	26
SPL1	P1-STP1	18	SHLD
SPL1	P1-STP12	36	SHLD
SPL1	P1-STP13	37	SHLD
SPL1	P1-STP31	137	SHLD
SPL1	P1-STP32	138	SHLD
SPL1	SPL2	27	24
SPL2	P1-STP2	20	SHLD
SPL2	P1-STP3	22	SHLD
SPL2	P1-STP4	23	SHLD
SPL2	P1-STP5	24	SHLD
SPL2	P1-STP6	25	SHLD
SPL2	P1-STP15	65	SHLD
SPL2	SPL1	27	24

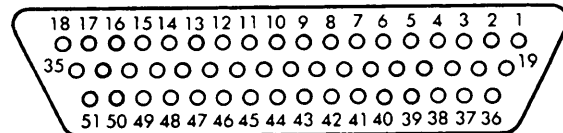

EL9LQ-1000-98

P11, P12 and P13-MDM-51SSB

CABLE ASSEMBLY 13082831-509 WIRE LIST (cont)

FROM	TO	WIRE ID	WIRE SIZE	FROM	TO	WIRE ID	WIRE SIZE
SPL2	SPL3	44	24	SPL7	SPL6	231	24
SPL3	P1-STP16	67	SHLD	SPL8	P3-F2	324	24
SPL3	P1-STP21	79	SHLD	SPL8	P3-STP45	315	SHLD
SPL3	P1-STP23	83	SHLD	SPL8	P3-STP46	316	SHLD
SPL3	P1-STP28	104	SHLD	SPL8	P3-STP47	317	SHLD
SPL3	P1-STP30	119	SHLD	SPL8	P3-STP48	319	SHLD
SPL3	SPL2	44	24	SPL8	P3-STP49	320	SHLD
SPL3	SPL4	81	24	SPL8	P3-STP50	323	SHLD
SPL4	P1-STP7	26	SHLD	SPL8	P3-STP62	382	SHLD
SPL4	P1-STP8	29	SHLD	SPL8	P3-STP63	394	SHLD
SPL4	P1-STP9	31	SHLD	SPL9	P2-M2	351	24
SPL4	P1-STP10	32	SHLD	SPL9	P7-7	353	S6
SPL4	P1-STP11	35	SHLD	SPL9	P7-13	352	26
SPL4	P1-STP22	80	SHLD	SPL9	P13-7	354	26
SPL4	P1-STP29	139	24	SPL10	P4-B7	349	24
SPL4	P1-STP33	140	SHLD	SPL10	P4-STP54	345	SHLD
SPL4	P1-STP34	175	SHLD	SPL10	P4-STP55	346	SHLD
SPL4	SPL3	81	24	SPL10	P4-STP56	347	SHLD
SPL4	SPL5	105	24	SPL10	P4-STP57	348	SHLD
SPL5	P1-H1	176	24	SPL10	P4-STP60	379	SHLD
SPL5	P1-H3	177	24	SPL11	P3-J3	378	24
SPL5	P1-STP14	43	SHLD	SPL11	P4-L3	379	24
SPL5	P1-STP17	75	SHLD	SPL11	P9-120	379	24
SPL5	P1-STP18	76	SHLD	SPL12	P3-J4	378	24
SPL5	P1-STP19	77	SHLD	SPL12	P4-L4	379	24
SPL5	P1-STP20	78	SHLD	SPL12	P9-58	380	24
SPL5	P1-STP24	87	SHLD	SPL13	P1-STP64	382	24
SPL5	P1-STP25	88	SHLD	SPL13	P1-STP61	381	SHLD
SPL5	P1-STP26	89	SHLD	SPL14	P4-STP59	377	SHLD
SPL5	P1-STP27	90	SHLD				
SPL5	SPL4	105	24				
SPL6	P2-STP35	203	SHLD				
SPL6	P2-STP36	204	SHLD				
SPL6	P2-STP37	205	SHLD				
SPL6	P2-STP38	215	SHLD				
SPL6	P2-STP39	230	SHLD				
SPL6	SPL7	231	24				
SPL7	P2-F2	262	24				
SPL7	P2-STP40	240	SHLD				
SPL7	P2-STP41	241	SHLD				
SPL7	P2-STP42	249	SHLD				
SPL7	P2-STP43	260	SHLD				
SPL7	P2-STP44	261	SHLD				

CABLE ASSEMBLY 13231735 WIRE LIST

FROM	TO	WIRE ID	WIRE SIZE
OPEN	P5 SHLD		
OPEN	P8 SHLD		
OPEN	P9 SHLD		
OPEN	P10 SHLD		
OPEN	P12 SHLD		
P1-A1	P10-7	1	24
P1-A2	P11-8	2	26
P1-A3	P11-14	3	26
P1-A4	P9-40	4	24
P1-A5	P9-6	5	24
P1-A6	P12-1	6	26
P1-B1	P12-2	8	26
P1-B2	P12-5	9	26
P1-B3	P12-6	10	26
P1-B4	P12-8	11	26
P1-B5	P12-9	12	26
P1-B6	P12-14	13	26
P1-C1	P12-21	14	26
P1-C2	P9-21	15	24
P1-C3	P9-30	16	24
P1-D1	P7-29	19	24
P1-D2	P10-16	20	24
P1-D3	P7-31	21	24
P1-D4	P10-43	22	24
P1-D5	P7-22	23	24
P1-D6	P10-36	24	24
P1-E1	P10-17	26	24
P1-E2	P10-18	27	24
P1-E3	P7-2	28	24
P1-E4	P10-25	29	24
P1-E5	P10-3	30	24
P1-E6	P6-10	31	24
P1-F1	P10-23	33	24
P1-F6	P7-14	34	24
P1-G1	P7-11	38	24
P1-H2	P9-47	41	24
P1-H4	P9-27	42	24
P1-H5	P9-44	43	24
P1-H6	P6-33	44	24
P1-J1	P10-41	47	24
P1-J2	P6-14	48	24

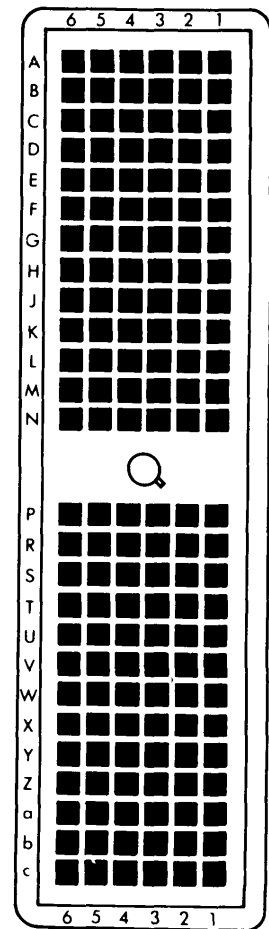

EL9LQ-1000-82A

P1-DL1-156P

CABLE ASSEMBLY 13231735 WIRE LIST (cont)

FROM	TO	WIRE ID	WIRE SIZE	FROM	TO	WIRE ID	WIRE SIZE
P1-J3	P10-5	49	24	P2-F6	P6-35	98	24
P1-J4	P6-16	50	24	P2-G5	P6-29	101	24
P1-J5	P6-9	51	24	P2-G6	P6-31	102	24
P1-J6	P9-64	52	24	P2-H2	P2-N3	108	24
P2 SHLD	STP1			P2-H2	P10-26	107	24
P2 SHLD	STP2			P2-H3	P9-50	212	24
P2 SHLD	STP3			P2-H4	P9-70	213	
P2 SHLD	STP4			P2-H5	P9-24	111	24
P2 SHLD	STP5			P2-H6	P9-11	112	24
P2 SHLD	STP6			P2-J1	P2-K6	146	24
P2-A1	P8-25	60	24	P2-J1	P2-N2	145	24
P2-A2	P12-22	61	26	P2-J2	P2-J3	115	24
P2-A3	P8-9	62	24	P2-J2	P10-74	114	24
P2-A4	P12-23	63	26	P2-J3	P2-J2	115	24
P2-A5	P8-36	64	24	P2-J3	P3-E6	363	24
P2-A6	P12-12	65	26	P2-J4	P3-D6	356	24
P2-B1	P10-6	67	24	P2-J4	P10-54	117	24
P2-B2	P12-13	68	26	P2-J5	P9-45	118	24
P2-B3	P11-28	69	26	P2-J6	P9-26	119	24
P2-B4	P12-24	70	26	P2-K1	P5-32	215	26
P2-B5	P9-63	71	24	P2-K2	P2-K5	139	24
P2-B6	P12-25	72	26	P2-K2	P2-N1	138	24
P2-C1	P11-15	75	26	P2-K3	P2-K4	122	24
P2-C2	P12-19	76	26	P2-K3	P10-69	121	24
P2-C3	P9-41	77	24	P2-K4	P2-K3	122	24
P2-C4	P7-17	78	24	P2-K4	P2-L1	123	24
P2-C5	P11-16	79	26	P2-K5	P2-K2	139	24
P2-C6	P8-17	80	24	P2-K6	P2-J1	146	24
P2-D1	P9-61	82	24	P2-L1	P2-K4	123	24
P2-D2	P11-26	83	26	P2-L2	P2-M1	129	24
P2-D3	P11-17	84	26	P2-L2	P10-73	128	24
P2-D4	P6-6	85	24	P2-L3	P10-29	221	24
P2-D5	P9-42	86	24	P2-L4	P10-9	222	
P2-D6	P6-28	87	24	P2-L5	P5-33	225	26
P2-E1	P11-18	89	26	P2-L6	P5-50	226	
P2-E2	SPL 2	228	24	P2-M1	P2-L2	129	24
P2-E3	P9-62	90	24	P2-M2	P6-21	131	24

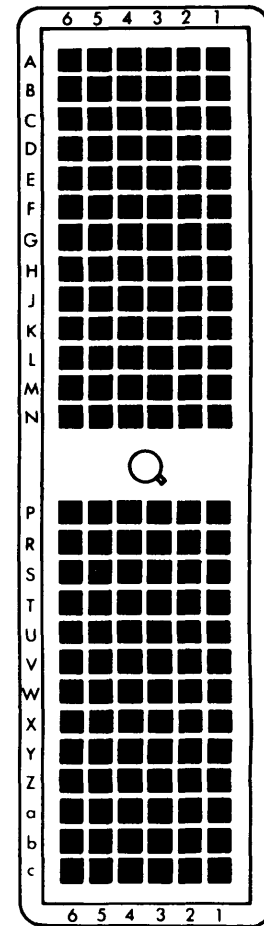

EL9LQ-1000-82A

P2-DL1-156P

3-32. TPS CABLE ASSEMBLIES (cont)

3-32

CABLE ASSEMBLY 13231735 WIRE LIST (cont)

FROM	TO	WIRE ID	WIRE SIZE	FROM	TO	WIRE ID	WIRE SIZE
P2-N1	P10-68	137	24	P2-Y6	P10-52	191	
P2-N2	P2-J1	145	24	P2-Z1	P8-38	196	24
P2-N2	P10-49	144	24	P2-Z2	P8-37	197	24
P2-N3	P2-H2	108	24	P2-Z3	P8-18	198	24
P2-N3	P2-W3	109	24	P2-Z4	P8-32	199	24
P2-N4	P2-U1	151	24	P2-Z5	P8-12	200	
P2-N4	P10-19	150	24	P2-Z6	P6-38	201	24
P2-N5	P2-U2	155	24	P2-a1	P8-15	204	24
P2-N5	P10-38	154	24	P2-a2	P8-35	205	24
P2-N6	P8-2	157	24	P2-a3	P8-29	206	24
P2-P6	P9-3	158	24	P2-a4	P8-31	207	24
P2-S5	P10-61	159	24	P2-a5	P10-27	208	24
P2-U1	P2-N4	151	24	P2-a6	P10-8	209	24
P2-U2	P2-N5	155	24	P3 SHLD	STP7		
P2-U3	P5-19	160	26	P3 SHLD	STP8		
P2-U4	P5-36	161	26	P3 SHLD	STP9		
P2-U5	P5-20	162	26	P3 SHLD	STP10		
P2-U6	P5-37	163	26	P3 SHLD	STP11		
P2-V1	P9-8	166	24	P3 SHLD	STP12		
P2-V2	P9-28	167	24	P3 SHLD	STP13		
P2-V3	P9-37	168	24	P3 SHLD	STP14		
P2-V4	P9-18	169	24	P3 SHLD	STP15		
P2-V5	P9-77	170	24	P3 SHLD	STP16		
P2-V6	P9-58	171	24	P3 SHLD	STP17		
P2-W1	P7-32	173	24	P3 SHLD	STP18		
P2-W2	P7-12	174	24	P3 SHLD	STP19		
P2-W3	P2-N3	109	24	P3 SHLD	STP20		
P2-W4	P9-60	175	24	P3 SHLD	STP21		
P2-W5	P6-4	176	24	P3 SHLD	STP22		
P2-W6	P8-4	177	24	P3 SHLD	STP23		
P2-X1	P10-53	179	24	P3 SHLD	STP24		
P2-X2	P10-71	180	24	P3 SHLD	STP25		
P2-X3	P10-51	181	24	P3-A2	P9-4	324	24
P2-X4	P7-38	182	24	P3-A4	P4-B	325	24
P2-X5	P7-37	183	24	P3-A6	P13-A	326	24
P2-X6	P7-18	184	24	P3-B2	P9-31	329	24
P2-Y1	P6-37	186	24	P3-B4	P4-A	330	24
P2-Y2	P6-18	187	24	P3-B6	P13-B	331	24
P2-Y3	P6-32	188	24	P3-C2	P9-25	346	24
P2-Y4	P6-12	189	24	P3-C4	P8-21	347	24
P2-Y5	P10-72	190	24	P3-C5	P8-33	348	24

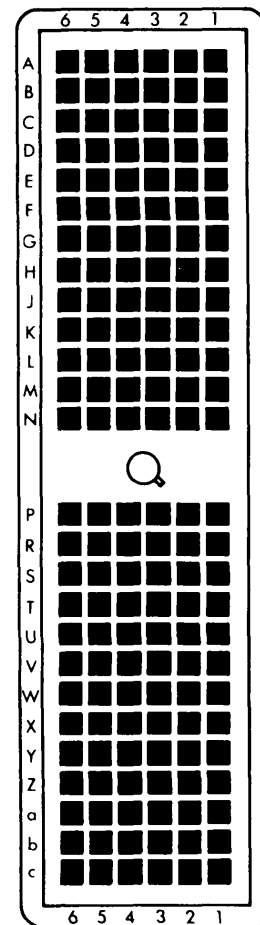

EL9LQ-1000-82A

P3-DL1-156P

## 3-32. TPS CABLE ASSEMBLIES (cont)

3-32

## CABLE ASSEMBLY 13231735 WIRE LIST (cont)

FROM	TO	WIRE ID	WIRE SIZE	FROM	TO	WIRE ID	WIRE SIZE
P3-C6	P10-28	349	26	P3-K4	P10-14	250	24
P3-D1	P10-62	351	24	P3-K5	P10-34	251	
P3-D2	P9-23	352	24	P3-K6	P10-35	409	
P3-D3	P8-22	353	24	P3-L1	P9-29	253	24
P3-D4	P8-1	354	24	P3-L2	P3-b1	243	24
P3-D5	P10-2	355	24	P3-L2	P9-57	241	24
P3-D6	P2-J4	356	24	P3-L3	P3-c1	246	24
P3-E1	P8-11	358	24	P3-L3	P9-76	242	
P3-E2	P9-1	359	24	P3-L4	P12-15	257	26
P3-E3	P10-22	360	24	P3-L5	P12-18	258	
P3-E4	P8-6	361	24	P3-L6	P10-12	415	
P3-E5	P8-30	362	24	P3-M1	P5-26	269	26
P3-E6	P2-J3	363	24	P3-M2	P5-48	270	26
P3-F1	P10-4	365	24	P3-M3	P5-47	271	
P3-F2	SPL5	384	24	P3-M4	P5-21	272	26
P3-F3	SPL6	402	24	P3-M5	P5-38	273	26
P3-F4	P8-28	366	24	P3-M6	P9-9	254	
P3-F6	P4-D	367	24	P3-N1	P5-25	283	26
P3-G1	P5-27	372	26	P3-N2	P5-42	284	26
P3-G2	P5-3	374	26	P3-N3	P5-49	285	26
P3-G3	P5-24	377	26	P3-N4	P5-41	275	26
P3-G4	P5-43	380	26	P3-N5	P5-29	276	
P3-G5	P5-23	383	26	P3-N6	P5-22	279	26
P3-G6	P9-17	386	24	P3-P1	P10-21	287	24
P3-H1	P3-a3	389	24	P3-P2	P6-30	288	24
P3-H1	P10-60	388	24	P3-P4	P7-33	289	24
P3-H2	P5-28	397	26	P3-P5	P6-22	290	24
P3-H3	P5-45	398	26	P3-R1	P10-1	293	24
P3-H4	P5-46	399	26	P3-R2	P6-11	294	24
P3-H5	P5-44	400	26	P3-R3	P7-13	295	24
P3-H6	P5-39	403	26	P3-R4	P7-27	296	24
P3-J1	P10-15	408	24	P3-R5	P8-14	297	24
P3-J2	P10-10	410	24	P3-S1	P10-42	299	24
P3-J3	P10-30	411		P3-S2	P7-30	300	24
P3-J4	P10-11	412	24	P3-S3	P10-37	301	24
P3-J5	P10-31	413		P3-S4	P7-10	302	24
P3-J6	P3-b5	419	24	P3-S5	P8-10	303	24
P3-J6	P10-40	418	24	P3-T1	P10-24	307	24
P3-K1	P10-13	414	24	P3-T3	P11-21	305	26
P3-K2	P10-39	238	24	P3-T5	P9-19	306	24
P3-K3	P10-20	239	24	P3-U1	P11-22	310	26

## 3-32. TPS CABLE ASSEMBLIES (cont)

3-32

## CABLE ASSEMBLY 13231735 WIRE LIST (cont)

FROM	TO	WIRE ID	WIRE SIZE	FROM	TO	WIRE ID	WIRE SIZE
P3-U2	SPL 4	281	24				
P3-U3	P9-39	311	24				
P3-U5	P11-23	312	26				
P3-U6	SPL 3	416	24				
P3-V1	P9-20	314	24				
P3-W1	P11-25	316	26				
P3-W2	P11-27	317	26				
P3-W3	P11-29	318	26				
P3-W4	P11-30	319	26				
P3-W5	P11-31	320	26				
P3-W6	P6-17	321	24				
P3-X1	P11-10	442	26				
P3-X2	P9-16	443	24				
P3-X3	P11-11	444	26				
P3-X4	P9-36	445	24				
P3-X5	P11-13	446	26				
P3-X6	P11-24	447	26				
P3-Y1	P11-6	449	26				
P3-Y2	P9-14	450	24				
P3-Y3	P11-7	451	26				
P3-Y4	P9-34	452	24				
P3-Y5	P11-9	453	26				
P3-Y6	P9-35	454	24				
P3-Z1	P11-2	456	26				
P3-Z2	P9-32	457	24				
P3-Z3	P11-4	458	26				
P3-Z4	P9-13	459	24				
P3-Z5	P11-5	460	26				
P3-Z6	P9-33	461	24				
P3-a1	P11-1	463	26				
P3-a2	P9-12	464	24				
P3-a3	P3-H1	389	24				
P3-a3	P3-a4	390	24				
P3-a4	P3-a3	390	24				
P3-a4	P3-a5	391	24				
P3-a5	P3-a4	391	24				
P3-a5	P3-a6	392	24				
P3-a6	P3-a5	392	24				
P3-a6	P3-b4	393	24				
P3-b1	P3-L2	243	24				
P3-b1	P3-b2	244	24				

CABLE ASSEMBLY 13231735 WIRE LIST (cont)

FROM	TO	WIRE ID	WIRE SIZE
P3-b2	P3-b1	244	24
P3-b2	P3-b3	245	24
P3-b3	P3-b2	245	24
P3-b4	P3-a6	393	24
P3-b5	P3-J6	419	24
P3-b5	P3-b6	420	24
P3-b6	P3-b5	420	24
P3-b6	P3-c4	421	24
P3-c1	P3-L3	246	24
P3-c1	P3-c2	247	24
P3-c2	P3-c1	247	24
P3-c2	P3-c3	248	24
P3-c3	P3-c2	248	24
P3-c4	P3-b6	421	24
P3-c4	P3-c5	422	24
P3-c5	P3-c4	422	24
P3-c5	P3-c6	423	24
P3-c6	P3-c5	423	24
P4-A	P3-B4	330	24
P4-B	P3-A4	325	24
P4-D	P3-F6	367	24
P5 SHLD	OPEN		
P5-3	P3-G2	374	26
P5-19	P2-U3	160	26
P5-20	P2-U5	162	26
P5-21	P3-M4	272	26
P5-22	P3-N6	279	26
P5-23	P3-G5	383	26
P5-24	P3-G3	377	26
P5-25	P3-N1	283	26
P5-26	P3-M1	269	26
P5-27	P3-G1	372	26
P5-28	P3-H2	397	26
P5-29	P3-N5	276	
P5-32	P2-K1	215	26
P5-33	P2-L5	225	26
P5-36	P2-U4	161	26
P5-37	P2-U6	163	26
P5-38	P3-M5	273	26
P5-39	P3-H6	403	26
P5-41	P3-N4	275	26

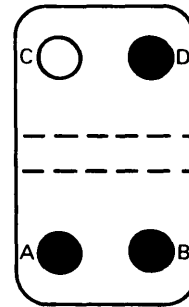

EL9LQ-1000-144

P4-SM-C-773505-1

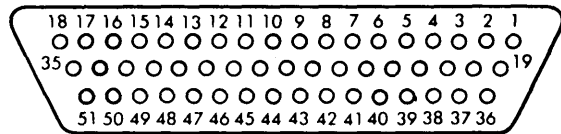

EL9LQ-1000-98

P5 - MDM-51SSB



3-32. TPS CABLE ASSEMBLIES (cont)

3-32

CABLE ASSEMBLY 13231735 WIRE LIST (cont)

FROM	TO	WIRE ID	WIRE SIZE
P5-42	P3-N2	284	26
P5-43	P3-G4	380	26
P5-44	P3-H5	400	26
P5-45	P3-H3	398	26
P5-46	P3-H4	399	26
P5-47	P3-M3	271	
P5-48	P3-M2	270	26
P5-49	P3-N3	285	26
P5-50	P2-L6	226	
P6-1	P2-M3	132	24
P6-2	P2-M4	133	24
P6-4	P2-W5	176	24
P6-6	P2-D4	85	24
P6-9	P1-J5	51	24
P6-10	P1-E6	31	24
P6-11	P3-R2	294	24
P6-12	P2-Y4	189	24
P6-14	P1-J2	48	24
P6-16	P1-J4	50	24
P6-17	P3-W6	321	24
P6-18	P2-Y2	187	24
P6-21	P2-M2	131	24
P6-22	P3-P5	290	24
P6-28	P2-D6	87	24
P6-29	P2-G5	101	24
P6-30	P3-P2	288	24
P6-31	P2-G6	102	24
P6-32	P2-Y3	188	24
P6-33	P1-H6	44	24
P6-34	P2-F5	97	24
P6-35	P2-F6	98	24
P6-37	P2-Y1	186	24
P6-38	P2-Z6	201	24
P7-1	P2-M6	135	24
P7-2	P1-E3	28	24
P7-10	P3-S4	302	24
P7-11	P1-G1	38	24
P7-12	P2-W2	174	24
P7-13	P3-R3	295	24
P7-14	P1-F6	34	24
P7-17	P2-C4	78	24

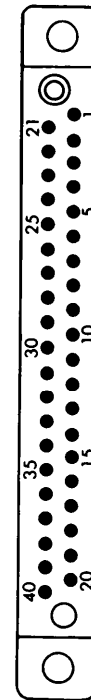

EL9LQ-1000-116

P6 and P7 - WTAV40PCJ

CABLE ASSEMBLY 13231735 WIRE LIST (cont)

FROM	TO	WIRE ID	WIRE SIZE
P7-18	P2-X6	184	24
P7-21	P2-M5	134	24
P7-22	P1-D5	23	24
P7-27	P3-R4	296	24
P7-29	P1-D1	19	24
P7-30	P3-S2	300	24
P7-31	P1-D3	21	24
P7-32	P2-W1	173	24
P7-33	P3-P4	289	24
P7-37	P2-X5	183	24
P7-38	P2-X4	182	24
P8 SHLD	OPEN		
P8-1	P3-D4	354	24
P8-2	P2-N6	157	24
P8-4	P2-W6	177	24
P8-6	P3-E4	361	24
P8-9	P2-A3	62	24
P8-10	P3-S5	303	24
P8-11	P3-E1	358	24
P8-12	P2-Z5	200	
P8-14	P3-R5	297	24
P8-15	P2-a1	204	24
P8-17	P2-C6	80	24
P8-18	P2-Z3	198	24
P8-21	P3-C4	347	24
P8-22	P3-D3	353	24
P8-25	P2-A1	60	24
P8-28	P3-F4	366	24
P8-29	P2-a3	206	24
P8-30	P3-E5	362	24
P8-31	P2-a4	207	24
P8-32	P2-Z4	199	24
P8-33	P3-C5	348	24
P8-35	P2-a2	205	24
P8-36	P2-A5	64	24
P8-37	P2-Z2	197	24
P8-38	P2-Z1	196	24
P9 SHLD	OPEN		
P9-1	P3-E2	359	24
P9-3	P2-P6	158	24
P9-4	P3-A2	324	24

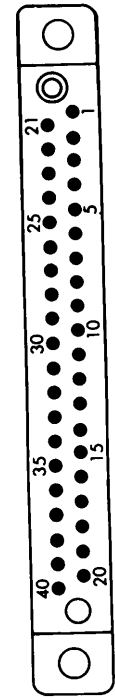

EL9LQ-1000-116

P8-WTAV40PCJ

CABLE ASSEMBLY 13231735 WIRE LIST (cont)

FROM	TO	WIRE ID	WIRE SIZE
P9-6	P1-A5	5	24
P9-8	P2-V1	166	24
P9-9	P3-M6	254	
P9-11	P2-H6	112	24
P9-12	P3-a2	464	24
P9-13	P3-Z4	459	24
P9-14	P3-Y2	450	24
P9-16	P3-X2	443	24
P9-17	P3-G6	386	24
P9-18	P2-V4	169	24
P9-19	P3-T5	306	24
P9-20	P3-V1	314	24
P9-21	P1-C2	15	24
P9-23	P3-D2	352	24
P9-24	P2-H5	111	24
P9-25	P3-C2	346	24
P9-26	P2-J6	119	24
P9-27	P1-H4	42	24
P9-28	P2-V2	167	24
P9-29	P3-L1	253	24
P9-30	P1-C3	16	24
P9-31	P3-B2	329	24
P9-32	P3-Z2	457	24
P9-33	P3-Z6	461	24
P9-34	P3-Y4	452	24
P9-35	P3-Y6	454	24
P9-36	P3-X4	445	24
P9-37	P2-V3	168	24
P9-38	P2-F1	95	24
P9-39	P3-U3	311	24
P9-40	P1-A4	4	24
P9-41	P2-C3	77	24
P9-42	P2-D5	86	24
P9-43	P2-F3	96	24
P9-44	P1-H5	43	24
P9-45	P2-J5	118	24
P9-47	P1-H2	41	24
P9-50	P2-H3	212	24
P9-57	P3-L2	241	24
P9-58	P2-V6	171	24
P9-60	P2-W4	175	24

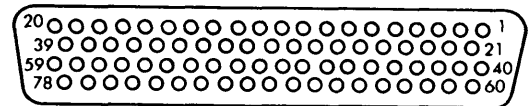

E19LQ-1000-69

P9-M24308/2-15

CABLE ASSEMBLY 13231735 WIRE LIST (cont)

FROM	TO	WIRE ID	WIRE SIZE
P9-61	P2-D1	82	24
P9-62	P2-E3	90	24
P9-63	P2-B5	71	24
P9-64	P1-J6	52	24
P9-70	P2-H4	213	
P9-76	P3-L3	242	
P9-77	P2-V5	170	24
P10 SHLD	OPEN		
P10-1	P3-R1	293	24
P10-2	P3-D5	355	24
P10-3	P1-E5	30	24
P10-4	P3-F1	365	24
P10-5	P1-J3	49	24
P10-6	P2-B1	67	24
P10-7	P1-A1	1	24
P10-8	P2-a6	209	24
P10-9	P2-L4	222	
P10-10	P3-J2	410	24
P10-11	P3-J4	412	24
P10-12	P3-L6	415	
P10-13	P3-K1	414	24
P10-14	P3-K4	250	24
P10-15	P3-J1	408	24
P10-16	P1-D2	20	24
P10-17	P1-E1	26	24
P10-18	P1-E2	27	24
P10-19	P2-N4	150	24
P10-20	P3-K3	239	24
P10-21	P3-P1	287	24
P10-22	P3-E3	360	24
P10-23	P1-F1	33	24
P10-24	P3-T1	307	24
P10-25	P1-E4	29	24
P10-26	P2-H2	107	24
P10-27	P2-a5	208	24
P10-28	P3-C6	349	26
P10-29	P2-L3	221	24
P10-30	P3-J3	411	
P10-31	P3-J5	413	
P10-34	P3-K5	251	
P10-35	P3-K6	409	

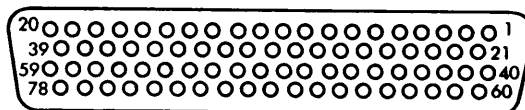

EL9LQ-1000-69

P10-M24308/2-15

3-32. TPS CABLE ASSEMBLIES (cont)

3-32

CABLE ASSEMBLY 13231735 WIRE LIST (cont)

FROM	TO	WIRE ID	WIRE SIZE	FROM	TO	WIRE ID	WIRE SIZE
P10-36	P1-D6	24	24				
P10-37	P3-S3	301	24				
P10-38	P2-N5	154	24				
P10-39	P3-K2	238	24				
P10-40	P3-J6	418	24				
P10-41	P1-J1	47	24				
P10-42	P3-S1	299	24				
P10-43	P1-D4	22	24				
P10-49	P2-N2	144	24				
P10-51	P2-X3	181	24				
P10-52	P2-Y6	191					
P10-53	P2-X1	179	24				
P10-54	P2-J4	117	24				
P10-60	P3-H1	388	24				
P10-61	P2-S5	159	24				
P10-62	P3-D1	351	24				
P10-68	P2-N1	137	24				
P10-69	P2-K3	121	24				
P10-71	P2-X2	180	24				
P10-72	P2-Y5	190	24				
P10-73	P2-L2	128	24				
P10-74	P2-J2	114	24				
P11-1	P3-a1	463	26				
P11-2	P3-Z1	456	26				
P11-4	P3-Z3	458	26				
P11-5	P3-Z5	460	26				
P11-6	P3-Y1	449	26				
P11-7	P3-Y3	451	26				
P11-8	P1-A2	2	26				
P11-9	P3-Y5	453	26				
P11-10	P3-X1	442	26				
P11-11	P3-X3	444	26				
P11-13	P3-X5	446	26				
P11-14	P1-A3	3	26				
P11-15	P2-C1	75	26				
P11-16	P2-C5	79	26				
P11-17	P2-D3	84	26				
P11-18	P2-E1	89	26				
P11-20	P2-E5	91	26				

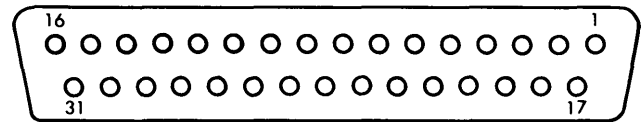

EL9LQ-1000-117

P11-MDM-31SSB

CABLE ASSEMBLY 13231735 WIRE LIST (cont)

FROM	TO	WIRE ID	WIRE SIZE
P11-21	P3-T3	305	26
P11-22	P3-U1	310	26
P11-23	P3-U5	312	26
P11-24	P3-X6	447	26
P11-25	P3-W1	316	26
P11-26	P2-D2	83	26
P11-27	P3-W2	317	26
P11-28	P2-B3	69	26
P11-29	P3-W3	318	26
P11-30	P3-W4	319	26
P11-31	P3-W5	320	26
P12 SHLD	OPEN		
P12-1	P1-A6	6	26
P12-2	P1-B1	8	26
P12-5	P1-B2	9	26
P12-6	P1-B3	10	26
P12-8	P1-B4	11	26
P12-9	P1-B5	12	26
P12-12	P2-A6	65	26
P12-13	P2-B2	68	26
P12-14	P1-B6	13	26
P12-15	P3-L4	257	26
P12-18	P3-L5	258	26
P12-19	P2-C2	76	26
P12-21	P1-C1	14	26
P12-22	P2-A2	61	26
P12-23	P2-A4	63	26
P12-24	P2-B4	70	26
P12-25	P2-B6	72	26
P13-A	P3-A6	326	24
P13-B	P3-B6	331	24
SPL1	P2-E4	214	24
SPL1	STP1		
SPL1	STP2		
SPL1	STP3		
SPL2	P2-E2	228	24
SPL2	STP4		
SPL2	STP5		
SPL2	STP6		
SPL3	P3-U6	416	24
SPL3	STP7		

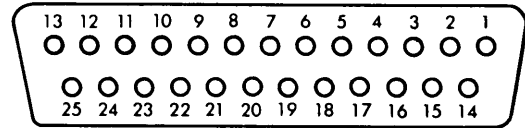

EL9LQ-1000-11

P12-MDM-25SSB

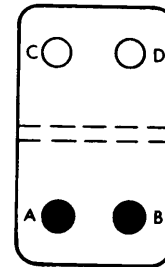

EL9LQ-1000-62A

P13-SM-C-773505-3

3-32. TPS CABLE ASSEMBLIES (cont)

3-32

CABLE ASSEMBLY 13231735 WIRE LIST (cont)

FROM	TO	WI RE I D	WI RE SI ZE	FROM	TO	WI RE I D	WI RE SI ZE
SPL3	STP22			STP11	P3 SHLD		
SPL3	STP23			STP11	SPL4		
SPL3	STP24			STP12	P3 SHLD		
SPL3	STP25			STP12	SPL4		
SPL4	P3- U2	281	24	STP13	P3 SHLD		
SPL4	STP8			STP13	SPL5		
SPL4	STP9			STP14	P3 SHLD		
SPL4	STP10			STP14	SPL5		
SPL4	STP11			STP15	P3 SHLD		
SPL4	STP12			STP15	SPL5		
SPL5	P3- F2	384	24	STP16	P3 SHLD		
SPL5	STP13			STP16	SPL5		
SPL5	STP14			STP17	P3 SHLD		
SPL5	STP15			STP17	SPL5		
SPL5	STP16			STP18	P3 SHLD		
SPL5	STP17			STP18	SPL6		
SPL6	P3- F3	402	24	STP19	P3 SHLD		
SPL6	STP18			STP19	SPL6		
SPL6	STP19			STP20	P3 SHLD		
SPL6	STP20			STP20	SPL6		
SPL6	STP21			STP21	P3 SHLD		
STP1	P2 SHLD			STP21	SPL6		
STP1	SPL1			STP22	P3 SHLD		
STP2	P2 SHLD			STP22	SPL3		
STP2	SPL1			STP23	P3 SHLD		
STP3	P2 SHLD			STP23	SPL3		
STP3	SPL1			STP24	P3 SHLD		
STP4	P2 SHLD			STP24	SPL3		
STP4	SPL2			STP25	P3 SHLD		
STP5	P2 SHLD			STP25	SPL3		
STP5	SPL2						
STP6	P2 SHLD						
STP6	SPL2						
STP7	P3 SHLD						
STP7	SPL3						
STP8	P3 SHLD						
STP8	SPL4						
STP9	P3 SHLD						
STP9	SPL4						
STP10	P3 SHLD						
STP10	SPL4						

CABLE ASSEMBLY 13231959 HIRE LIST

FROM	TO	WIRE ID	WIRE SIZE	FROM	TO	WIRE ID	WIRE SIZE
P1-H2	P3-30	1	22	P1-X3	P5-6	43	22
P1-H3	SPL 4	2	22	P1-X4	P5-7	44	22
P1-H5	SPL 1	3	22	P1-X5	P5-8	45	22
P1-H6	SPL 10	4	22	P1-X6	P5-9	46	22
P1-J1	SPL 5	5	22	P1-Y1	P3-28	47	22
P1-J2	SPL 5	6	22	P1-Y2	P3-29	48	22
P1-J3	P3-31	7	22	P1-Y4	P5-1	49	22
P1-J5	SPL 3	8	22	P1-Y5	P5-2	50	22
P1-J6	SPL 2	9	22	P1-Y6	P5-3	51	22
P1-K1	P5-31	10	22	P1-Z1	P3-22	52	22
P1-K2	P5-32	11	22	P1-Z2	P3-23	53	22
P1-K3	P5-33	12	22	P1-Z3	P3-24	54	22
P1-K4	P5-34	13	22	P1-Z4	SPL 4	55	22
P1-K5	P5-35	14	22	P1-Z5	P3-26	56	22
P1-K6	P5-36	15	22	P1-Z6	P3-27	57	22
P1-L1	P4-10	16	22	P1-a1	P3-13	58	22
P1-L2	P4-11	17	22	P1-a2	P3-14	59	22
P1-L3	P4-12	18	22	P1-a3	P3-15	60	22
P1-L4	P4-13	19	22	P1-a4	P3-19	61	22
P1-L5	P4-14	20	22	P1-a5	P3-20	62	22
P1-L6	P5-30	21	22	P1-a6	P3-21	63	22
P1-M1	P3-36	22	22	P2-A2	SPL 1	64	22
P1-M2	P3-37	23	22	P2-A4	P3-7	65	22
P1-M3	SPL 9	24	22	P2-A6	P3-1	66	22
P1-M4	SPL 10	25	22	P2-B2	SPL 9	67	22
P1-M5	P4-8	26	22	P2-B4	P3-8	68	22
P1-M6	P4-9	27	22	P2-B6	P3-2	69	22
P1-N1	SPL 6	28	22	P2-C2	SPL 3	70	22
P1-N2	SPL 6	29	22	P2-C4	P3-9	71	22
P1-N3	SPL 7	30	22	P2-C6	P3-3	72	22
P1-N4	SPL 7	31	22	P2-D2	SPL 2	73	22
P1-N5	SPL 8	32	22	P2-D4	P3-10	74	22
P1-N6	SPL 8	33	22	P2-D6	P3-4	75	22
P1-U3	P4-30	34	22	P2-E2	P5-37	76	22
P1-U4	P4-31	35	22	P2-E4	P3-11	77	22
P1-U5	P4-32	36	22	P2-E6	P3-5	78	22
P1-U6	P4-33	37	22	P2-F4	P3-12	79	22
P1-Y3	LUG	38	22	P2-F6	P3-6	80	22
P1-W1	P5-10	39	22	P2-G1	P4-24	81	22
P1-W2	P5-11	40	22	P2-G2	P4-25	82	22
P1-X1	P5-4	41	22	P2-G3	P4-26	83	22
P1-X2	P5-5	42	22	P2-G4	P4-27	84	22

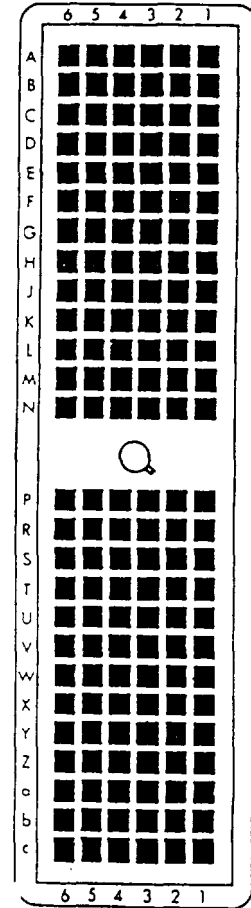

EL9LQ-1000-82A

P1 and P2 - DL1-156P



CABLE ASSEMBLY 13231959 WIRE LIST

FROM	TO	WIRE ID	WIRE SIZE	FROM	TO	WIRE ID	WIRE SIZE
P2-G5	P4-28	85	22	P3-32	SPL 5	127	22
P2-G6	P4-29	86	22	P3-33	SPL 6	128	22
P2-H1	P4-18	87	22	P3-34	SPL 7	129	22
P2-H2	P4-19	88	22	P3-35	SPL 8	130	22
P2-H3	P4-20	89	22	P4-6	SPL 9	131	22
P2-H4	P4-21	90	22	P4-7	SPL 10	132	22
P2-H5	P4-22	91	22	P1-W3	LUG	133	22
P2-H6	P4-23	92	22				
P2-J1	P4-3	93	22				
P2-J2	P4-4	94	22				
P2-J3	P4-5	95	22				
P2-J4	P4-15	96	22				
P2-J5	P4-16	97	22				
P2-J6	P4-17	98	22				
P2-K1	P5-26	99	22				
P2-K2	P5-27	100	22				
P2-K3	P5-28	101	22				
P2-K4	P5-29	102	22				
P2-K5	P4-1	103	22				
P2-K6	P4-2	104	22				
P2-L1	P5-20	105	22				
P2-L2	P5-21	106	22				
P2-L3	P5-22	107	22				
P2-L4	P5-23	108	22				
P2-L5	P5-24	109	22				
P2-L6	P5-25	110	22				
P2-M1	P5-14	111	22				
P2-M2	P5-15	112	22				
P2-M3	P5-16	113	22				
P2-M4	P5-17	114	22				
P2-M5	P5-18	115	22				
P2-M6	P5-19	116	22				
P2-N1	P4-34	117	22				
P2-N2	P4-35	118	22				
P2-N3	P4-36	119	22				
P2-N4	P4-37	120	22				
P2-N5	P5-12	121	22				
P2-N6	P5-13	122	22				
P3-16	SPL 1	123	22				
P3-17	SPL 2	124	22				
P3-18	SPL 3	125	22				
P3-25	SPL 4	126	22				

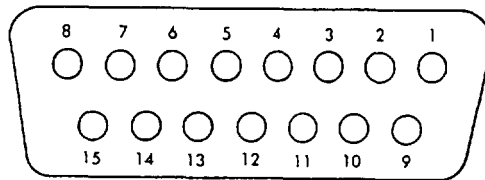

EL9LQ-1000-5

P3 - M24308/2-4F

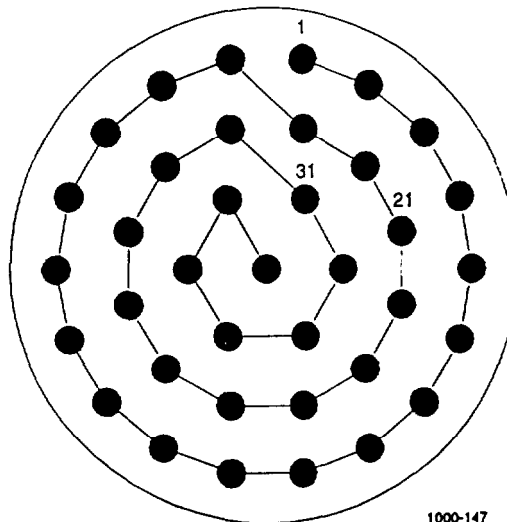

1000-147

P4 - D38999/24WD35SN

P5 - D38999/24WD35SA



3-33. SELF-TEST CONNECTORS

This task provides wiring data for the self-test connectors. These connectors are used with various TPSs as required by instructions displayed on the video display terminal (VDT). When performing continuity tests all resistance readings shall be a maximum of 1 ohm, except where otherwise indicated in the wire list. They are listed in numerical order according to part number.

	Page
Self-test Connector 13081705 Wire List . . . . .	3-567
Self-test Connector 13081894 Wire List . . . . .	3-569
Self-test Connector 13081998 Wire List . . . . .	3-573
Self-test Connector 13081998-79 Wire List . . . . .	3-575
Self-test Connector 13082458 Wire List . . . . .	3-578
Self-test Connector 13082467 Wire List . . . . .	3-579
Self-test Connector 13082471-379 Wire List . . . . .	3-593
Self-test Connector 13082514-39 Wire List . . . . .	3-599
Self-test Connector 13083091 Wire List . . . . .	3-602
Self-test Connector 13083091-19 Wire List . . . . .	3-603
Self-test Connector 13083679-29 Wire List . . . . .	3-604
Self-test Connector 13083679-39 Wire List . . . . .	3-604
Self-test Connector 13083679-49 Wire List . . . . .	3-604
Self-test Connector 13083961-29 Wire List . . . . .	3-605
Self-test Connector 13083962-39 Wire List . . . . .	3-606. 2
Self-test Connector 13083962-109 Wire List . . . . .	3-609
Self-test Connector 13083962-129 Wire List . . . . .	3-611
Self-test Connector 13083962-249 Wire List . . . . .	3-618
Self-test Connector 13083962-259 Wire List . . . . .	3-619
Self-test Connector 13083962-269 Wire List . . . . .	3-620
Self-test Connector 13083962-419 Wire List . . . . .	3-623
Self-test Connector 13083962-429 Wire List . . . . .	3-624
Self-test Connector 13083962-439 Wire List . . . . .	3-624
Self-test Connector 13083962-449 Wire List . . . . .	3-625
Self-test Connector 13083962-459 Wire List . . . . .	3-625
Self-test Connector 13083962-469 Wire List . . . . .	3-626
Self-test Connector 13083962-479 Wire List . . . . .	3-626
Self-test Connector 13083962-489 Wire List . . . . .	3-626. 1
Self-test Connector 13083962-499 Wire List . . . . .	3-626. 2

				Page
Sel f-test Connector	13083962-519	Wi re Li st	. . . . .	3-626.3
Sel f-test Connector	13083962-529	Wi re Li st	. . . . .	3-626.3
Sel f-test Connector	13083962-539	Wi re Li st	. . . . .	3-626.4
Sel f-test Connector	13083962-549	Wi re Li st	. . . . .	3-626.5
Sel f-test Connector	13083962-559	Wi re Li st	. . . . .	3-626.5
Sel f-test Connector	13083962-569	Wi re Li st	. . . . .	3-627
Sel f-test Connector	13083962-579	Wi re Li st	. . . . .	3-627
Sel f-test Connector	13083963-39	Wi re Li st	. . . . .	3-629
Sel f-test Connector	13083963-59	Wi re Li st	. . . . .	3-630
Sel f-test Connector	13083963-339	Wi re Li st	. . . . .	3-647
Sel f-test Connector	13083963-349	Wi re Li st	. . . . .	3-647
Sel f-test Connector	13083963-359	Wi re Li st	. . . . .	3-648
Sel f-test Connector	13083965-69	Wi re Li st	. . . . .	3-651
Sel f-test Connector	13083966	Wi re Li st	. . . . .	3-653
Sel f-test Connector	13083966-19	Wi re Li st	. . . . .	3-654
Sel f-test Connector	13083966-89	Wi re Li st	. . . . .	3-655
Sel f-test Connector	13083970	Wi re Li st	. . . . .	3-662
Sel f-test Connector	13083970-19	Wi re Li st	. . . . .	3-662
Sel f-test Connector	13083970-29	Wi re Li st	. . . . .	3-662

3-33. SELF-TEST CONNECTORS (cont)

				Page
Self-test Connector	13083972-19	Wire List	. . . . .	3-663
Self-test Connector	13083972-29	Wire List	. . . . .	3-664
Self-test Connector	13083972-39	Wire List	. . . . .	3-665
Self-test Connector	13231098	Wire List	. . . . .	3-666.1
Self-test Connector	13231518	Wire List	. . . . .	3-666.1
Self-test Connector	13231539	Wire List	. . . . .	3-666.1
Self-test Connector	13231685	Wire List	. . . . .	3-666.2
Self-test Connector	13231686	Wire List	. . . . .	3-666.2
Self-test Connector	13231699	Wire List	. . . . .	3-666.3
Self-test Connector	13231709	Wire List	. . . . .	3-666.3
Self-test Connector	13231710	Wire List	. . . . .	3-666.4
Self-test Connector	13231711	Wire List	. . . . .	3-666.4
Self-test Connector	13231712	Wire List	. . . . .	3-666.5
Self-test Connector	13231713	Wire List	. . . . .	3-666.5
Self-test Connector	13231730	Wire List	. . . . .	3-666.5
Self-test Connector	13231731	Wire List	. . . . .	3-666.6
Self-test Connector	13231732	Wire List	. . . . .	3-666.7
Self-test Connector	13231739	Wire List	. . . . .	3-666.8
Self-test Connector	13231756	Wire List	. . . . .	3-666.8
Self-test Connector	13231958	Wire List	. . . . .	3-666.9
Self-test Connector	13231963	Wire List	. . . . .	3-666.9



SELF-TEST CONNECTOR 13081705 WIRE LIST

FROM	TO	FROM	TO
A	B	G	H
B	C	H	J
C	D	J	K
D	E	K	L
E	F	L	M
F	G	M	N

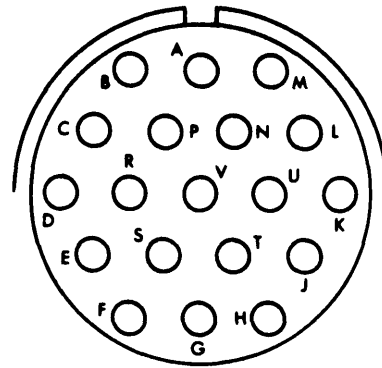

EL9LQ-1000-15  
DBC54H14-19SN





3-33. SELF-TEST CONNECTORS (cont)

3-33

SELF-TEST CONNECTOR 13081894 WIRE LIST

FROM	TO	FROM	TO
1	2	40	41
2	5	41	42
3	119	42	43
4	117	43	44
5	6	44	45
6	7	45	46
7	8	46	47
8	9	47	48
9	10	48	49
10	11	49	50
11	12	50	51
12	13	51	52
13	14	52	53
14	15	53	54
15	16	54	55
16	17	55	56
17	18	56	57
18	19	57	58
19	20	58	59
20	21	59	60
21	22	60	61
22	23	61	62
23	24	62	63
24	25	63	64
25	26	64	65
26	27	65	66
27	28	66	67
28	29	67	68
29	30	68	69
30	31	69	70
31	32	70	71
32	33	71	72
33	34	72	73
34	35	73	74
35	36	74	75
36	37	75	76
37	38	76	77
38	39	77	78
39	40	78	79

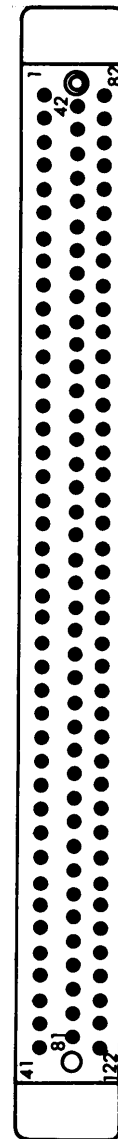

EL9LQ-1000-97

WGA122PR9J

SELF-TEST CONNECTOR 13081894 WIRE LIST (cont)

<u>FROM</u>	<u>TO</u>	<u>FROM</u>	<u>TO</u>
79	80	100	101
80	81	101	102
81	83	102	103
82	120	103	104
83	84	104	105
84	85	105	106
85	86	106	107
86	87	107	108
87	88	108	109
88	89	109	110
89	90	110	111
90	91	111	112
91	92	112	113
92	93	113	114
93	94	114	115
94	95	115	116
95	96	116	118
96	97	117	4
97	98	119	3
98	99	120	82
99	100	121	122

SELF-TEST CONNECTOR 13081998 WIRE LIST

FROM	TO	FROM	TO
1	2	26	27
2	3	27	28
3	4	28	29
4	5	29	30
5	6	30	31
6	7	31	32
7	8	32	33
8	9	33	34
9	10	34	35
10	11	35	36
11	12	36	37
12	13	37	38
13	14	38	39
14	15	39	40
15	16	40	41
16	17	41	42
17	18	42	43
18	19	43	44
19	20	44	45
20	21	45	46
21	22	46	47
22	23	47	48
23	24	48	49
24	25	49	50
25	26	50	51

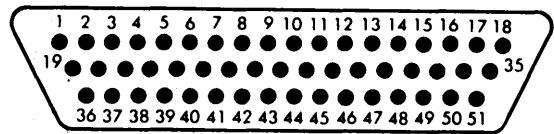

EL9LQ-1000-98

MDM-51PSA



3-33. SELF-TEST CONNECTORS (cont)

3-33

SELF-TEST CONNECTORU 13081998-79 WIRE LIST

FROM	TO	FROM	TO
3	4	22	28
5	6	22	50
7	29	23	39
8	31	25	26
9	18	27	28
10	11	30	49
12	40	32	42
13	24	33	35
14	15	34	38
16	21	41	49
17	44	43	48
19	37	45	47
20	36	46	50

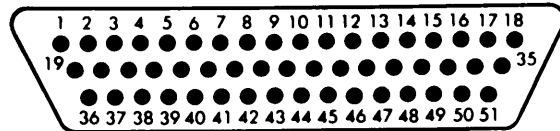

E19LQ-1000-98

MDM-51PSA





SELF-TEST CONNECTOR 13082458 WIRE LIST

FROM	TO	FROM	TO
1	2	6	7
2	3	8	9
4	5		

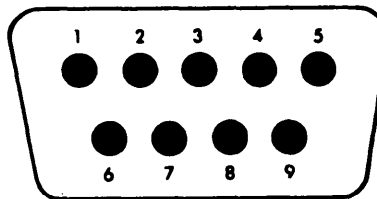

EL9LQ-1000-107

MDM-9PSP



3-33. SELF-TEST CONNECTORS (cont)

SELF-TEST CONNECTOR 13081998-79

FROM	TO	FROM	TO
P1-A	R1	P1-X	R3
P1-B	R4	R1	P1-A
P1-C	R5	R1	P1-N
P1-D	R6	R1	P1-X
P1-E	R2	R2	P1-E
P1-F	R7	R2	P1-N
P1-G	R8	R2	P1-X
P1-H	R9	R3	P1-J
P1-J	R3	R3	P1-N
P1-K	R10	R3	P1-X
P1-L	R11	R4	P1-B
P1-M	R12	R4	P1-W
P1-N	P1-X	R5	P1-C
P1-N	R1	R5	P1-W
P1-N	R2	R6	P1-D
P1-N	R3	R6	P1-W
P1-P	R13	R7	P1-F
P1-R	R14	R7	P1-V
P1-S	R15	R8	P1-G
P1-T	R13	R8	P1-V
P1-T	R14	R9	P1-H
P1-T	R15	R9	P1-V
P1-U	R10	R10	P1-K
P1-U	R11	R10	P1-U
P1-U	R12	R11	P1-L
P1-V	R7	R11	P1-U
P1-V	R8	R12	P1-M
P1-V	R9	R12	P1-U
P1-W	R4	R13	P1-P
P1-W	R5	R13	P1-T
P1-W	R6	R14	P1-R
P1-X	P1-N	R14	P1-T
P1-X	R1	R15	P1-S
P1-X	R2	R15	P1-T

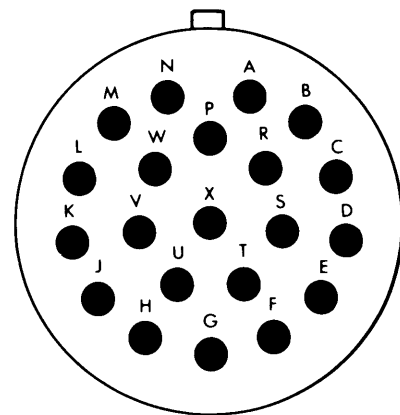

EL9LQ-1000-90

P1-PT06SE-22-21P(SR)



3-33. SELF-TEST CONNECTORS (cont)

3-33

SELF-TEST CONNECTOR 13082471-379

FROM	TO	FROM	TO
A1	B1	C15	D15
A2	B2	C16	D16
A3	B3	D1	C1
A4	B4	D2	C2
A5	B5	D3	C3
A6	B6	D4	C4
A7	B7	D5	C5
A8	B8	D6	C6
A9	B9	D7	C7
A10	B10	D8	C8
A11	B11	D9	C9
A12	B12	D10	C10
A13	B13	D11	C11
A14	B14	D12	C12
A15	B15	D13	C13
A16	B16	D14	C14
B1	A1	D15	C15
B2	A2	D16	C16
B3	A3		
B4	A4		
B5	A5		
B6	A6		
B7	A7		
B8	A8		
B9	A9		
B10	A10		
B11	A11		
B12	A12		
B13	A13		
B14	A14		
B15	A15		
B16	A16		
C1	D1		
C2	D2		
C3	D3		
C4	D4		
C5	D5		
C6	D6		
C7	D7		
C8	D8		
C9	D9		
C10	D10		
C11	D11		
C12	D12		
C13	D13		
C14	D14		

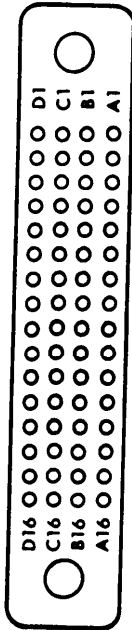

EL9LQ-1000-94A

104-064C



SELF-TEST CONNECTOR 13082514-39 WIRE LIST

FROM	TO
1	2
2	1
3	4
4	3
5	6
6	5
7	8
8	7
9	10
10	9
11	12
12	11
13	14
14	13
15	16
16	15
17	18
18	17
19	20
20	19
23	24
24	23

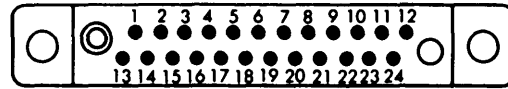

EL9LQ-1000-95

**M55302/63-A24M**

SELF-TEST CONNECTOR 13083091 WIRE LIST

FROM	TO	FROM	TO
A1	A3	X4	X3
A3	A1	X4	X5
N1	Y1	X5	X4
N3	X6	X5	X6
U1	U2	X6	X5
U2	U1	X6	N3
U2	U3	Y1	N1
U3	U2	Y1	Y2
U3	U4	Y2	Y1
U4	U3	Y2	Y3
U4	U5	Y3	Y2
U5	U4	Y3	Y4
U5	U6	Y4	Y3
U6	U5	Y4	Y5
U6	V1	Y5	Y4
V1	U6	Y5	Y6
V1	V2	Y6	Y5
V2	V1	Y6	Z1
V2	V3	Z1	Y6
V3	V2	Z1	Z2
V3	V4	Z2	Z1
V4	V3	Z2	Z3
V4	V5	Z3	Z2
V5	V4	Z3	Z4
V5	V6	Z4	Z3
V6	V5	Z4	Z5
V6	W1	Z5	Z4
W1	V6	Z5	Z6
W1	W2	Z6	Z5
W2	W1	Z6	a1
W2	W3	a1	a2
W3	W2	a1	Z6
W3	W4	a2	a1
W4	W3	a2	a3
W4	W5	a3	a2
W5	W4	a3	a4
W5	W6	a4	a3
W6	W5	a4	a5
W6	X1	a5	a4
X1	W6	a5	a6
X1	X2	a6	a5
X2	X1		
X2	X3		
X3	X2		
X3	X4		

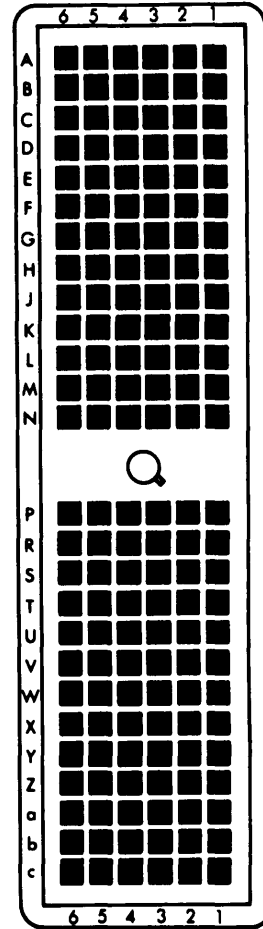

EL9LQ-1000-82A

DL1-156P

SELF-TEST CONNECTOR 13083091-19 WIRE LIST

FROM	TO	FROM	TO	FROM	TO
A2	G6	H3	H2	M1	L6
A4	F6	H3	H4	M1	M2
A4	B4	H4	H3	M2	M1
A6	B6	H4	H5	M2	M3
B2	M6	H5	H4	M3	M2
B4	A4	H5	H6	M3	M4
B4	C4	H6	H5	M4	M3
B6	A6	H6	J1	M4	M5
B6	C6	J1	H6	M5	M4
C2	N6	J1	J2	M5	M6
C4	B4	J2	J1	M6	M5
C4	D4	J2	J3	M6	B2
C5	D1	J3	J2	N1	N2
C6	B6	J3	J4	N2	N1
C6	D6	J4	J3	N2	N3
D1	C5	J4	J5	N3	N2
D2	F4	J5	J4	N3	N4
D4	C4	J5	J6	N4	N3
D4	E4	J6	J5	N4	N5
D6	C6	J6	K1	N5	N4
D6	E6	K1	J6	N5	N6
E4	D4	K1	K2	N6	N5
E4	F4	K2	K1	N6	C2
E6	D6	K2	K3		
E6	F6	K3	K2		
F4	E4	K3	K4		
F4	D2	K4	K3		
F6	E6	K4	K5		
F6	A4	K5	K4		
G1	G2	K5	K6		
G2	G1	K6	K5		
G2	G3	K6	L1		
G3	G2	L1	K6		
G3	G4	L1	L2		
G4	G3	L2	L1		
G4	G5	L2	L3		
G5	G4	L3	L4		
G5	G6	L4	L3		
G6	G5	L4	L5		
G6	A2	L5	L4		
H1	H2	L5	L6		
H2	H1	L6	L5		
H2	H3	L6	M1		

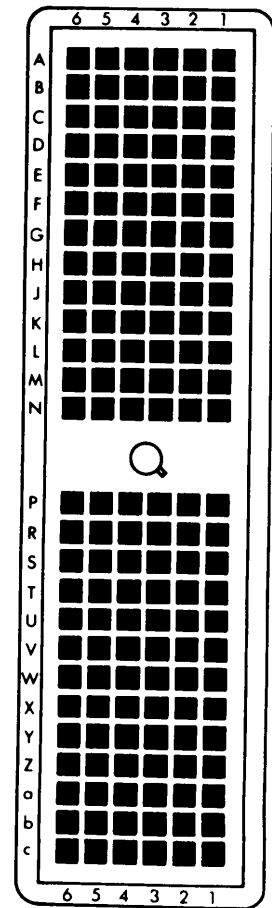

EL9LQ-1000-82A

DL1-156P

SELF-TEST CONNECTOR 13083679-29 WIRE LIST

FROM	TO
A	B
B	D
C	D

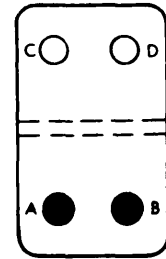

**JF2S2P45AB**

EL9LQ-1000-62 A

SELF-TEST CONNECTOR 13083679-39 WIRE LIST

FROM	TO
A	B
B	D
C	D

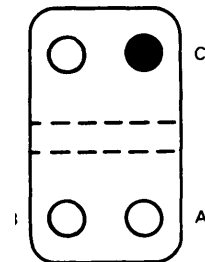

**JF3S1P45ABD**

EL9LQ-1000-143

SELF-TEST CONNECTOR 13083679-49 WIRE LIST

FROM	TO
A	B
B	D
C	D

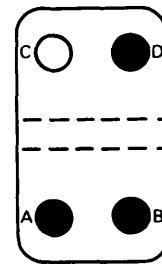

**JF3P1S45ABD**

EL9LQ-1000-144



SELF-TEST CONNECTOR 13083961-69 WIRE LIST

FROM	TO	FROM	TO
A	B	Y	Z
B	C	Z	a
C	D	a	b
D	E	b	c
E	F	c	d
F	G	d	e
G	H	e	f
H	J	f	g
J	K	g	h
K	L	h	k
L	M	k	m
M	N	m	n
N	P	n	p
P	R	p	q
R	S	q	r
S	T	r	s
T	U	s	t
U	V	t	u
V	W	u	v
W	X	v	w
X	Y	w	x

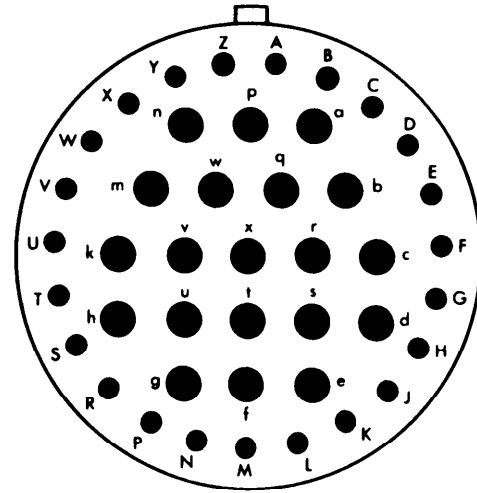

EL9LQ-1000-73

LJTOORE25-43P(014)





3-33. SELF-TEST CONNECTORS (cont)

SELF-TEST CONNECTOR 13083962-39 WIRE LIST

FROM	TO	FROM	TO
A	B (10K ohms)	E	F
C	D	F	G
D	E	G	H

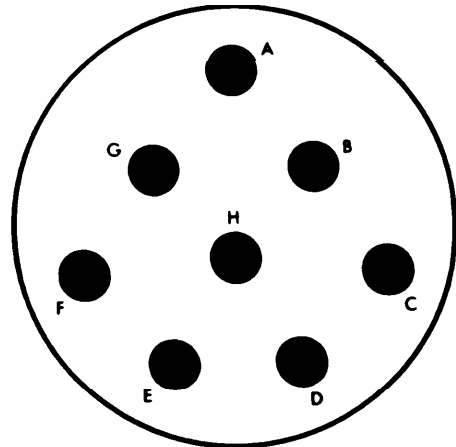

EL9LQ-1000-111A

LJTOORP17-8P(023)

3-33. SELF-TEST CONNECTORS (cont)

3-33

SELF-TEST CONNECTOR 13083962-109 WIRE LIST

FROM	TO	FROM	TO	FROM	TO
1	2	47	48	90	91
2	3	48	49	91	92
3	4	49	50	92	93
4	5	50	51	93	94
5	6	51	52	94	95
6	7	52	53	95	96
7	8	53	54	96	97
8	9	54	55	97	98
9	10	55	56	98	99
10	11	56	57	99	100
11	12	57	58	100	101
12	13	58	59	101	102
13	14	59	60	102	103
14	15	60	61	103	104
15	16	61	62	104	105
16	17	62	63	105	106
17	18	63	64	106	107
18	19	64	65	107	108
19	20	65	66	108	109
20	21	66	67	109	110
21	22	67	68	110	111
22	23	68	69	111	112
23	24	69	70	112	113
24	25	70	71	113	114
25	26	71	72	114	115
26	27	72	73	115	116
27	28	73	74	116	117
28	29	74	75	117	118
29	30	75	76	118	119
30	31	76	77	119	120
31	32	77	78	120	121
32	33	78	79	121	122
33	34	79	80	122	123
34	35	80	81	123	124
35	36	81	82	124	125
36	37	82	83	125	126
37	38	83	84	126	127
38	39	84	85	127	128
39	40	85	86		
40	41	86	87		
41	42	87	88		
42	43	88	89		
43	44	89	90		
44	45				
45	46				
46	47				

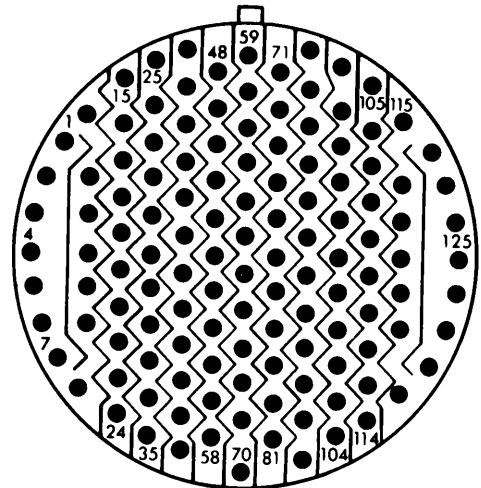

EL9LQ-1000-72A  
LJTOORP25-35P



SELF-TEST CONNECTOR 13083962-129 WIRE LIST

FROM	TO	FROM	TO
1	115	82	81
3	121	90	57
5	18	91	107
6	34	92	106
7	102	93	47
8	45	94	56
11	122	95	128
12	96	96	12
13	21	102	7
14	19	103	109
17	112	104	105
18	5	105	104
19	14	106	92
20	24	107	91
21	13	108	23
22	114	109	103
23	108	110	46
24	20	111	33
32	120	112	17
33	111	113	70
34	6	114	22
35	58	115	1
44	127	116	50
45	8	117	61
46	110	118	119
47	93	119	118
50	116	120	32
56	94	121	3
57	90	122	11
58	35	123	124
61	117	124	123
70	113	125	126
79	80	126	125
80	79	127	44
81	82	128	95

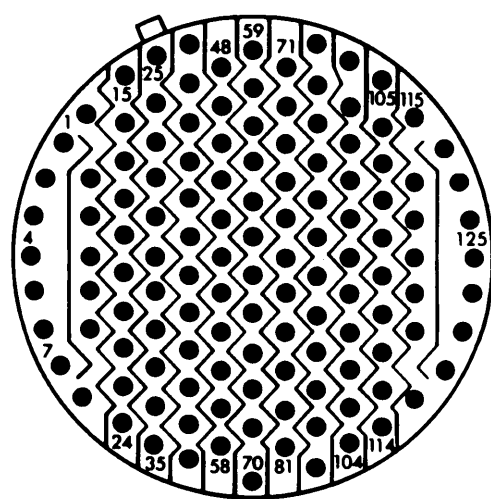

EL9LQ-1000-129

LJT00RP25-35PB







SELF-TEST CONNECTOR 13083962-249 WIRE LIST

FROM	TO	FROM	TO
1	37	92	81
3	115	93	114
9	35	94	72
10	11	95	105
11	10	96	116
14	50	102	103
15	16	103	102
16	15	104	121
17	36	105	95
24	47	106	123
27	38	107	122
35	9	109	83
36	17	110	125
37	1	111	61
38	27	114	93
47	24	115	3
50	14	116	96
56	69	117	82
61	111	120	127
69	56	121	104
72	94	122	107
81	92	123	106
82	117	125	110
83	109	127	120

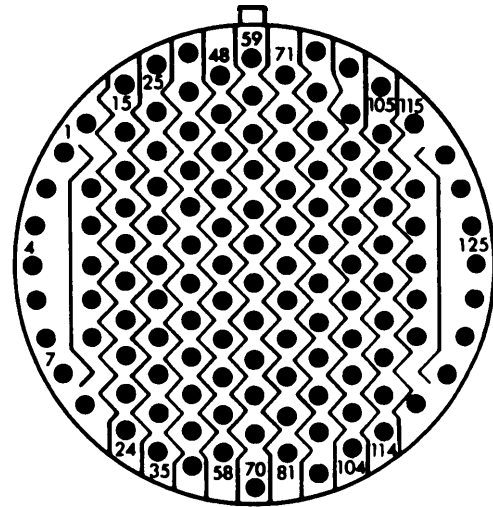

EL9LQ-1000-72A

LJTOORP25-35P

SELF-TEST CONNECTOR 13083962-259 WIRE LIST

FROM	TO	FROM	TO
1	2	68	35
2	1	69	33
5	105	70	34
6	123	71	94
8	9	73	82
9	8	82	73
13	22	83	49
14	57	84	105
17	25	84	125
22	13	93	104
25	17	94	71
26	55	95	96
27	48	96	95
33	69	103	113
34	70	104	93
35	68	105	5
36	38	105	84
37	59	106	115
38	36	107	117
47	55	113	103
48	27	115	106
49	83	116	122
55	26	117	107
55	47	122	116
57	14	123	6
59	37	124	61
61	124	125	84

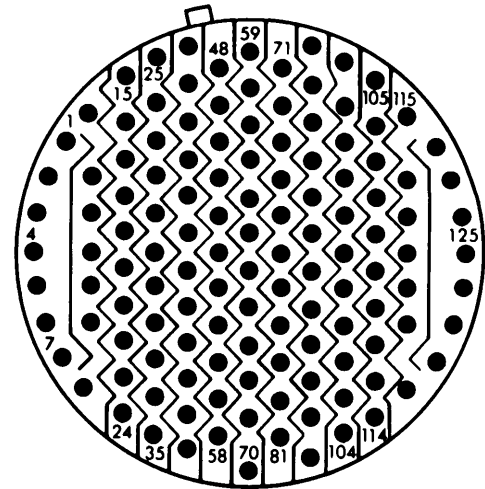

EL9LQ-1000-128

LJT00RP25-35PA

SELF-TEST CONNECTOR 13083962-269 WIRE LIST

FROM	TO	FROM	TO
A	r	e	T
B	J	f	H
C	m	g	JJ
D	s	h	R
G	LL	k	a
H	f	m	C
J	B	n	p
K	w	p	n
L	Z	q	M
M	q	r	A
N	AA	s	D
P	u	t	V
R	h	u	P
S	EE	v	Y
T	e	w	K
U	c	y	FF
V	t	z	b
W	X	AA	DD
X	w	AA	N
Y	v	DD	AA
Z	L	EE	S
a	k	FF	y
b	Z	JJ	g
c	U	LL	G

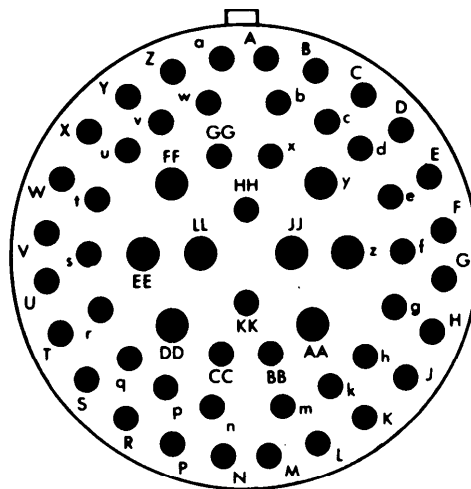

EL9LQ-1000-96

LJT00RP25-4P(014)

3-33. SELF-TEST CONNECTORS (cont)

3-33

SELF-TEST CONNECTOR 13083962-419 WIRE LIST

FROM	TO	FROM	TO	FROM	TO	FROM	TO
1	5	49	48	93	92	112	101
2	7	50	12	94	95	113	111
3	4	52	53	95	94	113	114
4	3	53	52	96	97	114	113
5	1	54	55	97	96	115	102
7	2	55	54	98	99	116	103
11	25	56	57	99	98	117	105
12	50	57	56	100	110	118	13
13	118	58	59	101	112	119	106
14	15	59	58	102	115	120	107
15	14	60	61	103	116	121	122
16	17	61	60	104	29	122	121
17	16	62	63	105	117	123	108
18	22	63	62	106	119	124	125
19	23	64	65	107	120	125	124
20	24	65	64	108	123	126	127
21	28	66	67	110	100	127	126
22	18	67	66	111	113	128	26
23	19	68	69				
24	20	69	68				
25	11	70	71				
26	128	71	70				
26	27	72	73				
27	26	73	72				
28	21	74	75				
29	104	75	74				
30	31	76	77				
31	30	77	76				
33	34	78	79				
34	33	79	78				
36	37	80	81				
37	36	81	80				
38	39	82	83				
39	38	83	82				
40	41	84	85				
41	40	85	84				
42	43	86	87				
43	42	87	86				
44	45	88	89				
45	44	89	88				
46	47	90	91				
47	46	91	90				
48	49	92	93				

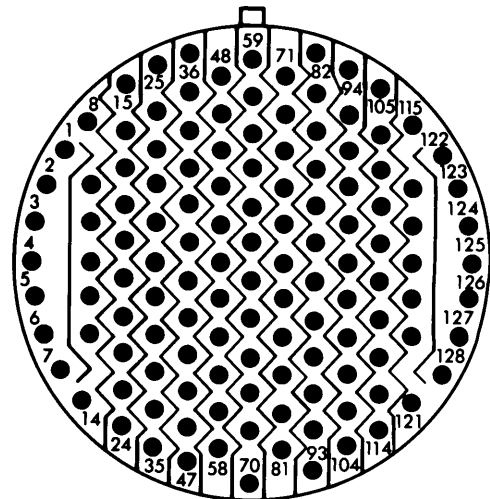

EL9LQ-1000-2

MS27656T25F35P

3-33. SELF-TEST CONNECTORS (cont)

SELF-TEST CONNECTOR 13083962-429 WIRE LIST

FROM	TO	FROM	TO
A	B	C	D
B	C	E	F

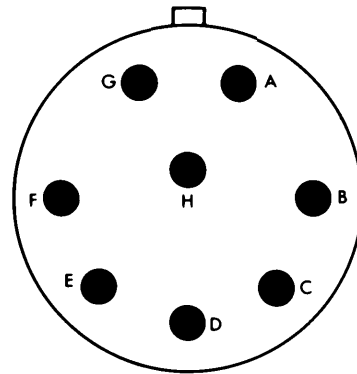

EL9LQ-1000-76

**MS27656T13F8P**

SELF-TEST CONNECTOR 13083962-439 WIRE LIST

FROM	TO
A	B (205 ohms)
A	C
A	A SHLD (10K ohms)
A SHLD	B SHLD
A SHLD	C SHLD
B	C (205 ohms)
B	B SHLD (10205 ohms)
B SHLD	C SHLD
C	C SHLD (10K ohms)

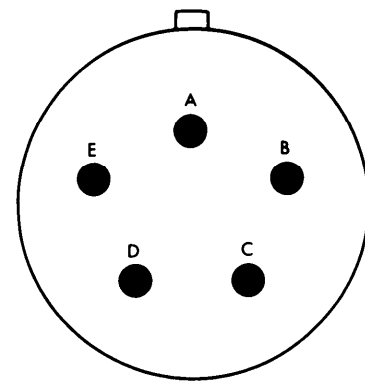

EL9LQ-1000-18

**MS27656T15F5P**

3-33. SELF-TEST CONNECTORS (cont)

3-33

SELF-TEST CONNECTOR 13083962-449 WIRE LIST

FROM	TO	FROM	TO
1	24	15	17
2	7	16	21
2	8	17	15
3	20	18	19
4	22	18	20
5	30	19	18
6	12	20	3
7	2	20	18
8	2	21	16
8	11	21	30
10	31	22	4
11	8	23	11
11	23	24	1
12	6	30	5
14	15	30	21
15	14	31	10

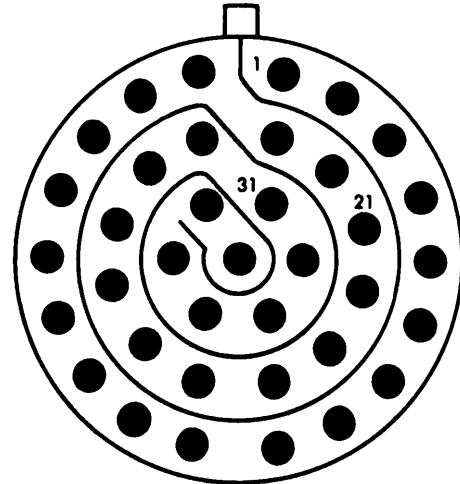

EL9LQ-1000-86

**MS27656T15F35P**

SELF-TEST CONNECTOR 13083962-459 WIRE LIST

FROM	TO
A	B
B	C
C	D
E	F

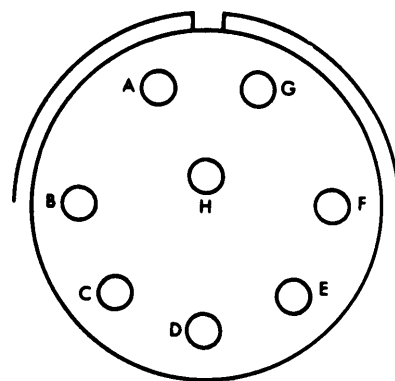

EL9LQ-1000-76

**MS27468T13F8S**

3-33. SELF-TEST CONNECTORS (cont)

SELF-TEST CONNECTOR 13083962-469 WIRE LIST

FROM	TO	FROM	TO
A	B	U	R
B	A	U	k
C	D	V	K
D	C	V	Y
E	F	V	T
F	E	X	Z
G	H	X	V
H	G	Y	X
H	K	Z	a
K	H	Z	Z
K	V	a	d
L	M	a	a
M	L	d	d
M	P	g	h
P	M	h	k
P	T	k	K
R	U	K	d (SHLD)
T	P	m	d
T	X	d (SHLD)	k

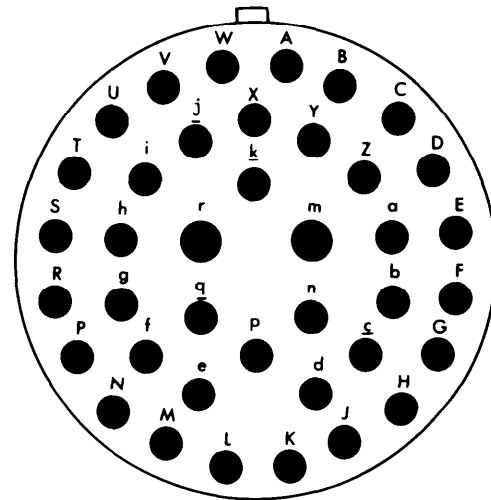

EL9LQ-1000-42A

MS27468T21F39P

SELF-TEST CONNECTOR 13083962-479 WIRE LIST

FROM	TO	FROM	TO
1	2	21	20
2	1	23	24
3	4	24	23
4	3	25	27
4	6	27	25
6	4	28	30
6	12	30	28
10	19	31	11
11	31	31	32
12	6	32	31
12	16	32	34
16	12	34	32
19	10	34	36
20	21	36	34

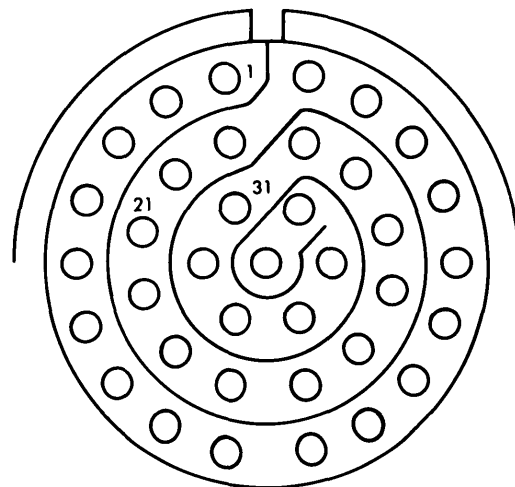

EL9LQ-1000-86

MS27468T15F35S



3-33. SELF-TEST CONNECTORS (cont)

3-33

SELF-TEST CONNECTOR 13083962-489 WIRE LIST

FROM	TO	FROM	TO
1	2	40	41
2	3	41	42
3	4	42	43
4	5	43	44
5	6	44	45
6	7	45	46
7	8	46	47
8	9	47	48
9	10	48	49
10	11	49	50
11	12	50	51
12	13	51	52
13	14	52	53
14	15	54	55
15	16	56	57
16	17	57	58
17	18	58	59
18	19	59	60
19	20	60	61
20	21	61	62
21	22	62	63
22	23	63	64
23	24	64	65
24	25	65	66
25	26	66	67
26	27	67	68
27	28	68	69
28	29	69	70
29	30	70	71
30	31	71	72
31	32	72	73
32	33	73	74
33	34	74	75
34	35	75	76
35	36	76	77
36	37	77	78
38	39	78	79

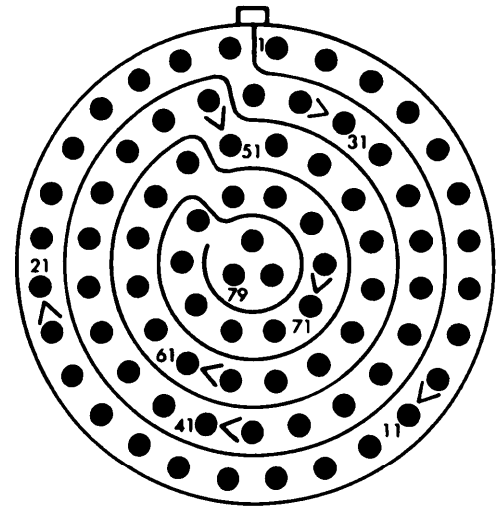

EL9LQ-1000-74

L1TOORP21-35P(014)

SELF-TEST CONNECTOR 13083962-499 WIRE LIST

FROM	TO
1	3
2	4
3	1
4	2

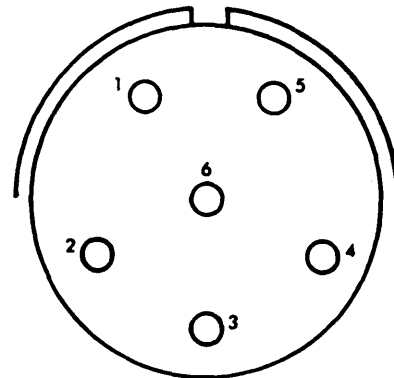

EL9LQ-1000-91

LJTOORP9-35S (014)

3-33. SELF-TEST CONNECTORS (cont)

3-33

SELF-TEST CONNECTOR 13083962-519 WIRE LIST

FROM	TO	FROM	TO
A	C	T	R
B	D	U	V
C	A	V	U
D	B	W	X
E	G	X	W
F	K	Y	N
G	E	Z	h
H	L	a	g
J	S	b	c
K	F	c	b
L	H	d	e
M	M	e	d
N	L	g	a
R	Y	h	Z
S	J	m	m SHLD
		m SHLD	m

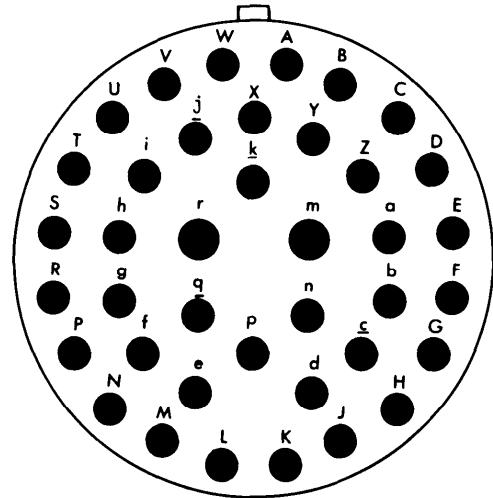

EL9LQ-1000-42A

MS27656T21F39P

SELF-TEST CONNECTOR 13083962-529 WIRE LIST

FROM	TO	FROM	TO
A	B	U	e
B	A	V	b
C	J	W	D
D	W	X	T
E	F	Y	Z
F	E	Z	S
G	H	a	X
H	G	a	a
H	m SHLD	b	m
J	C	c	v
K	K	d	h
L	M	e	g
M	L	e	U
N	L	g	d
P	N	h	c
R	T	k	K
S	R	m	a
T	X	m SHLD	H

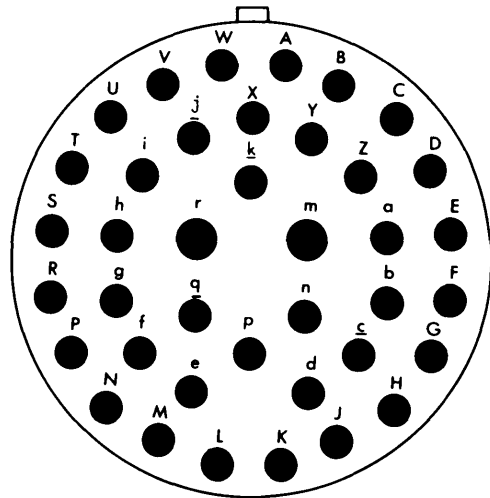

EL9LQ-1000-42A

MS27656T21F39P

3-33. SELF-TEST CONNECTORS (cont)

SELF-TEST CONNECTOR 13083962-539 WIRE LIST

FROM	TO	FROM	TO
1	10	31	30
2	8	32	29
3	4	33	25
4	3	34	18
4	7	34	56
5	12	35	26
6	11	38	27
7	4	49	28
8	2	50	67
9	17	51	66
10	1	55	19
11	6	56	34
12	5	62	63
13	15	63	62
15	13	63	64
16	22	64	63
17	9	64	65
18	34	65	64
19	55	66	51
20	72	67	50
21	99	67	100
22	16	70	24
23	71	71	23
24	70	72	20
25	33	73	98
26	35	74	75
27	38	75	74
28	49	98	73
29	32	99	21
30	31	100	67

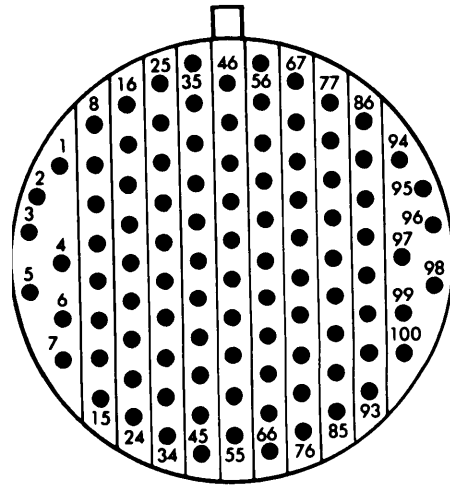

EL9LQ-1000-51

MS27656T23F35P

3-33. SELF-TEST CONNECTORS (cont)

3-33

SELF-TEST CONNECTOR 13083962-549 WIRE LIST

FROM	TO
4	11
6	10
10	6
10	28
11	4
25	27
27	25
28	10
28	30
30	28
31	32

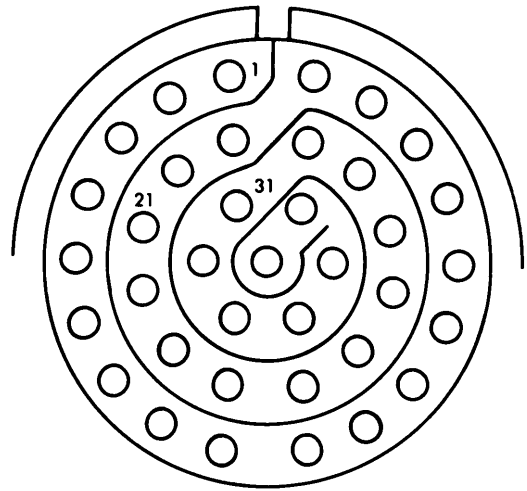

EL9LQ-1000-86

**MS27656T15F35S**

SELF-TEST CONNECTOR 13083962-559 WIRE LIST

FROM	TO	FROM	TO
1	24	15	3
2	23	16	10
3	15	17	14
4	18	18	4
5	8	19	22
6	7	20	21
7	6	21	20
8	5	22	19
10	16	23	2
11	31	24	1
12	30	30	12
14	17	31	11

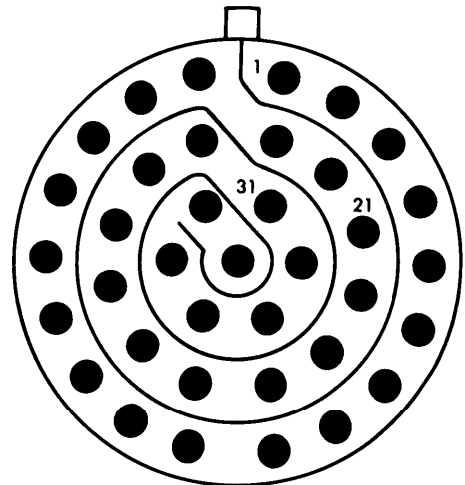

EL9LQ-1000-86

**MS27656T15F35P**



3-33. SELF-TEST CONNECTORS (cont)

3-33

SELF-TEST CONNECTOR 13083962-569 WIRE LIST

FROM	TO
E	W
G	m SHLD
K	L
L	K
M	X
R	T
T	R
T	Z
W	E
X	M
Z	T
Z	a
a	Z
a	m
m	a
m SHLD	G

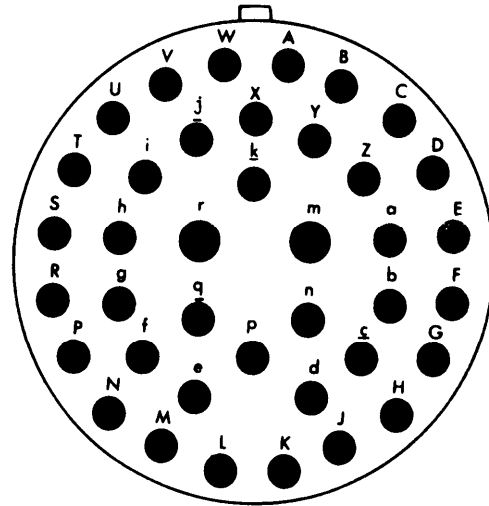

EL9LQ-1000-42A

**MS27656T21F39P**

SELF-TEST CONNECTOR 13083962-579 WIRE LIST

FROM	TO
P1-A	P1-H (1K ohms)
P1-B	P1-G (1K ohms)
P1-C	P1-F (1K ohms)
P1-D	P1-E (1K ohms)

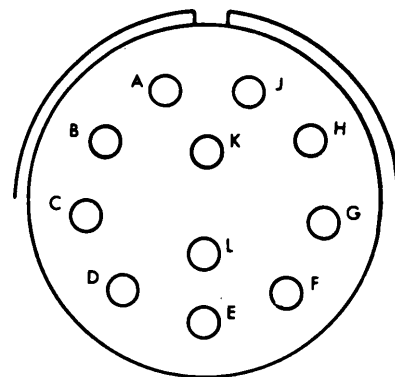

EL9LQ-1000-48

**MS3474L18-11S**





3-33. SELF-TEST CONNECTORS (cont)

3-33

SELF-TEST CONNECTOR 13083963-39 WIRE LIST

FROM	TO	FROM	TO	FROM	TO
1	2	13	14	25	26
2	3	14	15	26	27
3	5	15	16	27	28
4	30	16	17	28	29
5	6	17	18	29	31
6	7	18	19	31	32
7	8	19	20	32	33
8	9	20	21	33	34
9	10	21	22	34	35
10	11	22	23	35	36
11	12	23	24	36	37
12	13	24	25		

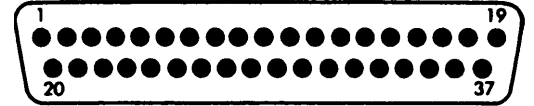

EL9LQ-1000-68

M24308/4-4

SELF-TEST CONNECTOR 13083963-59 WIRE LIST

FROM	TO	FROM	TO
1	2	40	41
2	3	41	42
3	4	42	43
4	5	43	44
5	6	44	45
6	7	45	46
7	8	46	47
8	9	47	48
9	10	48	49
10	11	49	50
11	12	50	51
12	13	51	52
13	14	52	53
14	15	53	54
15	16	54	55
16	17	55	56
17	18	56	57
18	19	57	58
19	20	58	59
20	21	59	60
21	22	60	61
22	23	61	62
23	24	62	63
24	25	63	64
25	26	64	65
26	27	65	66
27	28	66	67
28	29	67	68
29	30	68	69
30	31	69	70
31	32	70	71
32	33	71	72
33	34	72	73
34	35	73	74
35	36	74	75
36	37	75	76
37	38	76	77
38	39	77	78
39	40		

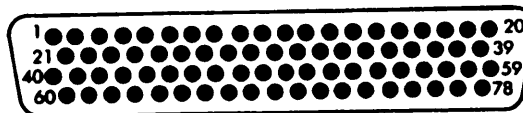

EL9LQ-1000-69

M24308/4-15

3-33. SELF-TEST CONNECTORS (cont)

3-33

SELF-TEST CONNECTOR 13083963-339 WIRE LIST

FROM	TO	FROM	TO
1	2	5	6
2	3	6	7
3	4	7	8
4	5	8	9

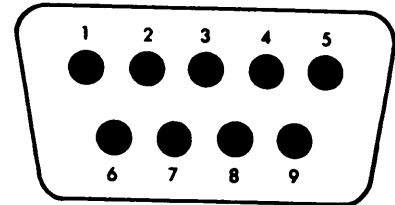

EL9LQ-1000-10

M24308/4-1

SELF-TEST CONNECTOR 13083963-349 WIRE LIST

FROM	TO	FROM	TO
1	12	31	38
2	10	34	20
2	75	35	39
3	77	36	62
4	24	36	78
4	51	37	48
5	61	37	57
6	25	41	28
6	59	41	40
7	47	42	15
7	58	44	18
8	30	46	10
9	19	47	69
13	14	52	13
16	18	53	31
21	11	55	56
21	45	63	34
22	17	64	33
23	3	66	35
23	50	67	74
26	54	70	60
27	32	71	14
29	43	76	68
29	49		

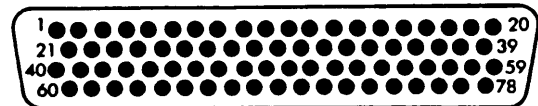

EL9LQ-1000-69

M24308/4-15

SELF-TEST CONNECTOR 13083963-359 WIRE LIST

FROM	TO
1	2
3	4
5	6
7	8
8	9

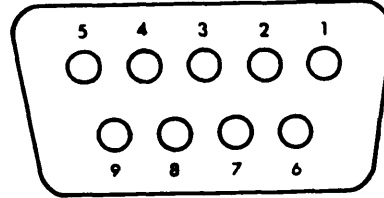

EL9LQ-1000-10

M24308/2-1

SELF-TEST CONNECTOR 13083965-69 WIRE LIST

FROM	TO
20	21
21	20
21	22
22	21
23	25
24	25
25	23
25	24
26	27
27	26
28	29
29	28
30	31
31	30
32	33
33	32
34	35
35	34
36	37
37	36

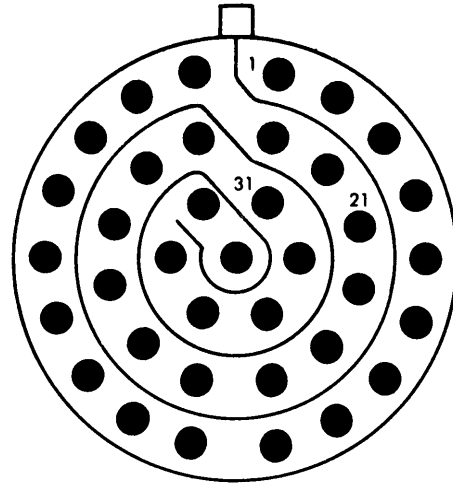

EL9LQ-1000-86

MS27467P15F35P



3-33. SELF-TEST CONNECTORS (cont)

3-33

SELF-TEST CONNECTOR 13083966 WIRE LIST

FROM	TO	FROM	TO
1	2	13	14
2	3	14	15
3	4	15	16
4	5	16	17
5	6	17	18
6	7	18	19
7	8	19	20
8	9	20	21
9	10	21	22
10	11	22	23
11	12	23	24
12	13	24	25

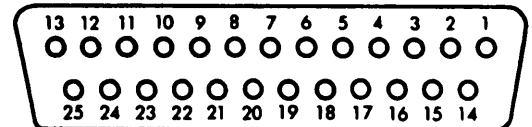

EL9LQ-1000-106

MDM-25SSP

SELF-TEST CONNECTOR 13083966-19 WIRE LIST

FROM	TO	FROM	TO
1	9	16	17
3	24	17	19
4	21	18	20
5	23	20	26
6	8	21	33
7	13 (20K ohms)	24	40
7	29 (10K ohms)	25	35
8	38	26	48
9	25	27	28
10	11	28	44
11	42	33	46
13	29 (10K ohms)	35	50
14	18	36	51

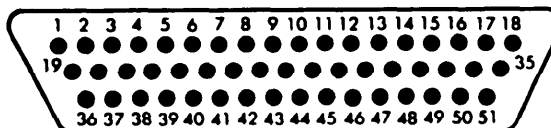

EL9LQ-1000-98

MDM51PSB



3-33. SELF-TEST CONNECTORS (cont)

3-33

SELF-TEST CONNECTOR 13083966-89 WIRE LIST

FROM	TO	FROM	TO
6	27	25	22
22	25	27	6

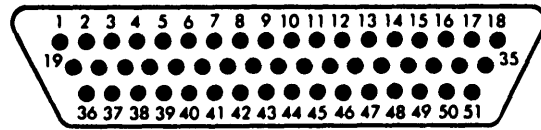

EL9LQ-1000-98

**MDM51PSB**

SELF-TEST CONNECTOR 13083970, 13083970-19, AND 13083970-29 WIRE LIST

---

<b>FROM</b>	<b>TO</b>
<b>Center Pin</b>	<b>Shield</b>
<b>Shield</b>	<b>Shell</b>

---

3-33. SELF-TEST CONNECTORS (cont)

3-33

SELF-TEST CONNECTOR 13083972-19 WIRE LIST

FROM	TO	FROM	TO
A	B	R	S
B	C	S	T
C	D	T	U
D	E	U	V
E	F	V	W
F	G	W	X
G	H	X	Y
H	J	Y	Z
J	K	a	c
K	L	c	Z
L	M	d	b
M	N	e	d
N	P	f	e
P	R	g	f
			g
			h

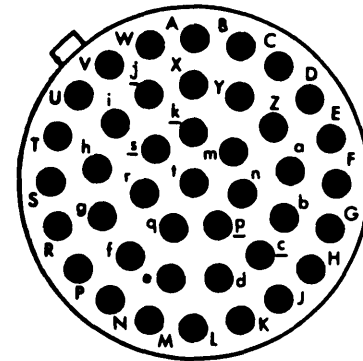

EL9LQ-1000-458

MS3471L20-41SW



3-33. SELF-TEST CONNECTORS (cont)

SELF-TEST CONNECTOR 13083972-29 WIRE LIST

1	8
3	40
4	41
5	37
6	9
10	13
11	12
14	38
15	36
16	35
17	18
18	19
19	23
21	31
22	32
23	27
27	33
28	29

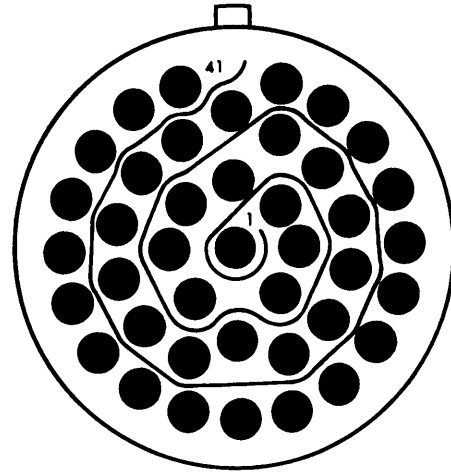

EL9LQ-1000-114A

M83723/814H 20418

SELF-TEST CONNECOR 13083972-39 WIRE LIST

FROM	TO	FROM	TO
A	C	S	Z
A	X (121 ohms)	T	X
B	D	U	j
C	A	V	i
D	B	W	Y
E	F	X	A (121 ohms)
F	E	X	T
F	G	Y	W
G	F	Z	S
G	H	a	M
H	G	b	f
H	J	c	g
J	H	d	h
J	L	e	k
K	e	f	b
L	J	g	c
M	a	h	d
N	t	i	V
P	R	j	U
R	P	t	N

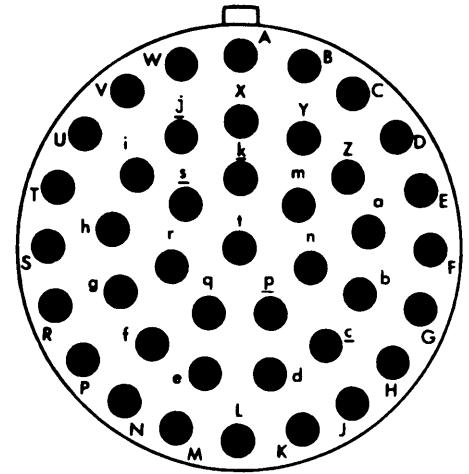

EL9LQ-1000-40A

**MS3471L20-41S**



3-33. SELF-TEST CONNECTORS (cont)

3-33

SELF-TEST CONNECTOR 13231098 WIRE LIST

FROM	TO
E1	E4 (10 ± 0.5 KOHMS)
E2	E4 (10 ± 0.5 KOHMS)
E3	E4 (10 ± 0.5 KOHMS)
E5	E4 (10 ± 0.5 KOHMS)
E6	E4 (10 ± 0.5 KOHMS)
E7	E4 (10 ± 0.5 KOHMS)

SELF-TEST CONNECTOR 13231518 WIRE LIST

FROM	TO
A	B
B	C
C	D
D	E
E	F
F	J

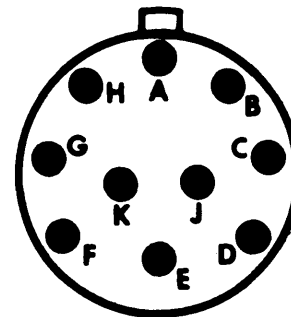

EL9LQ-1000-139

MS27468T13B98P

SELF-TEST CONNECTOR 13231539 WIRE LIST

FROM	TO
Center Pin	Shield (10K ohms)

3-33. SELF-TEST CONNECTORS (cont)

SELF-TEST CONNECTOR 13231685 WIRE LIST

FROM	TO	FROM	TO
1	7	25	109
2	92 (10K ohms)	29	33
2	93 (10K ohms)	32	46
2	95 (10K ohms)	34	44
2	111 (10K ohms)	35	124
3	110	70	127
4	23	79	115
5	58	80	81 (10K ohms)
6	106	89	125 (10K ohms)
7	45	90	101 (10K ohms)
8	57	96	114 (10K ohms)
9	24	97	119 (10K ohms)
10	32	98	112 (10K ohms)
11	14	99	100 (10K ohms)
12	22	102	118 (10K ohms)
13	94	103	116 (10K ohms)
16	126	104	121 (10K ohms)
19	47	105	113 (10K ohms)
20	91 (10K ohms)	117	128 (10K ohms)
21	56	120	123 (10K ohms)

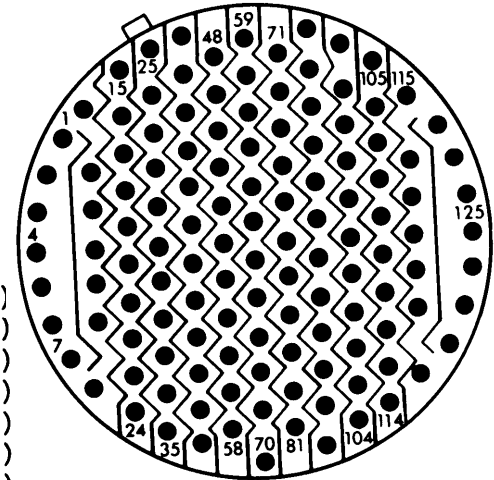

EL9LQ-1000-142  
MS27466P25B35PC

SELF-TEST CONNECTOR 13231686 WIRE LIST

FROM	TO	FROM	TO
1	2 (10K ohms)	24	112
1	109 (10K ohms)	30	90
1	110 (10K ohms)	34	37
1	120 (10K ohms)	42	95
1	128 (10K ohms)	44	56
3	6	45	47
4	19	57	94
5	9	79	80
7	33	81	93
8	46	91	126 (10K ohms)
10	58	92	126 (10K ohms)
11	115	96	111
12	117	101	105
14	17	103	108
16	102	104	127
18	70	107	121
20	106	113	119
21	123	114	124
22	25	116	118
23	35	122	125

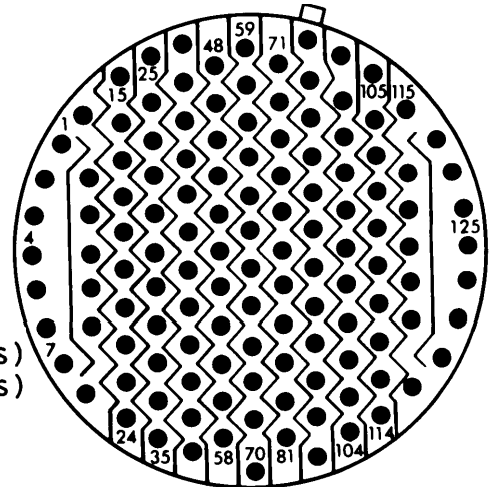

EL9LQ-1000-141  
MS27466P25B35PA



3-33. SELF-TEST CONNECTORS (cont)

3-33

SELF-TEST CONNECTOR 13231699 WIRE LIST

FROM	TO	FROM	TO
1	8	58	102 (10K ohms)
2	16	58	120 (10K ohms)
4	23	67	109 (10K ohms)
6	119 (10K ohms)	69	126 (10K ohms)
7	46 (10K ohms)	74	79 (10K ohms)
11	28	80	82 (10K ohms)
12	39	81	83
13	68	84	85
14	46 (10K ohms)	86	90 (10K ohms)
15	17	87	91 (10K ohms)
18	107	94	95
24	46 (10K ohms)	96	97
25	47	99	112 (10K ohms)
26	81 (10K ohms)	100	118 (10K ohms)
26	93 (10K ohms)	103	123 (10K ohms)
27	115	105	110
33	70	106	111
35	83	116	117
36	71	122	124
38	125	127	128 (10K ohms)

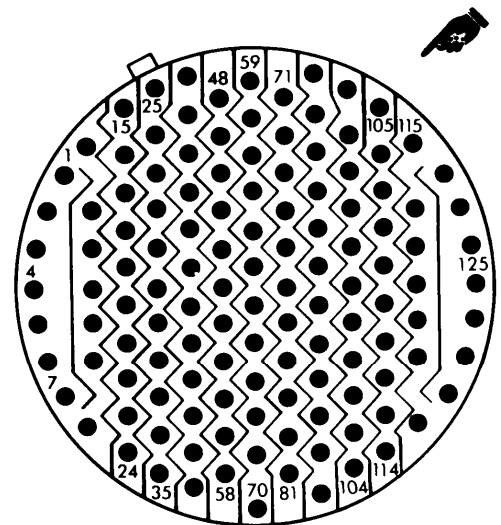

EL9LQ-1000-142

MS27466P25B35P

SELF-TEST CONNECTOR 13231709 WIRE LIST

FROM	TO
b	X
HH	AA

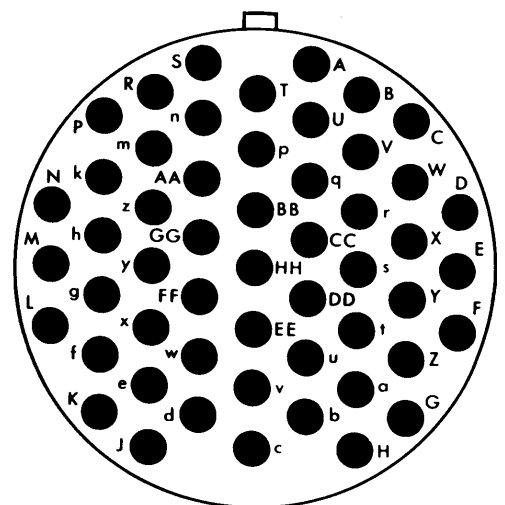

EL9LQ-1000-75

MS27468T23B53P

SELF-TEST CONNECTOR 13231710 WIRE LIST

FROM	TO
Z	V
b	q
m	HH
n	AA
w	u
x	t
y	k
z	v
M	K
N	d
P	c
U	J
X	p
Y	r
Z	s

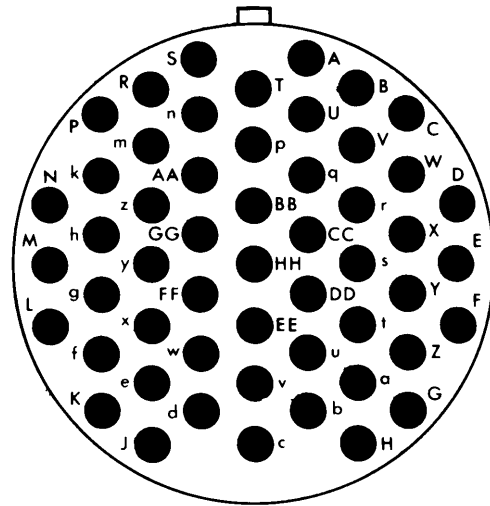

EL9LQ-1000-75

MS27466T23B53P

SELF-TEST CONNECTOR 13234711 WIRE LIST

FROM	TO
1	13
2	12
3	26
4	19
5	11
6	25
7	30
8	24
8	A3 (100 ohms)
10	23
14	17
15	18
20	22
21	29
A1	A2

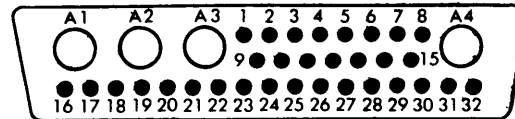

EL9LQ-1000-52

DDM36W4P

3-33. SELF-TEST CONNECTORS (cont)

3-33

SELF-TEST CONNECTOR 13231712 WIRE LIST

FROM	TO
A1	6

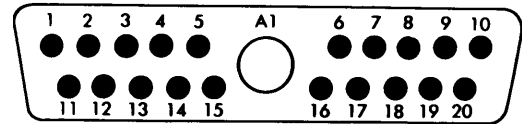

EL9LQ-1000-108

DBMM21W1P

SELF-TEST CONNECTOR 13231713 WIRE LIST

FROM	TO
1	9
2	5
3	4
6	10
7	8
9	12
11	A1

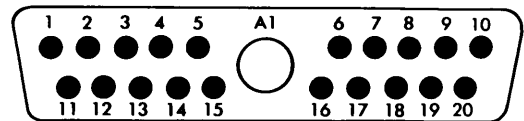

EL9LQ-1000-108

DBMM21W1P

SELF-TEST CONNECTOR 13231730 WIRE LIST

FROM	TO	FROM	TO
1	2	21	22
2	3	22	23
3	4	23	24
4	5	24	25
5	6	25	26
6	7	26	27
7	8	27	28
8	9	28	29
9	10	29	30
10	11	30	31
11	12	31	32
12	13	32	33
13	14	33	34
14	15	34	35
15	16	35	36
16	17	36	37
17	18	37	38
18	19	38	39
19	20	39	40
20	21		

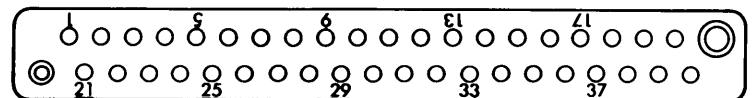

EL9LQ-1000-140

WRTAX40SEWTL



SELF-TEST CONNECTOR 13231731 WIRE LIST

FROM	TO
1	2
2	5
5	6
6	8
8	9
9	12
12	13
13	14
14	15
15	18
18	19
19	21
21	22
22	23
23	24
24	25

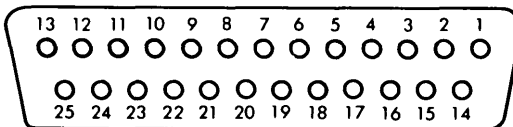

EL9LQ-1000-106

MDMV-25PSA



3-33. SELF-TEST CONNECTORS (cont)

3-33

SELF-TEST CONNECTOR 13231732 WIRE LIST

FROM	TO	FROM	TO
1	2	40	41
2	3	41	42
3	4	42	43
4	5	43	44
5	6	44	45
6	7	45	46
7	8	46	47
8	9	47	48
9	10	48	49
10	11	49	50
11	12	50	51
12	13	51	52
13	14	52	53
14	15	53	54
15	16	54	55
16	17	55	56
17	18	56	57
18	19	57	58
19	20	58	59
20	21	59	60
21	22	60	61
22	23	61	62
23	24	62	63
24	25	63	64
25	26	64	65
26	27	65	66
27	28	66	67
28	29	67	68
29	30	68	69
30	31	69	70
31	32	70	71
32	33	71	72
33	34	72	73
34	35	73	74
35	36	74	75
36	37	75	76
37	38	76	77
38	39	77	78
39	40		

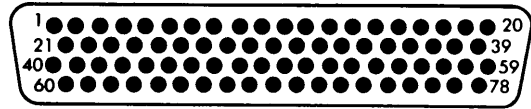

EL9LQ-1000-69

M24308/4-15

3-33. SELF-TEST CONNECTORS (cont)

3-33

SELF-TEST CONNECTOR 13231739 WIRE LIST

FROM	TO
1	2
2	4
4	5
5	6
6	7
7	8
8	9
9	10
10	11
11	13
13	14
14	15
15	16
16	17
17	18
18	20
20	21
21	22
22	23
23	24
24	25
25	26
26	27
27	28
28	29
29	30
30	31

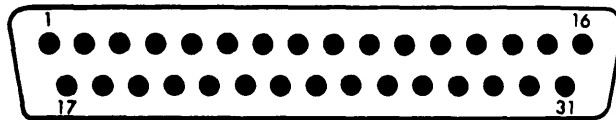

EL9LQ-1000-117

MDM-31PSB

SELF-TEST CONNECTOR 13231756 WIRE LIST

FROM	TO
CENTER	SHELL

SELF-TEST CONNECTOR 13231958 WIRE LIST

FROM	TO	FROM	TO
P1-1	P1-2	P1-21	P1-22
P1-3	P1-4	P1-23	P1-24
P1-5	P1-6	P1-25	P1-26
P1-7	P1-7	P1-27	P1-28
P1-9	P1-10	P1-29	P1-30
P1-11	P1-12	P1-31	P1-32
P1-13	P1-14	P1-33	P1-34
P1-15	P1-16	P1-35	SPL1
P1-17	P1-18	P1-36	SPL1
P1-19	P1-20	P1-37	SPL1

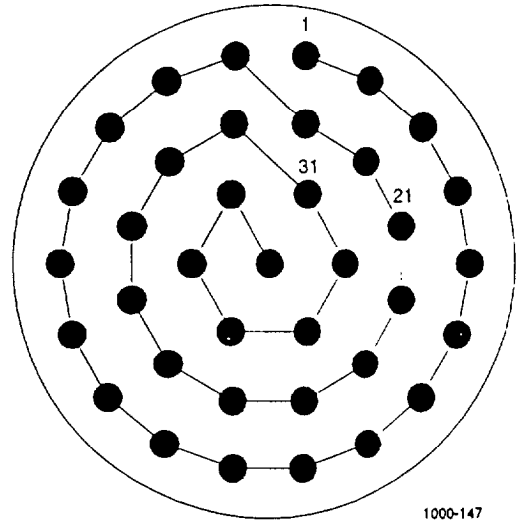

SELF-TEST CONNECTOR 13231963 WIRE LIST

FROM	TO	FROM	TO
P1-1	P1-2	P1-21	P1-22
P1-3	P1-4	P1-23	P1-24
P1-5	P1-6	P1-25	P1-26
P1-7	P1-8	P1-27	P1-28
P1-9	P1-10	P1-29	P1-30
P1-11	P1-12	P1-31	P1-32
P1-13	P1-14	P1-33	P1-34
P1-15	P1-16	P1-35	SPL1
P1-17	P1-18	P1-36	SPL1
P1-19	P1-20	P1-37	SPL1

D38999/26WD35PA  
D38999/26WD35PN





3-34. TEST FIXTURES

3-34

This task provides wiring data for test fixtures where applicable. Some test fixtures are only mechanical and some are mechanical and electrical. These test fixtures are used in various TPSs when additional handling/mounting is necessary beyond that of the other interface devices. They are listed in numerical order according to part number.

	Page
Terminal Box Assembly 13082747 Wire List . . . . .	3-668.7
Optical - HOD & IVD Alignment Assembly 13083078-39 Wire List . . . . .	3-672
Electrical Equipment Cabinet Assembly 13231501 Wire List . . . . .	3-678
Tubexial Fan Assembly 13231670 Wire Diagram . . . . .	3-679



3-34. TEST FIXTURES (cont)

3-34

TERMINAL BOX ASSEMBLY 13082747 WIRE LIST

FROM	TO	WIRE SIZE	SIGNAL/FUNCTION
E9	R1-E5	22	GROUND
P1	R1-E1	26	TO GATE A2A2-J3
P1	R3-E7	26	TO GATE A2A2-J3
P2	R4-E4	26	TO DIGITIZER A2A1 CHA A
P3	R4-E8	26	TO MONITOR
P4	R2-E2	26	TO UUT P5
R1-E1	P1	26	TO GATE A2A2-J3
R1-E5	E9	22	GROUND
R1-E5	R2-E6	26	TO UUT P5
R2-E2	P4	26	TO UUT P5
R2-E2	R3-E3	26	
R2-E6	R1-E5	26	
R3-E3	R2-E2	26	
R3-E3	R4-E4	26	
R3-E7	P1	26	TO GATE A2A2-J3
R4-E4	P2	26	TO DIGITIZER A2A1 CHA A
R4-E4	R3-E3	26	
R4-E8	P3	26	TO MONITOR

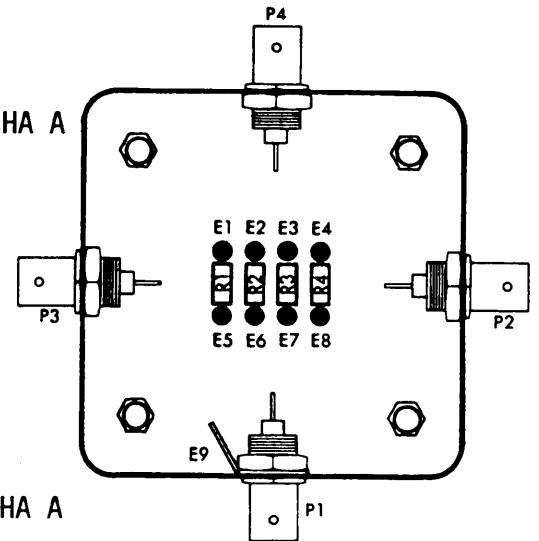

E19LQ-1010-68A

OPTICAL - HOD & IVD ALIGNMENT ASSEMBLY 13083078-39 WIRE LIST

FROM	TO	WIRE ID	WIRE SIZE
E3	SPL10		20
E6	PS1-E2	98	20
H/LD-E3*	E3		
H/LD-E4*	SPL10		
H/LD-E5*	J2-1	87	24
J2-1	H/LD-E5*	87	24
J2-2	SPL10	88	24
J2-3	P5-19	37	24
J2-4	P5-12	38	24
J2-6	STP8		24
J2-10	P6-21	56	24
J2-11	P6-20	47	24
J2-12	STP10		24
J2-16	STP12		24
J2-19	PS1-E1	89	24
J2-20	SPL6	90	24
J2-21	SPL5	91	24
J2-23	SPL4	92	24
J2-24	PS1-E5	93	24
J2-25	P6-1	51	24
J2-27	P6-5	50	24
J2-28	P6-3	49	24
J2-30	P6-4	48	24
J2-31	S1-1	94	24
J2-32	P6-42	52	COAX
J2-34	P6-43	53	COAX
J2-36	P6-15	54	COAX
J3-A	P4-1	10	22
J3-B	P4-2	11	22
J3-C	P4-3	12	24
J3-D	P4-4	13	24
J3-E	P4-5	14	24
J3-F	P4-6	15	24
J3-G	P4-7	16	24
J3-H	P4-8	17	24
J3-K	SPL9	95	24
J3-L	SPL8	96	24

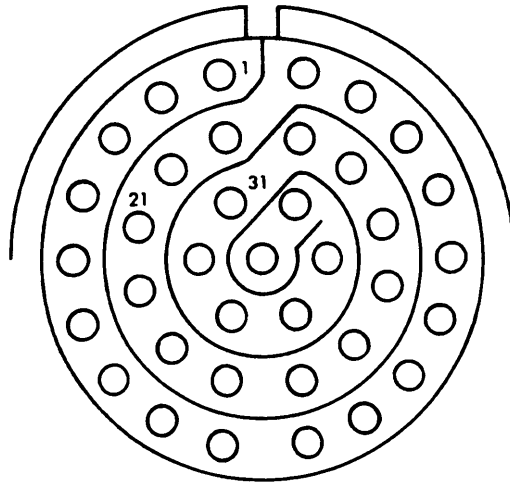

EL9LQ-1000-86

J2 - MS27468T15F35S

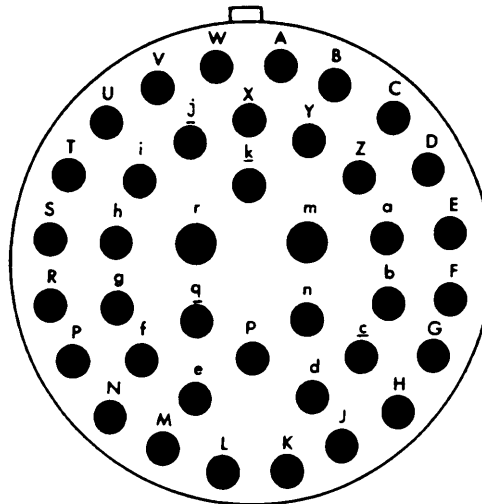

EL9LQ-1000-42A

J3 - MS27468T21F39P

3-34. TEST FIXTURES (cont)

OPTICAL - HOD & IVD ALIGNMENT ASSEMBLY 13083078-39 WIRE LIST (cont)

FROM	TO	WIRE ID	WIRE SIZE
J3-M	SPL7	97	24
J3-P	P4-14	21	24
J3-R	P6-37	64	24
J3-T	P6-9	60	COAX
J3-U	P6-49	65	24
J3-V	P6-36	63	24
J3-X	P4-21	22	24
J3-Y	SPL10		24
J3-Z	P6-22	59	24
J3-a	P6-23	58	24
J3-d	P6-24	57	24
J3-g	P4-30	24	24
J3-h	P4-31	25	24
J3-i	STP19	60	24
J3-k	P6-47	61	24
J3-m	P6-39	62	COAX
J4-A	P3-A	4	20
J4-B	P3-B	5	20
J4-C	P3-C	6	20
J4-D	P3-D	7	20
J4-E	SPL12	99	20
J4-F	SPL11	100	20
J5 (CTR COND)	P5-5	34	COAX
J6 (CTR COND)	P5-10	35	COAX
J7 (CTR COND)	P5-11	36	COAX
J8 (CTR COND)	P6-14	76	COAX
J9 (CTR COND)	P6-17	77	COAX
J10 (CTR COND)	P6-41	78	COAX
J11 (CTR COND)	P6-48	79	COAX
P2-A	P5-1	1	COAX
P2-B	P5-3	2	COAX
P2-C	P6-38	3	COAX
P3-A	J4-A	4	20
P3-B	J4-B	5	20
P3-C	J4-C	6	20
P3-D	J4-D	7	20
P3-E	SPL12	8	22
P3-F	SPL11	9	22

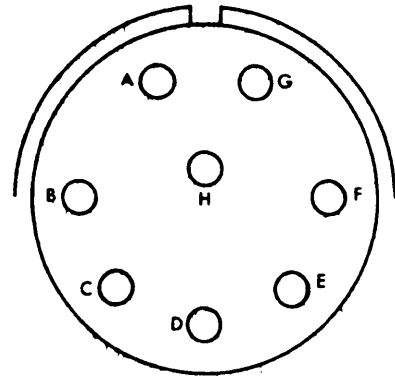

EL9LQ-1000-76

**J4 - MS27468T13F8S**

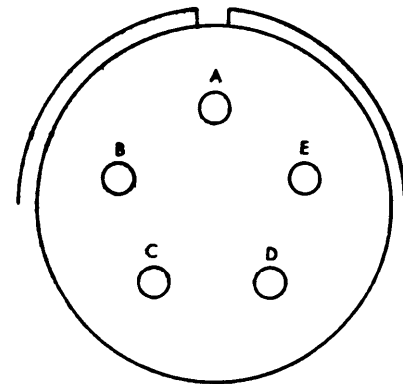

EL9LQ-1000-50

**P2 - MS27467T15F5S**

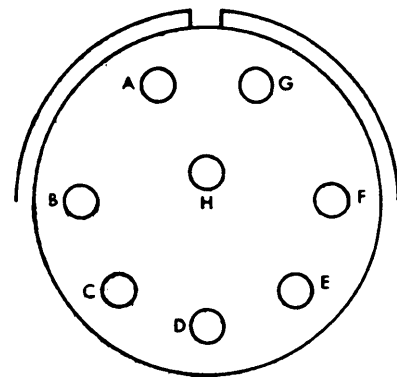

EL9LQ-1000-76

**P3 - MS27467T13F8S**

OPTICAL - HOD & IVD ALIGNMENT ASSEMBLY 13083078-39 WIRE LIST (cont)

FROM	TO	WIRE ID	WIRE SIZE
P4-1	J3-A	10	22
P4-2	J3-B	11	24
P4-3	J3-C	12	24
P4-4	J3-D	13	24
P4-5	J3-E	14	24
P4-6	J3-F	15	24
P4-7	J3-G	16	24
P4-8	J3-H	17	24
P4-10	SPL9	18	24
P4-11	SPL8	19	24
P4-12	SPL7	20	24
P4-14	J3-P	21	24
P4-15	P6-1	27	24
P4-16	P6-1	28	24
P4-17	P6-3	29	24
P4-18	P6-5	30	24
P4-19	P6-2	31	24
P4-20	P6-1	26	24
P4-21	J3-X	22	24
P4-22	SPL1	23	24
P4-23	P7-2	32	22
P4-24	P7-7	33	22
P4-30	J3-g	24	24
P4-31	J3-h	25	24
P5-1	P2-A	1	COAX
P5-3	P2-B	2	COAX
P5-5	J5 (CTR COND)	34	COAX
P5-7	SPL5	40	26
P5-8	SPL6	39	26
P5-9	SPL11	46	24
P5-10	J6 (CTR COND)	35	COAX
P5-11	J7 (CTR COND)	36	COAX
P5-12	J2-4	38	24
P5-14	STP1		24
P5-16	STP2		24
P5-18	STP4		24
P5-19	J2-3	37	24
P5-20	SPL4	41	26

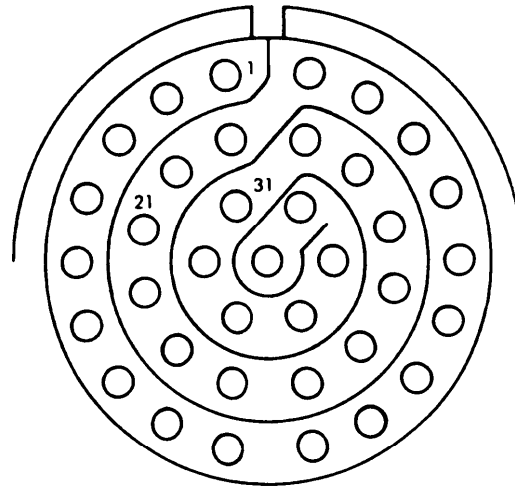

EL9LQ-1000-86

**P4 - MS27467T15F35S**

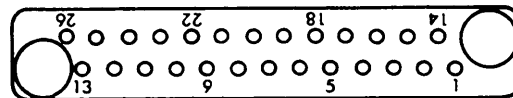

EL9LQ-1000-99

**P5 - WTA26SECJTL**

3-34. TEST FIXTURES (cont)

3-34

OPTICAL - HOD & IVD ALIGNMENT ASSEMBLY 13083078-39 WIRE LIST (cont)

FROM	TO	WIRE ID	WIRE SIZE
P5-21	P6-34	42	26
P5-22	SPL12	45	24
P5-23	STP5		24
P5-24	STP6		24
P5-25	P6-30	44	26
P5-26	P6-29	43	26
P6-1	J2-25	51	24
P6-2	S2-N0	85	24
P6-3	J2-28	49	24
P6-4	J2-30	48	24
P6-5	J2-27	50	24
P6-6	PS1-E2	82	24
P6-7	SPL6	66	26
P6-8	SPL4	68	26
P6-9	J3-T	60	COAX
P6-10	P4-16	28	24
P6-11	P4-15	27	24
P6-12	SPL2		24
P6-13	P4-20	26	24
P6-14	J8 (CTR COND)	76	COAX
P6-15	J2-36	54	COAX
P6-16	SPL1	55	24
P6-17	J9 (CTR COND)	77	COAX
P6-18	SPL8	72	26
P6-19	SPL9	71	24
P6-20	J2-11	47	24
P6-21	J2-10	56	24
P6-22	J3-Z	59	24
P6-23	J3-a	58	24
P6-24	J3-d	57	24
P6-25	P4-19	31	24
P6-27	PS1-E5	81	24
P6-28	S1-1	84	24
P6-29	P5-26	43	26
P6-30	P5-25	44	26
P6-31	SPL12	69	24

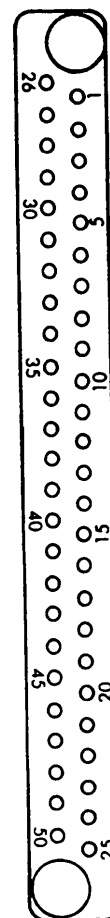

EL9LQ-1000-100

P6 - WTA50SECJTL

OPTICAL - HOD & IVD ALIGNMENT ASSEMBLY 13083078-39 WIRE LIST (cont)

FROM	TO	WIRE ID	WIRE SIZE
P6-32	SPL11	70	24
P6-33	SPL5	67	26
P6-34	P5-21	42	26
P6-35	P4-17	29	24
P6-36	J3-V	63	24
P6-37	J3-R	64	24
P6-38	P2-C	3	COAX
P6-39	J3-m	62	COAX
P6-40	SPL3	80	24
P6-41	J10 (CTR COND)	78	COAX
P6-42	J2-32	52	COAX
P6-43	J2-34	53	COAX
P6-44	SPL7	73	26
P6-45	P7-1	74	26
P6-46	P7-5	75	26
P6-47	J3-k	61	24
P6-48	J11 (CTR COND)	79	COAX
P6-49	J3-U	65	24
P6-50	P4-18	30	24
P7-1	P6-45	74	26
P7-2	P4-23	32	22
P7-5	P6-46	75	26
P7-7	P4-24	33	22
PS1-E1	J2-19	89	24
PS1-E2	P6-6	82	24
PS1-E2	E6	98	20
PS1-E2	PS1-E3	83	24
PS1-E3	PS1-E2	83	24
PS1-E5	J2-24	93	24
PS1-E5	P6-27	81	24
S1-1	P6-28	84	24
S1-1	J2-31	94	24
S1-N0	S2-1	86	24
S2-1	S1-N0	86	24
S2-N0	P6-2	85	24
SPL1	STP7		24
SPL1	STP9		24
SPL1	STP11		24
SPL1	STP18	60	24
SPL1	P6-16	55	24

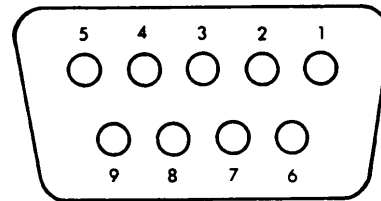

EL9LQ-1000-10

P7 - M24308/2-1



3-34. TEST FIXTURES (cont)

3-34

OPTICAL - HOD & IVD ALIGNMENT ASSEMBLY 13083078-39 WIRE LIST (cont)

FROM	TO	WIRE ID	WIRE SIZE	FROM	TO	WIRE ID	WIRE SIZE
SPL2	STP3		24	SPL10	P4-22	23	24
SPL2	STP13		24	SPL10	J2-2	88	24
SPL2	P6-12		24	STP1	P5-14		24
SPL3	STP14		24	STP2	P5-16		24
SPL3	STP15		24	STP3	SPL2		24
SPL3	STP16		24	STP4	P5-18		24
SPL3	STP17		24	STP5	P5-23		24
SPL3	P6-40	80	24	STP6	P5-24		24
SPL4	P5-20	41	26	STP7	SPL1		24
SPL4	P6-8	68	26	STP8	J2-6		24
SPL4	J2-23	92	24	STP9	SPL1		24
SPL5	P5-7	40	26	STP10	J2-12		24
SPL5	P6-33	67	26	STP11	SPL1		24
SPL5	J2-21	91	24	STP12	J2-16		24
SPL6	J2-20	90	24	STP13	SPL2		24
SPL6	P6-7	66	26	STP14	SPL3		24
SPL6	P5-8	39	26	STP15	SPL3		24
SPL7	P4-12	20	24	STP16	SPL3		24
SPL7	P6-44	73	26	STP17	SPL3		24
SPL7	J3-M	97	24	STP18	SPL1	60	24
SPL8	J3-L	96	24	STP19	J3-i	60	24
SPL8	P6-18	72	26				
SPL8	P4-11	19	24				
SPL9	P4-10	18	24				
SPL9	P6-19	71	24				
SPL9	J3-K	95	24				
SPL11	J4-F	100	20				
SPL11	P6-32	70	24				
SPL11	P5-9	46	24				
SPL11	P3-F	9	22				
SPL12	J4-E	99	20				
SPL12	P3-E	8	22				
SPL12	P5-22	45	24				
SPL12	P6-31	69	24				
SPL10	J3-Y		24				
SPL10	H/LD-E4*						
SPL10	H/LD-E3*						
SPL10	E3		20				

\* The high voltage load (H/LD) terminals are encapsulated with silicone, and are inaccessible.

ELECTRICAL EQUIPMENT CABINET ASSEMBLY 13231501 WIRE LIST

FROM	TO	WIRE ID	WIRE SIZE
E1	J1-A	1	20
E1	K1-X1	3	20
E2	J1-B	2	20
E2	K1-X2	4	20
E3(GND)	J1-J	9	20
J1-A	E1	1	20
J1-B	E2	2	20
J1-C	K1-A2	5	20
J1-D	R5-2	6	20
J1-E	R1-2	7	20
J1-F	R1-2	8	20
J1-J	E3(GND)	9	20
K1-A1	R1-1	2	20
K1-A2	J1-C	5	20
K1-A2	R5-2	10	20
K1-X1	E1	3	20
K1-X2	E2	4	20
R1-1	K1-A1	12	20
R1-1	R2-1	13	20
R1-2	J1-E	7	20
R1-2	J1-F	8	20
R1-2	R2-2	16	20
R2-1	R1-1	13	20
R2-1	R3-1	14	20
R2-2	R1-2	16	20
R2-2	R3-2	17	20
R3-1	R2-1	14	20
R3-1	R4-1	15	20
R3-2	R2-2	17	20
R3-2	R4-2	18	20
R4-1	R3-1	15	20
R4-2	R3-2	18	20
R4-2	R5-1	19	20
R5-1	R4-2	19	20
R5-1	R6-1	20	20
R5-2	J1-D	6	20
R5-2	K1-A2	0	20
R5-2	R6-2	11	20
R6-1	R5-1	20	20
R6-2	R5-2	11	20

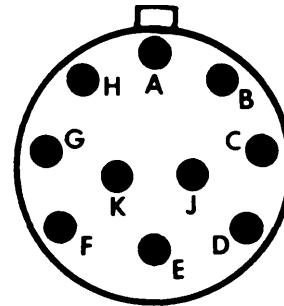

EL9LQ-1000-139

J1-MS27466T13B98P

TUBEAXIAL FAN ASSEMBLY 13231670 WIRE DIAGRAM

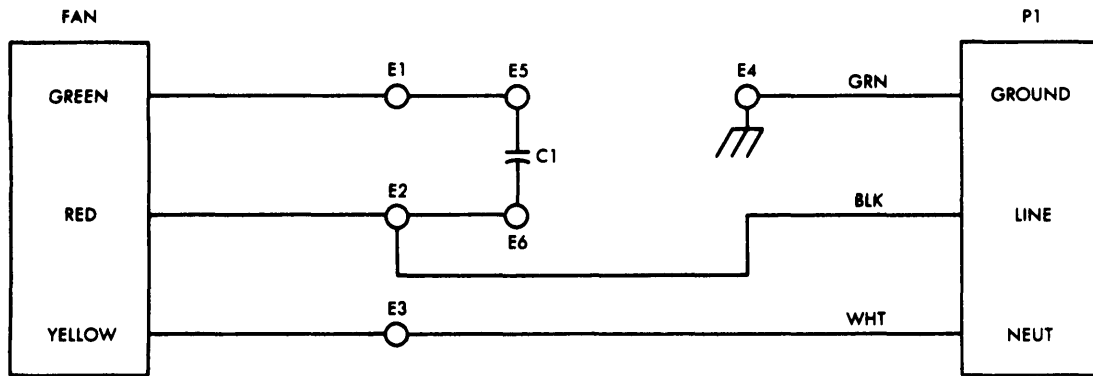

WIRING DIAGRAM

EL9LQ-1010-89

RECOMMENDED CHANGES TO EQUIPMENT TECHNICAL PUBLICATIONS



THEN... JOT DOWN THE DOPE ABOUT IT ON THIS FORM, CAREFULLY TEAR IT OUT, FOLD IT AND DROP IT IN THE MAIL!

**SOMETHING WRONG WITH THIS PUBLICATION?**

FROM: (PRINT YOUR UNIT'S COMPLETE ADDRESS)

DATE SENT

PUBLICATION NUMBER

PUBLICATION DATE

PUBLICATION TITLE

BE EXACT... PIN-POINT WHERE IT IS

PAGE NO.

PARA-GRAPH

FIGURE NO.

TABLE NO.

IN THIS SPACE TELL WHAT IS WRONG AND WHAT SHOULD BE DONE ABOUT IT:

TEAR ALONG PERFORATED LINE

PRINTED NAME, GRADE OR TITLE, AND TELEPHONE NUMBER

SIGN HERE:

DA FORM 2028-2  
1 JUL 79

PREVIOUS EDITIONS ARE OBSOLETE.

P.S.—IF YOUR OUTFIT WANTS TO KNOW ABOUT YOUR RECOMMENDATION MAKE A CARBON COPY OF THIS AND GIVE IT TO YOUR HEADQUARTERS.

